

Ophthalmic Instruments Catalogue

More than
40 Years in
Ophthalmology

QUALITY | SERVICE | INTEGRITY

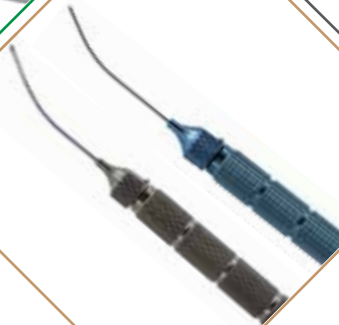
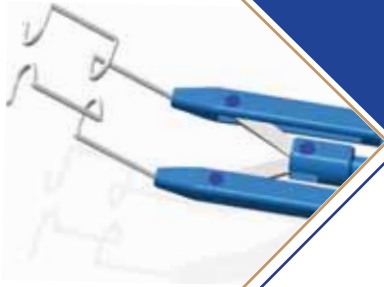

Most illustrations of this catalogue are nearly equal to the actual size of the product. Enlarged illustrations are used to display essential details and for easy perception.

Unless otherwise stated, surgical instruments are made of certified Stainless Steel and Titanium/Alloy raw materials.

Due to continuous developments and improvements, the given specifications, the products' design and construction are subject to change without any notice.

All photographs, illustrations and text of this catalogue should not be reproduced in any manner and all are protected by copyright. Reproduction in any form, to promote business (other than permitted reprints to promote the products of Appasamy Associates Private Limited and group of companies) are expressly prohibited.

RD-SI/CAT/Rev03.2020

To Our Valued Customers

We are delighted to present you our new catalogue, concise and covers almost all the products from our stable.

Our goal in presenting this new catalogue is to provide you with an easy reference of our exhaustive range of ophthalmic diagnostic equipments, surgical systems, laser systems, different types of microscopes for micro surgery, intraocular lenses (rigid and foldable), both disposable and re-usable surgical instruments, ophthalmic viscoelastic devices and ophthalmic pharmaceuticals.

We constantly upgrade the quality of our products and thank you for bringing your ideas so that we can help you making that idea into a reality.

We always strive to serve you the best and make things easier for you. We are proud of our products produced by us and the service we provide. With over 42 years in business, I take pride to offer you, “our valued customers”, our products with quality, combines with the best possible after sales services, with integrity and honesty.

On behalf of our partners and employees, everyone here at Appasamy Group of companies, we thank you for being our valued customer and supporting us all the way. We look forward to serve with gratitude.

Sincerely,

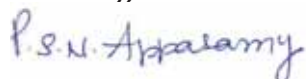

P. S. N. Appasamy,
Chairman



Established in 1978, Appasamy Associates Private Limited has grown to become the leading manufacturers of ophthalmic products in India. We manufacture almost all the products for your day to day needs that include ophthalmic diagnostic equipments and surgical systems, ophthalmic lasers, intraocular lenses, surgical instruments and pharmaceuticals.

Over four decades of sincere dedication and hard work, had resulted in bringing most of the modern state-of-the-art technology into our production processes, thus helping ophthalmic surgeons and vision care professionals to buy the needed ophthalmic products at an affordable price. We are proud to have played a major role in making the Indian Ophthalmic Surgeons to achieve the CSR (Cataract Surgery Ratio) on par with developed nations. Our various diversified and dedicated R&D teams work round the clock to bring in creative state-of-the-art and innovative ophthalmic products. Appasamy Group spends almost 20% of its sales turnover into R&D to improvise the existing products and develop new innovative products.

Our manufacturing facilities are in Chennai (Tamil Nadu), Pondicherry, Kolkata (West Bengal) and Baddi (Himachal Pradesh). Our sales offices are widespread in more than 50 locations and our service centres are located throughout India by which we can reach the doorsteps of every ophthalmic surgeon practicing in India. We export to more than 140 countries and exhibit our products in all the trade and scientific exhibitions conducted by different ophthalmic associations all over the world.



QUALITY ASSURANCE



Our skilled QA professionals ensure the compliances are in place to meet the statutory and regulatory requirements. Appasamy Groups' manufacturing facilities are ISO 13485 certified by notified bodies of European Union. We also meet the required provisions of council directive MDD 93/42/EEC, as amended and directive 2007/47/EC as transposed in the national laws of the Member States. We are also preparing ourselves to meet the stringent provisions of the new Medical Devices Regulations, to be implemented from May 2020, by the member states of European Union. Most of our products are CE marked by respective notified bodies for sales in EU; some of the products are registered and listed with US FDA and some products are 510(K) approved and sold in the USA.



DESIGN & INNOVATION

- In house CAD technical design team
- Rapid new product development
- Bespoke designs to surgeons' requirements



HIGH VOLUME PRODUCTION

- 100% APPASAMY owned manufacturing facilities
- Over 500 direct and 1000 indirect technicians
- Highly efficient production systems



PRECISION ENGINEERING

- Precision tip manufacturing and adjustment
- Surgical Grade Stainless Steels (ISO 7153/1)
- Tolerance of +/- 0.03 micron
- Investment in latest technology to improve efficiency and accuracy



Testing And Quality Control

- Steels tested & analysed as per ISO and ASTM standards
- Highly trained engineers and chemists
- ISO 13485 & 93/42/EEC (CE)
- Traceability from raw material to finished product.



At your service since 1978



Clean room Manufacturing



Precision Manufacturing with CNC Machines



Tooling



Moulding Manufacturing



Clean room Packaging



Inspection & QC



Surgical Instruments Production



Research & Development

Precision Instruments hand-finished to "exacting standards" by well trained and experienced artisans



Appasamy Associates Private Limited can provide value addition on products against customer requests viz.,

Tips/platforms of Forceps and Jaws of Needle holders can be administered wear resistant coating using Tungsten Carbide. This hard-coat enhances best grip holding and prevents slipping, during fixation. This coating is compatible to all methods of Sterilization

Vast majority of our Forceps and Needle holders are made using proprietary grade of Stainless Steel which has extremely good Corrosion resistance due to low inclusions.

TABLE OF CONTENTS

Catalogue Number Prefix	Description	Page Number
<hr/>		
AA 1000 Series	Speculums	02-10
	Retractors	12-13
	Scleral Depressors	14-15
	Knives	16
	Dissectors	17
	Spuds	17-18
	Lens Manipulators	18-25
	Nucleus Rotators Double End	25-27
	Spatulas	28-33
	Iris Hooks	33-34
	Fixation Rings	34-35
	Mucles Hooks	35-36
	Lens Expressors	36-37
	Curettes and Spoons	37-38
	Polishers & Lens Loops	38-40
	Cautery	40-41
	Nucleus Dividers	41-42
	Phaco Choppers	42-45
<hr/>		
AA 2000 Series	Corneal Trephines & Graft Holders	48
	Calipers	49-50
	Incision Gauges	50-51
	Incision Markers	51-56
	Pupil Dilators	57
	LASEK & DSEK Instruments	57-60
	DMEK & DALK	61-62
	LASIK Instruments	62-63
	Vitreo Retinal Spatulas & Peelers	64-67
	Toric Marker	67-70
<hr/>		
AA 3000 Series	Iris Forceps	73
	Colibri Forceps	74
	Hoskin Forceps	75-76
	Corneal Forceps	77
	Suturing Forceps	78

Catalogue Number Prefix	Description	Page Number
AA 3000 Series	Tissue Forceps	78
	Fixation & Superior Rectus Forceps	79-80
	Conjunctiva Forceps	81
	Cilia Forceps	82
	Capsular Forceps	82-83
	Muscle Forceps	83
	Chalazion & Trachoma Forceps	84-85
	Lens Holding Forceps	85-88
	Foldable IOL Forceps	88-91
	Tying Forceps	92-94
	Capsulorhexis Forceps	95-97
	LASIK Forceps	97
	Jewelers Forceps	98
	Foreign Body Removal Forceps	99
	Prechop Forceps	100-101
	Mosquito / Artery Forceps	102-103
Towel Clamp Forceps	103-104	
Vitreous / Vitreo Retinal	104-108	

AA 4000 Series	Corneoscleral Scissors - Left, Right	110
	Corneoscleral Scissors Universal	111-112
	Micro Iris Scissors	112-113
	Conjunctiva Scissors	113-114
	Vannas & Capsulotomy Scissors	114-116
	Vitreous Scissors	116 & 120
	Eye & Stitch Scissors	117-118
	Tenotomy Scissors	118
	Strabismus Scissors	119
	Enucleation Scissors	119

Catalogue Number Prefix	Description	Page Number
AA 5000 Series	Superior Rectus Needle Holders	122
	Castroviejo Needle Holders	122-123
	Barraquer Needle Holders	123-124
	Troutman Needle Holders	124-125
	Blade Breakers	125
	Blade Handles	126
	Intraocular Surgical Knives	127-132
AA 6000 Series	Bone Punches	134
	Corneoscleral Punches	135
	DCR / Lacrimal Trephine	135-136
	Lacrimal Probe	137
	Lacrimal Intubation Sets	137-138
	Lacrimal Dilators	138
AA 7000 Series	Lacrimal Cannulas	141
	Air Cannulas	142
	Anterior Chamber Cannulas	143
	A/C Maintainer	144
	Hydrodissection Cannulas	145
	Hydrodelineation Cannulas	146
	Irrigating Cannulas	146-147
	Aspirating Cannulas	148-149
	Irrigating / Aspirating Cannulas	150-156
	Needles	157-158
	Cystotomes	158-159
	Capsule Polisher Cannulas	159-161
	Irrigating Vectis Cannulas	162-163
	Irrigating Lens Manipulator Cannulas	163-164
	Cyclodialysis Cannulas	164
	LASIK Cannulas	165-167
Vitreo-Retinal Instruments	167-175	
AA 8000 Series	Stainless Steel Boxes	179-180
	Plastic Boxes	180-182
Phaco Surgery Accessories	Phaco Accessorieslar	184
	Phaco Handpieces	185

Catalogue Number Prefix	Description	Page Number
Phaco Surgery Accessories	Pinky Ball	186
	Bipolar Forceps	186-187
	Eraser	187
	Phaco Tips	188
	Bimanual I/A Handpiece	189
	Co-Axial I/A Handpiece	191
	Irrigating Nucleus Choppers	193
<hr/>		
Disposable	Disposable Instruments	196-211
<hr/>		
Instrument Sets	Microsurgery Cataract & IOL Set	214
	Microsurgery Cataract Set (Compact)	215
	Microsurgery IOL Set (Compact)	216
	Extracapsular Cataract Extraction Set (ECCE)	217
	Microsurgery Small Incision Non-Phaco Set	218
	Microsurgery Ecce-Phaco Emulsification Set	219
	Intracapsular Cataract Extraction Set (ICCE)	220
	Microsurgery Glaucoma Set	221
	Microsurgery Corneal Transplant Set	222
	Microsurgery LASIK Set	223
	Microsurgery Lid Set	224
	Microsurgery Chalazion Set	225
	Microsurgery Muscle Set	226
	Microsurgery Pterygium Set	227
	Microsurgery Lacrimal Set (DCR)	228
	Vitreo-Retinal Posterior Segment Set	229
	Microsurgery Retina Set	230
	Foreign Body Removal Set	231
	Microsurgery Enucleation Set	232
	Femtosecond Cataract Set	233
	Endothelial Set (DSAEK Set)	234
	Deep Anterior Lamellar Keratoplasty (DALK) Set	235
	DMEK Set	236
	Implantable Contact Lens Set (ICL)	237
	LASIK Retreatment Set	238
	Limbal Relaxation Incision (LRI) Set	239

Catalogue Number Prefix	Description	Page Number
Instrument Sets	Phakic Lens Set	240
	Femtosecond Lasik Set	241
	Intra Corneal Stromal Ring (ICSR) Set	242
	Toric Iol Set	243
	Minor Surgery Set	244
	Phaco 1.8mm - Bimanual (MICS)	245
	Phaco 2.2mm-Comics Prechop	246
	Phaco 2.8mm-Cataract Clear Corneal Set	247
	Manual Phaco Fracture Cataract Extraaction Set (MSICS)	248
	Oculoplastic Set – Titanium	250
	Corneal Transplantation Set – Titanium	251
	Lid Set – Titanium	252
	LRI Set – Titanium	253
	Glaucoma Set – Titanium	254
	Pterygium Set – Titanium	255
	Phacoemulsification Set – Titanium	256
	Strabismus Surgery Set – Titanium	257
	COMICS Surgery Set – Titanium	258
	Enucleation / Evisceration Set – Titanium	259
	Femtolasik Set – Titanium	260
	Femtosecond Cataract Set – Titanium	261
	Universal Instruments For Vitreoretinal Surgery Set –Titanium	262
	DLEK Set – Titanium	263
	Muscle Set – Titanium	264
	MSICS Set – Titanium	265
	Intra Corneal Stromal Ring (ICSR) Set – Titanium	266
	LASIK Set – Titanium	267
	"Deep Anterior Lamellar Keratoplasty (DALK)" Set – Titanium	268
	"Endothelil Transplantation DSEK/DSAEK/DMEK"Set – Titanium	269
	ECCE Set – Titanium	270
	ICL Set – Titanium	271
	LASEK Set – Titanium	272
	Chalazation Set – Titanium	273
	Toric Iol Set – Titanium	274
	MICS Set - Titanium	275

SPECULUMS

Wire Speculums

Eye Speculums

Irrigating Speculums

LASIK Speculums

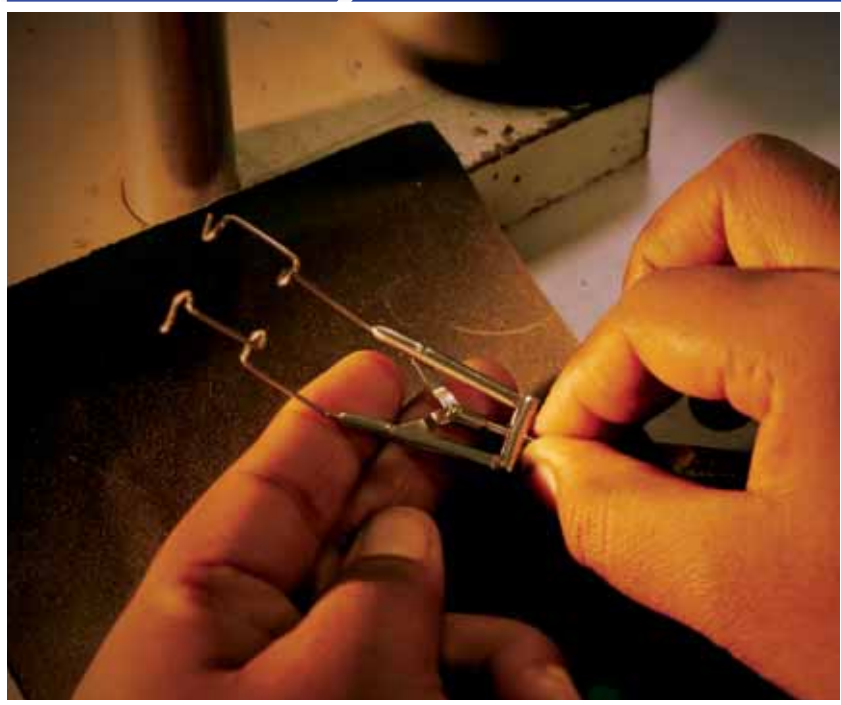
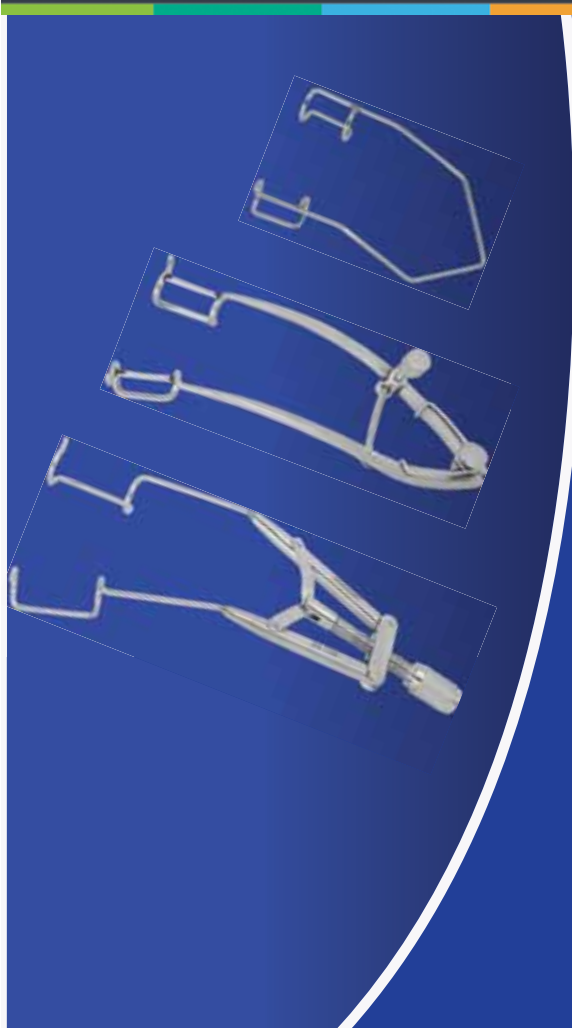

Barraquer

Wire speculum
size 5 mm blade
AA 1004 / AAT 1004 Extra small



Barraquer

Wire speculum
size 8 mm blade
AA 1005 / AAT 1005 Small

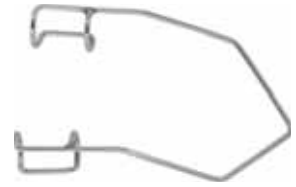

Barraquer

Wire speculum
size 12 mm blade
AA 1006 / AAT 1006



Barraquer

Nasal wire speculum
size 15 mm blade
AA 1008 / AAT 1008

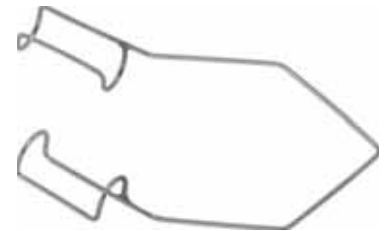

Barraquer

Wire speculum
size 15 mm blade.
AA 1009 / AAT 1009 Large
AA 1010 / AAT 1010 Heavy wire, Large

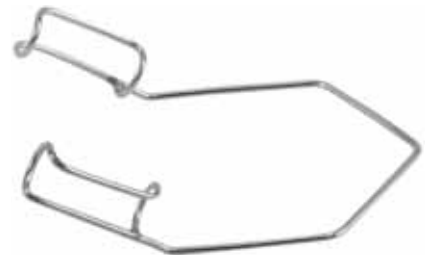

On Request

Pannu-Barraquer

Aspirating speculum
size 15 mm blade.
AA 1012



Barraquer

Wire speculum
with solid blades
size 8 mm blade
AA 1015 / AAT 1015 Small
size 13 mm blade
AA 1016 / AAT 1016 Large



Alfonso

Wire speculum
with finger grips
size 4 mm, closed blades
AA 1018

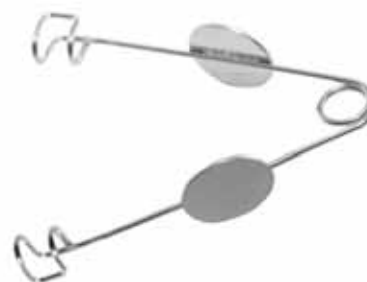

Kratz-Barraquer

Wire speculum
size 6 mm blade
AA 1019 / AAT 1019 Extra Small



Kratz-Barraquer

Wire speculum
with open blades for phaco surgery
size 10 mm blade.
AA 1020 / AAT 1020 Small
size 15 mm blade
AA 1025 / AAT 1025 Large

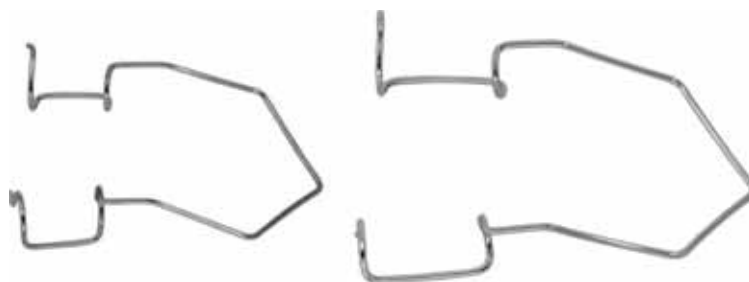

Kalpesh

Wire speculum
heavy wire, Large
size 14 mm blade
AA 1026 / AAT 1026

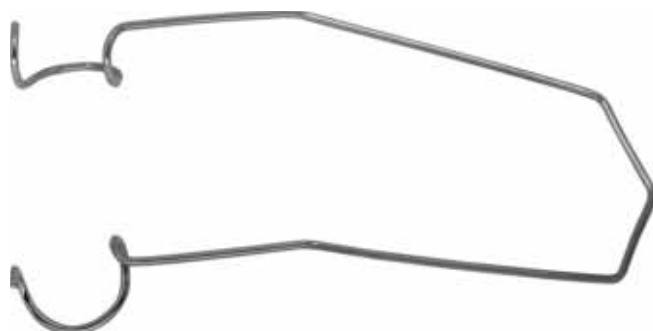

Pannu-Kratz Barraquer

Aspirating speculum
size 15 mm blade
AA 1027



On Request

Kratz-Barraquer

Wire speculum with wings
size 15 mm blade
AA 1030 / AAT 1030

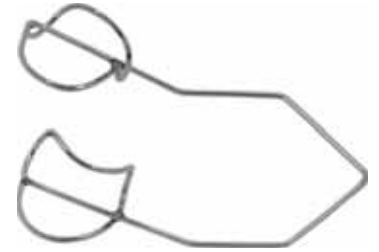

On Request

Nevyas Wire Speculum

size 12 mm blade
AA 1031 / AAT 1031



Infant

Wire speculum
size 4 mm blade
AA 1035 / AAT 1035



Infant

Wire speculum, Large
size 5.5 mm blade
AA 1037 / AAT 1037

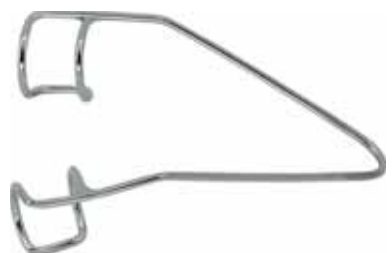

On Request

On Request

McIntyre

Wire speculum
with gently curved springs
"V" shaped blades

AA 1040 / AAT 1040 closed blades

AA 1045 / AAT 1045 open blades

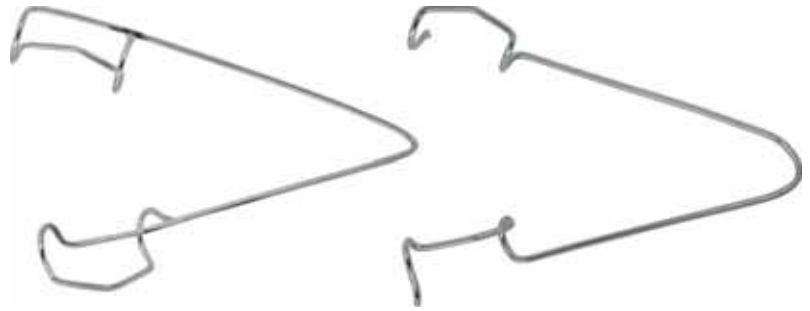

On Request

Thornton-Barraquer

Wire speculum
15 mm round wing blades
to lift and retract the lids away from the globe
eliminating external pressure

AA 1050 / AAT 1050



On Request

Grandon-Barraquer

Wire speculum
with suture notches or holes
to obtain additional
traction for upper lid

AA 1055 / AAT 1055 wire blades

AA 1056 / AAT 1056 solid blades

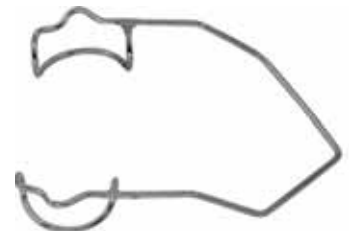

Tennant

Lid retractor
may be clamped to
surgical drape
with suture or elastic band

AA 1060 / AAT 1060 wire blades, Pair

AA 1061 solid blades, Pair



On Request

Sauer

Lid speculum

AA 1065 for infants

AA 1070 for premature infants



Cook

Eye speculum
solid with locking screw

AA 1075 Small #1

AA 1076 Medium #2

AA 1077 Large #3



Murdock

Eye speculum
fenestrated with locking screw

AA 1080 Small #1

AA 1081 Medium #2

AA 1082 Large #3



On Request

Lieberman

Irrigating speculum
with six ports
for temporal approach

AA 1085 Nasal

AA 1086 Temporal



On Request

Lieberman

Aspirating speculum
"V" shaped blades
with six ports
for temporal approach

AA 1087 Nasal

AA 1088 Temporal



Clark

Eye speculum
open blades

AA 1090 / AAT 1090 Small

AA 1095 / AAT 1095 Large



Williams

Eye speculum
open blades

AA 1100 / AAT 1100 Small

AA 1105 / AAT 1105 Large



Weiss

Eye speculum
open blades

AA 1110 / AAT 1110 Small

AA 1115 / AAT 1115 Large



Lancaster

Eye speculum
solid blades

AA 1120 / AAT 1120



Agarwal

No anesthesia
self retaining eye speculum
solid blades

AA 1125 / AAT 1125



Lester Burch

Eye speculum
solid blades

AA 1130



Castroviejo

Eye speculum
open blades

AA 1140 / AAT 1140 Small #1

AA 1142 / AAT 1142 Medium #2



Fishkind - Castroviejo

Lid speculum
with open blades for
phaco surgery
AA 1144 / AAT 1144



On Request

McPherson

Eye speculum
solid blades
with vertical suture posts
AA 1145



On Request

Guyton-Park

Eye speculum
with vertical suture posts
and canthus hook
AA 1150 solid blades
AA 1155 fenestrated blades



On Request

Maumenee-Park

Eye speculum
with canthus hook
and blade locking screw
AA 1160 solid blades
AA 1165 fenestrated blades



On Request

Park

Eye speculum
AA 1170 solid blades
AA 1175 fenestrated blades



On Request

Arul

Phaco speculum
swivelling wire
AA 1176 Nasal
AA 1177 Temporal



On Request

Arul

Phaco speculum
fixed wire
AA 1178 Nasal
AA 1179 Temporal



On Request

Smirmaul

Eye speculum
individually adjustable
blades for elevating lids
AA 1180 solid blades
AA 1182 fenestrated blades



Lieberman - Tennant

Eye speculum
open blades
for temporal placement
AA 1183 / AAT 1183
Nasal
AA 1184 / AAT 1184
Temporal



Mueller

Lacrimal sac retractor
spring action with screw lock
3 X 3 sharp prongs
AA 1185



Lieberman - Tennant

Eye
solid blades
for temporal placement
AA 1186 / AAT 1186 Nasal
AA 1187 / AAT 1187 Temporal



Agricola

Lacrimal sac retractor
spring action with screw lock
3 X 3 semi sharp prongs
AA 1190



Castroviejo

LASIK speculum
AA 1195 / AAT 1195



Jerome Bovert

Reversible speculum
nasal & temporal fit
AAT 1196



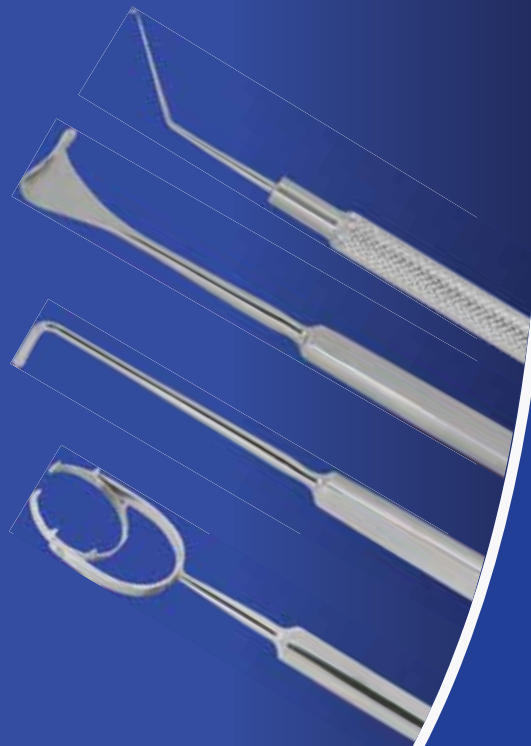

Retractors

Fixation Rings

Scleral Depressors

Dissectors & Spuds

Curettes & Spatula

IOL Manipulators

Nucleus Dividers

Phaco Choppers



Stevenson

Lacrimal sac retractor
3 X 3 blunt prongs
self-retaining adjustable spread
AA 1200



Stevenson

Lacrimal sac retractor
solid blades
self-retaining adjustable spread
size 15 mm blade
AA 1205



Goldstein

Lacrimal sac retractor
3 x 3 blunt prongs
AA 1210



On Request

Wright

Fascia needle
size 140 mm, sharp edge
AA 1215



Knapp

Lacrimal sac retractor
size 7 mm wide x 4 prongs
AA 1220 blunt



Knapp

Lacrimal sac retractor
size 7 mm wide x 4 prongs
AA 1225 sharp



Jaffe

Wire lid retractor
may be clamped to
surgical drape with suture
or elastic band
AA 1230 Small, Pair
size 8.5 mm blade
AA 1235 Large, Pair
size 14 mm blade



Clayman

Lid retractor
hinged type
size 11 mm blade
AA 1240 Pair



Dastoor

Iris retractor
3.5 mm wide
AA 1250 / AAT 1250 straight
AA 1255 / AAT 1255 left
AA 1256 / AAT 1256 right



Desmarres

Lid retractor
solid blades

size 0, 11 mm width
AA 1260 / AAT 1260

size 1, 12 mm width
AA 1261 / AAT 1261

size 2, 13 mm width
AA 1262 / AAT 1262

size 3, 14 mm width
AA 1263 / AAT 1263

size 4, 15 mm width
AA 1264 / AAT 1264



Schepens

Forked orbital retractor
AA 1270 / AAT 1270



Helveston

Tissue retractor
thin curved blade
size 7 mm wide
AA 1275 / AAT 1275
size 9 mm wide
AA 1276 / AAT 1276



Flieringa

Scleral fixation ring

AA 1280 set of 8 sizes (15-22 mm)

AA 1281 15 mm dia. **AA 1285** 19 mm dia.

AA 1282 16 mm dia. **AA 1286** 20 mm dia.

AA 1283 17 mm dia. **AA 1287** 21 mm dia.

AA 1284 18 mm dia. **AA 1288** 22 mm dia.

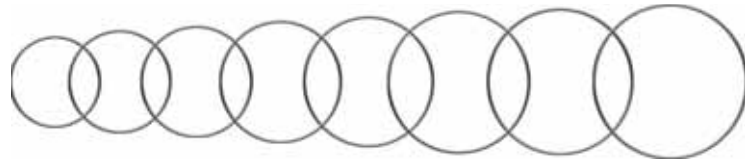

On Request

Goldman

Scleral fixation ring and blepharostat

AA 1290 adult size

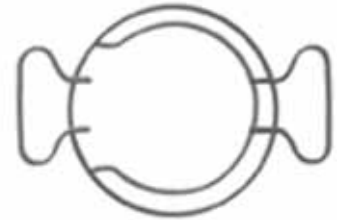

On Request

Gass

Scleral marker

1.5 mm diameter marking tip

AA 1295



On Request

Schepens

Scleral depressor with thimble

AA 1300 Small #8

AA 1305 Medium #10

AA 1307 Large #12



LASIK

Depressor

smoothly adheres flap to stromal bed in pupillary area

AA 1308 / AAT 1308



Schocket

Scleral depressor
double-end with pocket clip
AA 1310 / AAT 1310



On Request

Pediatric

Scleral depressor
AA 1311



On Request

Atul's

Pediatric scleral depressor
AA 1312

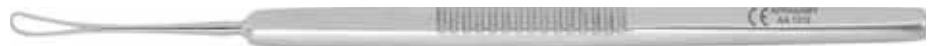

Chalazion Knife

Delicate
AA 1315 / AAT 1315



Micro Round Knife

for visco canalostomy 1.0 mm
AA 1316 / AAT 1316



Ziegler

Knife needle
AA 1320 3 mm
AA 1325 5 mm



Wheeler

Discission knife
18 mm X 1 mm cutting edge
AA 1330



Von Graefe

Cataract knife
1.5 mm X 25 mm sharp blades
AA 1340



On Request

Barraquer
Cataract knife
in sliding case
AA 1350



Paufique
Graft knife
angled tip
curved cutting edge
AA 1360



Emery
Cystotome
double-edge
for push and pull cutting
AA 1365 straight
AA 1366 angled



Tooke
Corneal knife
straight blade with
curved cutting edge
AA 1370 / AAT 1370



Gill
Corneal knife
curved cutting edge
straight
AA 1375 / AAT 1375
curved
AA 1380 / AAT 1380



Rollet Rugine
For lacrimal sac
AA 1385 / AAT 1385



Paton

Corneal dissector
hockey stick knife
AA 1390 / AAT 1390



Sato

Corneal knife
conical shaft straight
front 30 G / 0.3 mm
rear 20 G / 0.9 mm
AA 1391 / AAT 1391



Sato

Corneal knife, angled
front 30 G / 0.3 mm
rear 20 G / 0.9 mm
AA 1392 / AAT 1392



Dastoor

Lacrimal sac dissector, blunt
AA 1395



Lang's

Lacrimal sac dissector, sharp
AA 1397



Corneal Dissector

For intrastromal dissection
size 13.5 mm angled & 0.75 mm wide
angled, straight blade
AA 1398 / AAT 1398
angled, curved blade
AA 1399 / AAT 1399



Ellis

Foreign body spud
very thin, lightly curved
and rounded tip
AA 1400 / AAT 1400



Nicati

Foreign body spud
AA 1405 / AAT 1405



Golf Club

Foreign body spud
angled, lightly rounded tip
AA 1410 / AAT 1410



Francis

Foreign body spud
angled, flag shaped tip
AA 1415 / AAT 1415



Appa - Spud & Gouge

In reversible handle
for removing foreign bodies
AA 1420

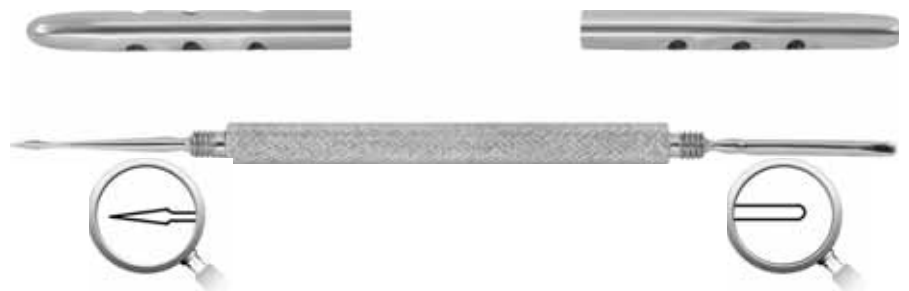

On Request

Algerbrush

Corneal rust
ring remover
battery powered
AA 1430 complete
AA 1435 extra burr 0.5 mm
AA 1440 extra burr 1.0 mm



Sinsky II

Lens manipulating hook
blunt tip, 0.2 mm diameter
AA 1460 / AAT 1460 straight
AA 1465 / AAT 1465 angled



AA - Stainless Steel, AAT - Titanium

QUALITY | SERVICE | INTEGRITY

Mahatme

Stop & Chop

1 mm length, round handle

0.25 mm diameter blunt tip

AA 1466 / AAT 1466 angled



Sinskey

Lens manipulating hook

round handle

0.25 mm diameter blunt tip

AA 1470 / AAT 1470 straight

AA 1472 / AAT 1472 angled



Harris - Sinskey

Lens manipulating hook

blunt tip, 0.25 mm diameter

flat handle

AA 1475 / AAT 1475 straight

AA 1477 / AAT 1477 angled

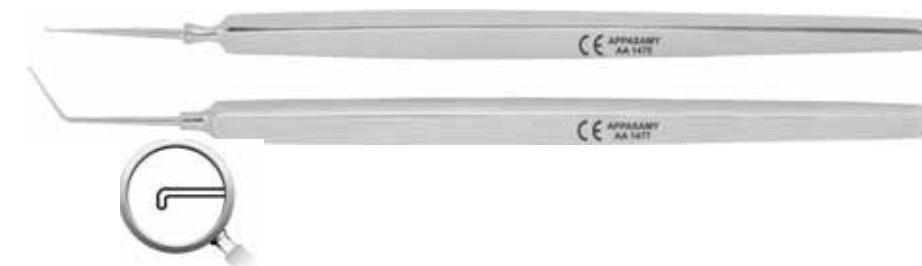

Toric Lens Manipulator

Allows gentle positioning of the lens haptics under the Iris plane. Tip maximizes surface contact with the lens which allows for easy manipulation. Posterior surface of the tip is micro sandblasted to achieve added surface contact.

AA 1478 / AAT 1478



Rentsch " Boat Hook"

Lens manipulator used as an capsule and Iris retractor

AA 1480 / AAT 1480 straight



Zaldivar Lens Manipulator

Double ended instrument with slight forked tips to place haptic under the Iris.

AA 1481 / AAT 1481



Pallikaris Lens Manipulator

Designed to place the haptics under the Iris.

AA 1482 / AAT 1482



Bahr - Maltzman

No hole IOL manipulating hook
tip width 0.80 mm

AA 1485 / AAT 1485 angled



Fenzi

Lens manipulating hook
blunt tip, 0.15 mm diameter

AA 1490 / AAT 1490 straight

AA 1495 / AAT 1495 angled



Maltzman-Fenzi

Modified no hole lens manipulator
0.15 mm diameter tip

AA 1500 / AAT 1500 angled



Jaffe

Lens manipulating hook
blunt tip, 0.15 mm diameter
angled to tip 1 mm

AA 1505 / AAT 1505



Kuglen

Iris hook
and lens manipulator
push-pull model, tip width 0.80 mm

AA 1510 / AAT 1510 straight

AA 1515 / AAT 1515 angled



Little

No hole lens manipulator
tip width 1.20 mm
AA 1520 / AAT 1520 straight
AA 1525 / AAT 1525 angled



Lewicky

Lens manipulating hook
blunt tip, 0.15 mm diameter
angled with curved shank
AA 1530 / AAT 1530



Kratz

Lens manipulating hook
blunt tip 0.15 mm diameter
angled to tip 10 mm
AA 1535 / AAT 1535



Hessburg

Lens pusher
AA 1545 / AAT 1545 straight



Aker

Lens pusher
smooth, fish mouth
shaped jaws
AA 1550 / AAT 1550 straight



Lester

Lens pusher
0.25 mm diameter tip, hourglass
shaped tip for IOL manipulation
AA 1555 / AAT 1555 straight
AA 1560 / AAT 1560 angled

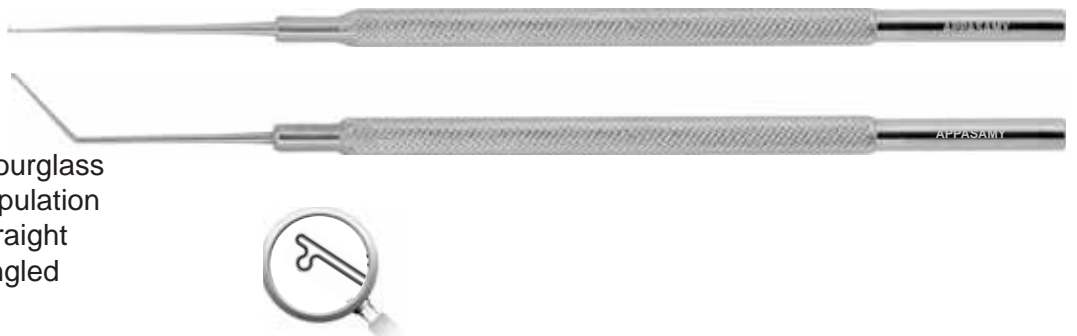

Lester

No hole lens manipulator
0.25 mm diameter tip,
hourglass shaped tip
for IOL manipulation
angled with curved shank
AA 1565 / AAT 1565

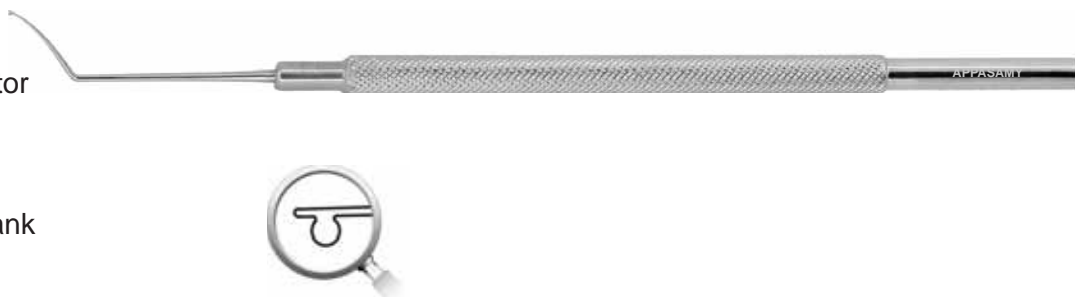

Maloney

IOL manipulator
vaulted shank
0.25 mm diameter tip
AA 1570 / AAT 1570



Lieberman

Micro finger
nucleus manipulator
right handed
AA 1575 / AAT 1575
left handed
AA 1576 / AAT 1576



Osher

'Y' hook no hole
lens manipulator
tip width 0.6 mm
AA 1580 / AAT 1580



Bechert

Nucleus rotator
blunt forked tip
angled to tip 7 mm,
tip width 0.7 mm
AA 1590 / AAT 1590



Rana

Phaco-chopper
for cracking the nucleus and
bring the nucleus pieces in the
center of pupil
AA 1591 / AAT 1591 size 0.65 mm



Jaffe-Bechert

Nucleus rotator
blunt forked tip
angled to tip 9 mm
tip width 0.70 mm
AA 1595 / AAT 1595



Kelman

Nucleus-wand
tip length 12 mm, 45° ang tip
for lens removal during
phacoemulsification
AA 1596 / AAT 1596



Akahoshi

Nucleus ball sustainer
is a companion instrument for
Akahoshi phaco prechopper.
The delicate manipulator
is designed to engage
the nucleus equator to stabilize
it and provide counter pressure
while the prechopper forceps is
being inserted into the nucleus core
AA 1597 / AAT 1597



Akahoshi

Nucleus ring sustainer
used to hold the hard nucleus firmly
during the prechopping technique
Ring diameter is 1 mm,
angle to tip 2.5 mm
AA 1597A / AAT 1597A



Caro

Manipulator
AA 1598 / AAT 1598



Graether

Side port manipulator
AA 1599 / AAT 1599



Yankee

Nucleus rotator
1.0 mm diameter
AA 1600 / AAT 1600



Connor Wand

Straight tip Ø 0.5 mm
AA 1601 / AAT 1601
with irrigation
AA 1601A / AAT 1601A



Connor Wand

Curved tip Ø 0.5 mm
AA 1602 / AAT 1602
with irrigation
AA 1602A / AAT 1602A



Connor Wand

Angled tip Ø 0.5 mm
AA 1603 / AAT 1603
with irrigation
AA 1604 / AAT 1604

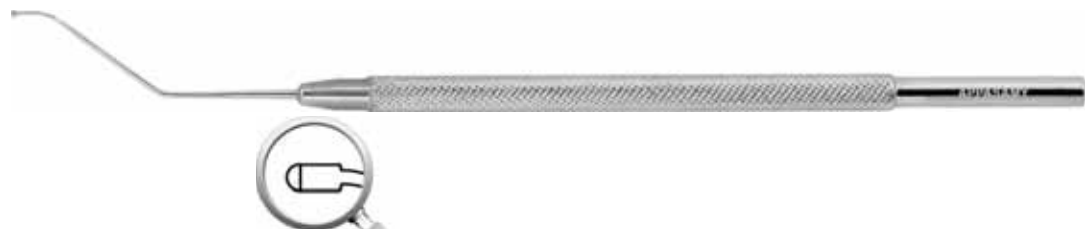

Koch

Phaco manipulator
and splitter
0.8 mm width
AA 1605 / AAT 1605



Mandel

Nucleus rotator
size 0.60 mm
AA 1610 / AAT 1610



Siepser

Endocapsular controller
trumpet shaped tip
AA 1612 / AAT 1612



Pisacano Hook

Nucleus rotator
flat disc shaped tip
AA 1613 / AAT 1613
horizontal
AA 1614 / AAT 1614
vertical



Kellan

Nucleus segmentor
paddle shaped to split nucleus
AA 1615 / AAT 1615



Tennant

Nucleus manipulator
ball shaped tip
AA 1620 / AAT 1620



Sinskey - Lester

For hole & no hole
lens manipulator
AA 1621 / AAT 1621



Arul - Sinskey

Lens manipulator hook
blunt tip 0.2 mm diameter &
phaco chopper blunt ball tip
45° angled
AA 1622 / AAT 1622



Chang-Seibel

Phaco chopper
A combination chopper with the
chang micro finger end and the
seibel vertical safety chopper
AA 1623 / AAT 1623



**Arul-Agarwal
Double End Phaco Chopper**

blunt ball tip 45° angled
and fully cutting edge

Arul - 1.0 mm inner cutting edge,
0.25 mm blunt polished tip

Agarwal - 1.0 mm inner cutting edge

AA 1624 / AAT 1624



(Agarwal)



(Arul)

Maloney

'Y' pusher & rod tip
for manipulating hard
and soft nuclei

AA 1625 / AAT 1625



Appasamy

Plain rod
11 mm angled
for Iris claw lens surgery / phackic
IOL surgery
size 0.5 mm

AA 1625A / AAT 1625A



Chang Quick Chop Combo

This double end instrument features
micro finger and pointed
"Quick chop" tip. Micro finger tip
for chopping & dividing the nucleus
and "Quick chop" tip for split the nucleus

AA 1626 / AAT 1626



Arul-Bechert

Double end
phaco chopper
blunt ball tip 45° angled & 'Y' rotator

AA 1627 / AAT 1627



Agarwal-Bechert

Double end
chopper fully cutting edge & 'Y' rotator

AA 1628 / AAT 1628



Barrett Duo

Phaco chopper & manipulator
1.0 mm inner cutting edge,
polished tip 0.25 mm & 0.8 mm dia.
AA 1629 / AAT 1629



Maloney

Nucleus rotator with
spatulated tip for
manipulating hard and soft nuclie
size 0.65 mm & 0.80 mm
AA 1630 / AAT 1630



Thomas Neuhann

'Y' Rotator & Phaco splitter
size 0.70 mm &
1.00 mm inner cutting edge, 1.3 mm tip
AA 1631 / AAT 1631



Thomas Neuhann

Iris Hook & nucleus splitter
size 0.75 mm tip &
1.0 mm inner cutting edge, 1.3 mm tip
AA 1632 / AAT 1632



Masket Phaco Spatula

Nucleus chopper & manipulator
size 1.0 mm Dia &
1.0 mm inner cutting edge, 1.35 mm tip
AA 1633 / AAT 1633



Katzen

For LASIK enhancements
this double end instrument
combines sinskey lens
manipulating hook and
biconvex spatula with
beveled notches
AA 1634 / AAT 1634



Kellan

Nucleus rotator
and IOL guide
AA 1635 / AAT 1635



Sinsky - Drysdale

Lens manipulating hook and
nucleus manipulator
size 0.2 mm dia. & 1.5 mm tip
AA 1636 / AAT 1636



Drysdale

Nucleus manipulator
size 1.0 mm tip
AA 1636A / AAT 1636A



Pettigrove

PRK marker and scraper
6.5 mm marker & spatula
for both marking and removing
the epithelium prior to PRK
AA 1637



Machat

Double ended
intralase spatula with 45° angled
sinsky hook
AA 1638 / AAT 1638



LASIK Flap Lifter

Combines a 45°angledinsky
hook and a thin hook with a
conical tip
AA 1639 / AAT 1639



Hirschman

Lens spatula
flat, 0.5 mm wide
with small notches for the
manipulating IOL's

AA 1640 / AAT 1640



Iris spatula

Malleable stainless steel spatula
1 mm wide blade

AA 1650 / AAT 1650



Barraquer

Iris spatula
round handle, smooth angled
tip width 0.25 mm dia. & 13 mm length

AA 1655 / AAT 1655

tip width 0.50 mm dia. & 13 mm length

AA 1656 / AAT 1656



Troutman - Barraquer

Iris spatula
angle to tip 15 mm length &
tip width 0.5 mm dia.

AA 1660 / AAT 1660



Fukasaku

LASIK spatula
for lifting and dissecting
the corneal flap
size 0.3 mm thickness, 10 mm length

AA 1665 / AAT 1665



Slade Femtosecond Spatula

Flat tip used to open the main and
side port incisions, made for
femtosecond laser procedure
size 0.25 mm width, 10 mm length

AA 1666 / AAT 1666



Castroviejo

Synechia spatula
double-ended, 0.5 mm wide
with semi-sharp tips
AA 1670 / AAT 1670

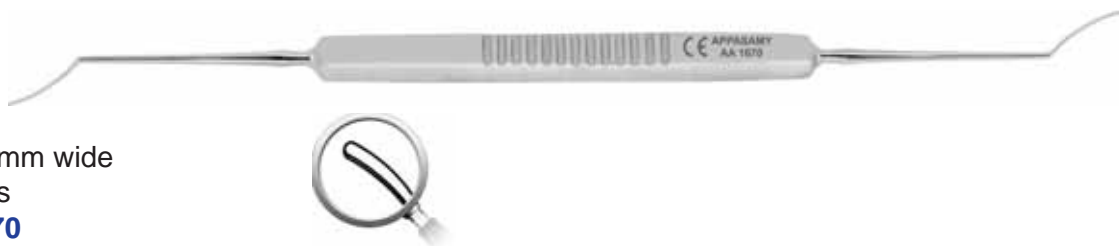

Girard

Synechia spatula
semi-sharp tip
0.5 mm wide, angled
AA 1675 / AAT 1675



Obstbaum

Lens spatula
0.25 mm wide, angled
AA 1677 / AAT 1677



Castroviejo

Cyclodialysis spatula
double-ended
AA 1680 / AAT 1680
0.25 mm wide
AA 1682 / AAT 1682
0.50 mm wide



Slade

LASIK retreatment spatula
1.6 mm wide
AA 1683 / AAT 1683



Koman Nair

Iris spatula
double ended
smooth 1 mm wide X 10 mm long
angled and 1 mm wide X 30 mm
long gently curved shaft
AA 1685 / AAT 1685



Castroviejo

Corneal transplant spatula, double-ended
AA 1690 / AAT 1690



Dastoor

Pupil and Iris repositior
AA 1695 / AAT 1695



Busin

Endothelial glide
funnel-shaped spatula cut-out
notch at tip
size 4.5 mm width
AA 1696 / AAT 1696



Green

Spatula
double-ended
long handle
AA 1700 / AAT 1700



Jaffe

Lens spatula
flat, smooth
0.5 mm wide
AA 1705 / AAT 1705



Paton

Spatula & spoon
AA 1710 / AAT 1710



Nordan

Capsule elevator
for in-the-bag
IOL placement
AA 1715 / AAT 1715



Wheeler

Double-ended spatula
lightly curved
AA 1720 / AAT 1720



Kimura

Spatula
AA 1725 / AAT 1725



Wecker

Iris Spatula
1 mm wide, 30 mm long
curved shaft
AA 1730 / AAT 1730



Knolle

Lens nucleus spatula
lightly curved, malleable tip
AA 1735 / AAT 1735



Jaeger

Lid plate
AA 1740 / AAT 1740



Trabut

Lid Plate
AA 1742



Stallard

Ptosis spatula

AA 1745 Small

AA 1746 Large



Graether

Collar button

Micro Iris retractor

tip size 0.75 mm

AA 1750 / AAT 1750 straight

AA 1755 / AAT 1755 angled



Bonn

Micro Iris hook

blunt tip

size 1.2 mm, 0.25 mm diameter

round handle

AA 1760 / AAT 1760

flat handle

AA 1765 / AAT 1765

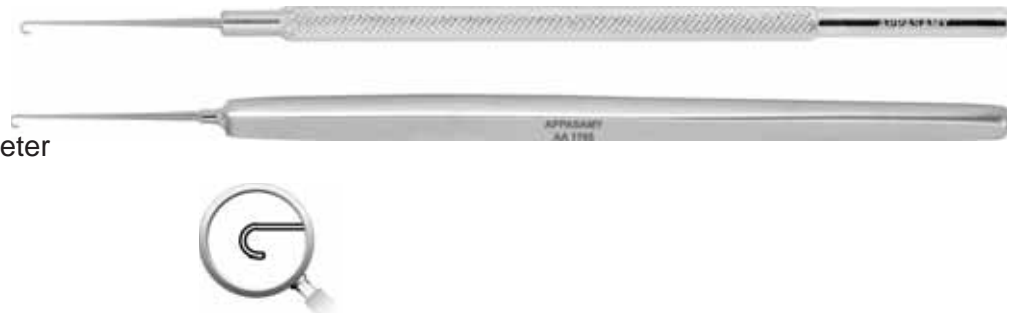

Jaffe-Knolle

Iris hook

very blunt

small, angled

size 1.5 mm, 0.25 mm dia.

AA 1770 / AAT 1770



Knolle

Iris hook

very blunt, straight

size 1.5 mm, 0.25 mm dia.

AA 1775 / AAT 1775



Shepard

Iris hook

small blunt, flat handle

AA 1780 / AAT 1780



Jaffe

Iris hook
small blunt, flat handle
AA 1790 / AAT 1790



Kuglen

Iris hook
and lens manipulator
clover leaf model
AA 1800 / AAT 1800 straight



Twist Hook

For scleral fixation
AA 1805



Fixation Hook

Double, sharp
AA 1810 2 X 1.5 mm Small
AA 1812 2.5 X 2 mm Large



Thornton

Globe fixation ring
multiple teeth
16 mm diameter
AA 1815 / AAT 1815



Thornton

Globe fixation ring
multiple teeth
16 mm diameter, 6 mm front opening
AA 1816 / AAT 1816



Shepard

Fixation ring
clear cornea incision
12 teeth, pivot swivelable,
16 mm diameter, 6 mm front opening
AA 1817 / AAT 1817



Appasamy

Globe fixation ring
with concentric grooves for stabilizing
the globe during PRK and LASIK procedures.
size outer dia. 15.75 mm, inner dia. 10.25 mm

AA 1818



Appasamy

Globe fixation ring
with concentric grooves for stabilizing
the globe and providing
counterpressure for clear
cornea phaco incisions and IOL insertion.
size outer dia. 15.5 mm, inner dia. 10.25 mm, open 2.3 mm

AA 1819



Stevens

Tenotomy hook
blunt, Small
size tip length 7.5 mm

AA 1820 / AAT 1820



Graefe

Muscle hook
AA 1825 / AAT 1825 size 1
AA 1826 / AAT 1826 size 2
AA 1827 / AAT 1827 size 3



Gass

Retinal detachment hook
with oval hole

AA 1830 / AAT 1830



Jameson

Muscle hook
AA 1835 / AAT 1835 Small
AA 1837 / AAT 1837 Large



Green
Muscle hook
AA 1840 / AAT 1840



Arruga
Lens extractor
AA 1845 / AAT 1845 right
AA 1846 / AAT 1846 left



Chavasse
Muscle hook
AA 1850 / AAT 1850



Culler
Rectus muscle hook
AA 1855 / AAT 1855



Smith
Lens expressor
AA 1860 / AAT 1860



Appasamy
Lens expressor
double-ended
AA 1862 / AAT 1862



Kirby
Lens expressor & vectis
AA 1865 / AAT 1865



Kirby
Muscle hook & vectis
AA 1865A / AAT 1865A



Kirby

Lens expressor & repositor
AA 1866 / AAT 1866



Kirby

Lens expressor & spatula
AA 1867 / AAT 1867



Kirby

Iris retractor & repositor
AA 1868 / AAT 1868
size 0.25 mm, 3.5 mm



Meyerhoefer

Chalazion curette
AA 1875 / AAT 1875
size 0, 1.50 mm dia.



AA 1876 / AAT 1876
size 1, 1.75 mm dia.



AA 1877 / AAT 1877
size 2, 2.25 mm dia.



AA 1878 / AAT 1878
size 3, 3.00 mm dia.



AA 1879 / AAT 1879
size 4, 3.50 mm dia.



Bunge

Evisceration spoon
AA 1880 / AAT 1880
Small, size 8 mm dia.
AA 1881 / AAT 1881
Large, size 12 mm dia.



Mule

Evisceration scoop
AA 1885 / AAT 1885 Small
AA 1886 / AAT 1886 Large



Wells

Enucleation spoon
AA 1890 / AAT 1890 Small
AA 1891 / AAT 1891 Large



On Request

McIntyre

Nucleus removal cannula
 with irrigation port
 size 2.5 mm width, 16 G
AA 1895



On Request

Daviel

Lens spoon
AA 1900 / AAT 1900 Small
AA 1901 / AAT 1901 big

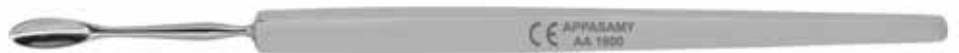

On Request

Barraquer

Lenticular spoon
 for corneal button transfer
 size 9 mm, 5 holes 1.5 mm dia.
AA 1905



Anis

Capsule scrubber
 gently curved flexible shank
 with roughened tip
AA 1906 ball tip, 0.75 mm
AA 1907 disc tip, 1.75 mm
AA 1908 reverse ball tip



Nightingale

Capsule polisher
1.75 mm dia. open ring
semi-sharp edge

AA 1910 / AAT 1910 anterior
AA 1911 / AAT 1911 posterior
AA 1912 / AAT 1912 12'O clock



Lewis

Lens loop
AA 1914 / AAT 1914
extra small, 4 mm width
AA 1915 / AAT 1915
small, 5 mm width
AA 1915A / AAT 1915A
angled, 5 mm width
AA 1916 / AAT 1916
large, 6 mm width



Appa - Snare

Nucleus dividing snare
complete set
AA 1917
spare snare (pkd/5)
size 5 mm width, 0.2 mm thickness
AA 1918



On Request

New Orleans

Lens loop
size 3.5 mm width
AA 1920 / AAT 1920



Wilder

Lens loop
size 3.0 mm width
AA 1925 / AAT 1925 serrated



Kansas

Lens loop
3 mm wide serrated,
medium curved
for small incision
nucleus fragment removal
AA 1930 / AAT 1930



Keener-Arlt

Lens loop
3 mm wide serrated strong
curve for Small
incision nucleus
fragment removal
AA 1935 / AAT 1935



Akahoshi/Wahab Pars Plana Levitator

Can be used to lift the
nucleus from the retina
20 gauge loop
dimensions 12 mm
AA 1936



On Request

Gills-Welsh

Lens loop and probe
with serrations
size 6.0 mm width
AA 1940



Morrison

Lens loop and probe
very thin
size 4.5 mm width, 1.7 mm dia.
AA 1945



Simcoe

Lens nucleus loop
Fine Serrations, strong curve
double-end
size 4.0 mm width
AA 1950



Cautery Ball Point

Stainless steel
AA 1960



Cautery Ball Point

Copper
AA 1961



Cautery Cone Type
Stainless steel
AA 1962



Cautery Cone Type
Copper
AA 1963



Kansas
Nucleus bisector
for manual Small incision surgery
size 11.0 mm length, 1 mm thickness
AA 1965 / AAT 1965



Alfonso
Nucleus trisector
1.5 mm wide used with
AA 1967 alfonso cutting
platform for manual
Small incision surgery
AA 1966



Alfonso
Cutting platform
used as a cutting block
for nucleus trisector
for manual Small incision
surgery, 2 mm wide
AA 1967



Kansas
Nucleus trisector
for manual Small incision surgery
size 4.0 mm wide, 10.0 mm length
AA 1970 right
AA 1972 left



Ravisankar
Nucleus trisector
9 mm length,
2.5 mm wide
AA 1973



Ravisankar

Nucleus vectis
serrated, 9 mm length, 2.5 mm wide
AA 1974



Kansas

Nucleus vectis solid,
used as a "cutting block" for
kansas nucleus
bisector and trisector
size 15.0 mm length, 3.0 mm wide
AA 1975 / AAT 1975 right
AA 1977 / AAT 1977 left



McIntyre

Nucleus bisector
For Small incision surgery
AA 1980 right
AA 1981 left



McIntyre

Nucleus trisector
for incision surgery
size 3.0 mm width, 12.0 mm length
AA 1982 right
AA 1984 left



McIntyre

Nucleus vectis
solid, used as a "cutting block"
for McIntyre nucleus
bisector and trisector
AA 1985 right
AA 1987 left



Chang

Microfinger phaco chopper
Curved finger-shaped tip
with defined inner edge for
horizontal chopping
size 0.3 mm tip, 2.0 mm length
AA 1988 / AAT 1988



Mohan Rajan

Micro combo chopper
pointed tips
vertical nucleus chopper

- AA 1989 / AAT 1989** 1.00 mm
- AA 1989A / AAT 1989A** 1.25 mm
- AA 1989B / AAT 1989B** 1.50 mm
- AA 1989C / AAT 1989C** 1.75 mm
- AA 1989D / AAT 1989D** 2.00 mm



Arul

Phaco chopper
1.0 mm inner cutting edge
0.25 mm blunt polished tip

- AA 1990 / AAT 1990** 15° angle
- AA 1991 / AAT 1991** 45° angle
- AA 1992 / AAT 1992** 60° angle



Agarwal

Phaco chopper
vertical nucleus chopper
fully cutting edge

- AA 1993 / AAT 1993** 1.00 mm
- AA 1993A / AAT 1993A** 1.25 mm
- AA 1993B / AAT 1993B** 1.50 mm



Verges

Phaco chopper
triple cutting edge
1.0 mm inner cutting edge
0.25 mm blunt polished tip

- AA 1994 / AAT 1994**



Appasamy

Phaco chopper & Iris retractor
2 mm cutting edge
blunt tip, 30° angle

- AA 1995 / AAT 1995**



Rosen

Phaco splitter
inner cutting edge & smooth blunt tip
size 0.15 mm tip, 0.35 mm dia.

- AA 1996 / AAT 1996**



Miyoshi

Nucleus dividing hook
for fine cutting
size 1.3 mm length, 0.4 mm tip
AA 1997 / AAT 1997 straight



Miyoshi

Nucleus dividing hook
for use with the right hand
size 1.3 mm length, 0.4 mm tip
AA 1998 / AAT 1998 Right



Miyoshi

Nucleus dividing hook
for use with the left hand
size 1.3 mm length, 0.4 mm tip
AA 1999 / AAT 1999 Left



Nagahara

Karate chopper
tip length 1.5 mm
spear shaped for ease of
insertion into the nucleus
AA 2000 / AAT 2000
for left hand surgeon
AA 2000A / AAT 2000A
for right hand surgeon
AA 2000B / AAT 2000B



Gillum

Side port splitter
tip length 1.5 mm
angled shaft 'C' shape for
entry from the side port,
overall length 120 mm
AA 2001 / AAT 2001



Gillum

Phaco splitter
tip length 1.5 mm
angled shaft 'S' shape for
entry from the tunnel incision
overall length 120 mm
AA 2002 / AAT 2002



Steinert

Nucleus chopper
curved tip length 1.5 mm
AA 2003 / AAT 2003



Mackool

Phaco chopper
delicate rounded tip
size 1.0 mm length
AA 2004 / AAT 2004



Seibel

Phaco chopper
size 1.5 mm length, 0.5 mm tip
AA 2005B / AAT 2005B right hand
AA 2005D / AAT 2005D left hand



Minu Mathen

Universal chopper
AA 2008 / AAT 2008 1 mm tip
AA 2008A / AAT 2008A 1.25 mm tip
AA 2008B / AAT 2008B 1.5 mm tip
AA 2008C / AAT 2008C 1.75 mm tip
AA 2008D / AAT 2008D 2 mm tip



Minu Mathen

Tunnel chopper
size 1.0 mm length, 0.25 mm tip
AA 2009 / AAT 2009







Corneal Trephines

Calipers

Markers

LASEK Instruments

LASIK Instruments

DSEK Instruments

Membrane Spatula



Castroviejo

Corneal trephine
with adjustable stop

- AA 2010** size 5 mm dia.
- AA 2011** size 5.5 mm dia.
- AA 2012** size 6 mm dia.
- AA 2013** size 6.5 mm dia.
- AA 2014** size 7 mm dia.
- AA 2015** size 7.5 mm dia.
- AA 2016** size 8 mm dia.
- AA 2017** size 8.5 mm dia.



- AA 2018** size 9 mm dia.
- AA 2019** size 9.5 mm dia.
- AA 2020** size 10 mm dia.
- AA 2020A** size 10.5 mm dia.
- AA 2021** size 11 mm dia.
- AA 2022** size 11.5 mm dia.
- AA 2023** size 12 mm dia.
- AA 2024** size 12.5 mm dia.

Appasamy

Corneal trephine
see through

- AA 2024A** size 5.5 mm dia.
- AA 2025** size 6 mm dia.
- AA 2026** size 6.5 mm dia.
- AA 2027** size 7 mm dia.
- AA 2028** size 7.5 mm dia.
- AA 2029** size 8 mm dia.

- AA 2030** size 8.5 mm dia.
- AA 2031** size 9 mm dia.
- AA 2032** size 9.5 mm dia.
- AA 2033** size 10 mm dia.
- AA 2033A** size 10.5 mm dia.
- AA 2034** size 11 mm dia.



Barraquer

Keratoplasty knife
pear-shaped

AA 2035



Dastoor

Keratoplasty spatula

AA 2040



Tudor Thomas

Corneal graft stand
brass chrome plated

AA 2050



(Reduced Image Shown)

Lieberman

Corneal cutting block
with hole in the center for release of air
and fluid underneath the donor button

AA 2060 Teflon

AA 2061 Silicone



DMEK Twin Block

Block consists of twin wells specially designed to hold the donor cornea and help surgeon in the donor tissue preparation.

AA 2062



Appasamy

Corneal transplant punch
this punch produces a symmetrical smooth, vertical cut when using with Appasamy trephine blade. The base of punch is provided with a cavity to hold the silicone block in the centre

AA 2065



On Request

(Reduced Image Shown)

Dastoor

Corneal graft holding forceps

AA 2070



On Request

Castroviejo

Caliper

20 mm spread

AA 2075 / AAT 2075 straight

AA 2080 / AAT 2080 curved

AA 2081 / AAT 2081 angled



Osher

Incision caliper

for internal measurement of cataract incisions from 1 to 10 mm

AA 2085



On Request

Appasamy

Fixed caliper

double end

AA 2086 size 2.8 & 5.00 mm

AA 2087 size 3.0 & 3.50 mm

AA 2087A size 3.0 & 5.20 mm

AA 2088 size 3.2 & 5.50 mm

AA 2088A size 3.5 & 4.00 mm

AA 2088B size 3.8 & 5.20 mm

AA 2089 size 5.5 & 6.00 mm



AA - Stainless Steel, AAT - Titanium

Galand

Incision marker

AA 2090 size 3 mm

AA 2096 size 6.5mm

AA 2097 size 4.5mm

AA 2098 size 7.5mm

AA 2099 size 5.5mm

AA 2099 size 6.5mm



Appasamy

Incision gauge

for measuring the incision size during phaco surgery (0.80 mm to 3.2 mm)

0.1 mm increments, set of 24 gauges

AA 2102

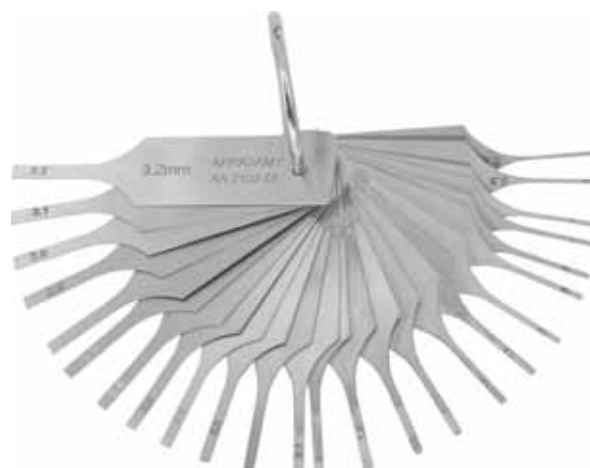

Corneo Punctal Gauge

AA 2103 / AAT 2103



On Request

Thorpe

Caliper

with markings

in 0.5 mm increments

AA 2105



On Request

Jameson

Caliper

chrome plated brass

AA 2110



Rule

Stainless steel

AA 2115



Deitz

Incision depth gauge
for corneal incisions
AA 2125 / AAT 2125
0.50 mm
AA 2127 / AAT 2127
0.55 mm



Thornton

Limbal incision ruler
with marking lines
spaced 1 mm apart
AA 2130



Grandon

T-Incision single marker
AA 2135 2.00 mm wide
AA 2136 2.50 mm wide
AA 2137 3.00 mm wide
AA 2138 4.00 mm wide
AA 2139 5.00 mm wide



Mendez

Degree gauge
for accurate axial
alignment of corneal
incision to correct
astigmatism 12 mm I.D
AA 2140 / AAT 2140



Appasamy

Fixation ring &
degree gauge
for globe fixation and
alignment of corneal
incision 12 mm I.D., 17.5 mm O.D
(with teeth)
AA 2141



Appasamy

Fixation ring and degree gauge for globe fixation and alignment of corneal incision 12 mm I.D., 17.5 mm O.D (with teeth) handle in 90° position for temporal approach
AA 2142



Irrigating Marker

Suitable for ICSR surgery
AA 2144



Bores

Axis marker used with mendez degree gauge to mark the axis in which corneal incisions for correction of astigmatism are to be made
AA 2145

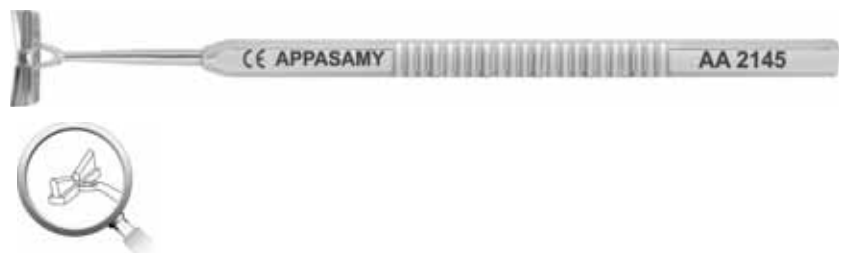

Tunnel Zone Marker

Marking tunnel for future ring position with initial lines for incisions 40 degree angled to handle size 2.0 mm ring height
AA 2146 / AAT 2146 7.2 mm
AA 2147 / AAT 2147 8.0 mm



Nordan-Ruiz

Trapezoidal marker for surgical correction of astigmatism blades spaced 1 mm apart
AA 2150 2.50 mm wide
AA 2151 3.00 mm wide
AA 2152 4.00 mm wide
AA 2153 5.00 mm wide



Thornton

Double corneal ruler
for astigmatism surgery
used to impress a
symmetrical pattern of
ruled markings on the
cornea for placement
of transverse incisions
from 0.5 mm to 5.0 mm
in length

AA 2155 for 6-8 mm optic zones

AA 2156 for 5-7 mm optic zones



Corneal Marker

For LASIK surgery
for identification and realignment
of the lamellar flap

AA 2157



Hofmann

T-Incision marker
with two 5 mm long marking blades

AA 2160 5 mm spread

AA 2162 6 mm spread

AA 2164 7 mm spread

AA 2166 8 mm spread



Bores

Parallel marker
for surgical correction of
astigmatism blades spaced
0.75 mm apart 4 blades

AA 2170



Bores

Step ladder marker
used to mark a 3 line
pattern on the corneal for
surgical correction of astigmatism
1 mm spacing, 1.5 mm wide

AA 2175



Maloney

Astigmatism marker
2 lines, 3 mm long spaced
1 mm apart

AA 2180



Appa

LASIK marker
for proper flap re-alignment
pointed for perfect placement
over pupil opening

AA 2182



Maloney

Intra-operative keratometer
for qualitative measurement
of astigmatism

size 31 mm width, 22 mm height

AA 2183 / AAT 2183

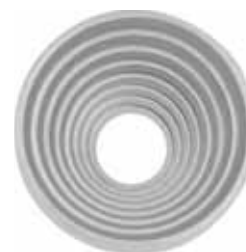

Mandel

Intra-operative keratometer
3.5 mm dia. ring used to project
a circular image on the cornea
for qualitative evaluation of
surgically induced astigmatism

AA 2185



Hoffer

Optic zone marker
with extra fine cross hairs

AA 2190 3.00 mm dia.

AA 2191 3.25 mm dia.

AA 2192 3.50 mm dia.

AA 2193 3.75 mm dia.

AA 2194 4.00 mm dia.

AA 2195 4.25 mm dia.

AA 2196 4.75 mm dia.

AA 2197 5.00 mm dia.

AA 2198 5.50 mm dia.

AA 2199 5.75 mm dia.

AA 2200 6.00 mm dia.

AA 2202 7.00 mm dia.

AA 2203 8.00 mm dia.



Thornton

Optic zone marker
with centering pin
very low profile

- AA 2210** 3.00 mm dia.
- AA 2211** 3.25 mm dia.
- AA 2213** 3.50 mm dia.
- AA 2214** 4.00 mm dia.
- AA 2215** 4.25 mm dia.
- AA 2216** 4.50 mm dia.
- AA 2217** 4.75 mm dia.
- AA 2218** 5.00 mm dia.



Grene

Visual axis marker
with 0.5 mm dia.
concave tip

- AA 2220**



Optical Zone Marker

Used to mark visual center for ICSR
implantation procedure
double ended
size total angled length 11.0 mm, tip 0.5 mm

- AA 2221**



McDonald

optic zone marker for
photo refractive
keratectomy double-end
with extra fine cross hairs
6.5 and 7.0 mm dia.

- AA 2225**



Bores

Optic zone marker

- AA 2230** 2.75 mm dia.
- AA 2231** 3.00 mm dia.
- AA 2232** 3.25 mm dia.
- AA 2233** 3.50 mm dia.
- AA 2234** 3.75 mm dia.
- AA 2235** 4.00 mm dia.
- AA 2236** 4.25 mm dia.
- AA 2237** 4.50 mm dia.
- AA 2238** 4.75 mm dia.



- AA 2239** 5.00 mm dia.
- AA 2241** 6.00 mm dia.
- AA 2245** 7.00 mm dia.
- AA 2249** 8.00 mm dia.

Berkeley

Optic zone marker
double-end

AA 2250 3.00 & 3.25 mm dia

AA 2252 3.50 & 3.75 mm dia

AA 2254 4.00 & 3.25 mm dia

AA 2256 4.00 & 5.00 mm dia



Osher-Neumann

Radial marker
with extra fine cross hairs

AA 2260 4 blades

AA 2261 6 blades

AA 2262 8 blades

AA 2263 10 blades

AA 2264 12 blades

AA 2265 16 blades



Anis

Suture placement marker for
corneal grafts, 8 radial
blades with 8.0 mm
centre opening

AA 2270



Capsulorhexis Marker

Central ring with non- marking
posts for alignment with limbus
(for 5.5 mm CCC)

AA 2283 6 mm diameter marking ring
(for 5.0 mm CCC)

AA 2284 5.5 mm diameter marking ring



Henderson

Toric alignment marker
with atraumatic
disc-shaped marking
surfaces at 3,6 & 9 O' Clock

AAT 2286



Marking Pen

Gentian violet

AA 2300 fine tip

AA 2305 broad tip



Micro Beehler Pupil Dilator

Iris Dilators

straight, 20 G,

3 stretching points of pupil

AA 2351



Micro Beehler Pupil Dilator

Iris Dilators

curved, 20 G,

3 stretching points of pupil

AA 2352



Beehler Pupil Dilator

Iris Dilators. Straight,
4 stretching points of pupil for
3 mm incision.

AA 2353



Beehler Pupil Dilator

Iris Dilators. Curved,
4 stretching points of pupil for
3 mm incision.

AA 2354 curved



LASEK Hockey Knife

Can be used to detach
epithelium from the incision by
the sharp anterior part of
the knife and to reposit the
epithelium after ablation by
the blunt part of the knife
size 5.5 mm L, 45° angled tip, 1.6 mm width

AAD 2400

Disposable sterile condition



LASEK
Epithelial detaching spatula
AA 2405 / AAT 2405



LASEK
Epithelial micro hoe
AA 2410



LASEK
Epithelial flap
repositioning spatula
AA 2415 / AAT 2415



LASEK
Bow dissector
AA 2420



LASEK
Alcohol well
AA 2425 8 mm & 8.5 mm
AA 2426 9 mm & 9.5 mm



LASEK Trephine
270° semi-sharp edge,
90° cutout for flap hinge
AA 2430 8 mm & 8.5 mm
AA 2431 9 mm & 9.5 mm



ICSR Tunnel Maker

Lift the cornea to insert the tunnel maker beneath the guide

AA 2432 left

AA 2433 right



ICSR Tunnel Maker

Double end

AA 2434 / AAT 2434 small

AA 2434A / AAT 2434A big



LASEK Trephine & Well

270° Semi-sharp edge,
90° cutout for flap hinge

AA 2435 8 mm trephine & 8.5 mm well

AA 2436 8.5 mm trephine & 9 mm well



DSEK

Glider

all regions of the outer corneal surface can be gently and smoothly "Iroed" to diminish and / or eliminate donor disk wrinkles

AA 2500



DSEK Stromal Scrubber

Easy to use and effectively roughens the inner corneal stroma within the area of descemetorhexis circle

AA 2505



DSEK

Descemet's Stripper facilitates easy removal of DM as a single disk

AA 2510



DSEK

Reverse sinskey hook
size 0.2 mm dia, 0.7 mm length
AA 2515 / AAT 2515



Elevator

for ICSR implantation
opens a small packet in
intended direction
of the tunnel straight
size 0.15 mm dia, 0.7 mm length
AA 2516 / AAT 2516



Suarez Spreader

Widening the small packets in both
directions in a proper depth.
straight, size 0.25 mm
AA 2517 / AAT 2517



Bicalto Guide

Lift the cornea to insert the tunnel
maker beneath the guide.
blunt tip, angled
size 5.5 mm length, 0.65 mm dia.
AA 2518 / AAT 2518



Ring Pusher

Suitable for ICSR surgery
size 3.0 mm length, 0.4 mm dia.
AA 2519 / AAT 2519



DSEK

Marker
for marking on
recipient cornea
size 3.5 mm height, 12 mm dia.
AA 2520



DSEK

Corneal dissector
double-ended
size 0.8 mm width, 14 mm length &
1.6 mm width, 11 mm length
AA 2525 / AAT 2525



DSEK

Donor lamella shovel
it helps to prevent the folded donor lamella from sliding of during insertion

AA 2530 / AAT 2530



DMEK Rake

Blunt T-Shaped rake to help easily pull the descemet's membrane away from the stroma.

AA 2535 / AAT 2535



DMEK Large Crystal Spatula

This spatula has a smooth, rounded, olive tip extremity which is specially designed for use on the donor. Descemet's membrane within the recipient anterior chamber. It facilitates unrolling of the donor DM.

AA 2540 / AAT 2540



DMEK Small Crystal Spatula

Overall length: 115 mm
angle to tip length: 10 mm
tip diameter: 0.3 mm

AA 2545 / AAT 2545



Dexatome DMEK/DSAEK Spatula

Single instrument allows for both descemetorhexis and descemet's membrane detachment and subsequent removal. unique multi-curve design facilitates complete scoring of descemet's membrane 360° without exiting the anterior chamber.

AA 2550 / AAT 2550



DALK

Corneal dissector
12 mm long flattened vaulted spatula with beveled tip

AA 2555 / AAT 2555



Rosenwasser DALK

Trisector
triangular spatula with
chisel shaped tip, angled 45 degree at
10mm from bend to tip, size 0.2mm

AA 2560 / AAT 2560



Bonfadini DALK Spatula

1 mm wide, 8 mm long,
flattened spatula with
central groove for
bisecting stroma

AA 2565 / AAT 2565



Behler

LASIK enhancement hook

AA 2600 / AAT 2600



Seibel

LASIK flap lifter
& spatula
double-ended

AA 2605 / AAT 2605



Hardten

LASIK flap lifter
& spatula
double-ended

AA 2610 / AAT 2610



LASIK Flap

Protector
& spatula

AA 2615 / AAT 2615



LASIK Flap Protector Blades

Angled 45° for retracting and
protecting superiorly hinged
corneal flaps.

AA 2620 / AAT 2620



LASIK Flap Protector Blades

Angled 15° for retracting and protecting superiorly hinged corneal flaps

AA 2625 / AAT 2625



LASIK Spatula

Dual 12 mm long 0.25 mm diameter arms

AA 2630 / AAT 2630



Zirm

LASIK cornea surface cleaner

AA 2635 / AAT 2635



LASIK Flap Edge

Dissector for LASIK enhancements

AA 2640 / AAT 2640



LASIK Flap Manipulator

Delicate olive tip

AA 2645 / AAT 2645



Thorlakson

LASIK flap lifter
combines a modified sinskey hook and a bi-convex spatula with beveled notches

AA 2650 / AAT 2650



Membrane Spatula

1.5 mm angled, 20 G

AA 2700 / AAT 2700



Membrane Spatula
2.0 mm angled, 20 G
AA 2705 / AAT 2705



Membrane Spatula
2.5 mm angled, 20 G
AA 2710 / AAT 2710



Membrane Spatula
5.0 mm angled, 20 G
AA 2715 / AAT 2715



Ogura PVD Spatula
AA 2716 / AAT 2716 23 G



Membrane Spatula
0.5 mm curved, short rakes,
round edges, 20 G
AA 2720 / AAT 2720



Membrane Spatula
1.0 mm angled, short rakes, 20 G
AA 2725 / AAT 2725



Membrane Spatula
1.0 mm angled, long rakes, 20 G
AA 2730 / AAT 2730



Membrane Spatula Knife

5.0 mm angled,
all edges sharp, 20 G
AA 2735 / AAT 2735



Membrane Spatula

With pointed tip,
5.0 mm angled, 20 G
AA 2740 / AAT 2740



Membrane Spatula

Subretinal pic, flat,
4.0 mm angled
0.3X0.15 mm
AA 2745 / AAT 2745



Delicate Membrane Pick

AA 2746 / AAT 2746 25 G
AA 2747 / AAT 2747 27 G



Membrane Spatula

Subretinal pic, flat,
4.0 mm angled
0.3X0.2 mm
AA 2750 / AAT 2750



Membrane Spatula

2.0 and 4.0 mm angled, 20 G
AA 2755 / AAT 2755



Membrane Spatula
Rough, angled 20 G
AA 2760 / AAT 2760



Lucke Membrane Spatula
Round, curve, 20 G
AA 2765 / AAT 2765



Membrane Peeler
1.0 mm angled,
24 G / 0.6 mm
AA 2770 / AAT 2770



Membrane Peeler
1.0 mm angled,
20 G / 0.9 mm
AA 2775 / AAT 2775



Membrane Peeler
Blunt, with peeling edges, 20 G
AA 2780 / AAT 2780



Membrane Peeler
Rough, angled, 20 G / 0.9 mm for MIS
AA 2785 / AAT 2785



Morris-Kroll Membrane Peeler

Membrane peeler
1.5 mm angled,
20 G / 0.9 mm
AA 2790 / AAT 2790



BRVO Knife

Is designed for performing a lateral CRVO incision
AA 2791 / AAT 2791 20 G
AA 2792 / AAT 2792 23 G



LRI Slit Lamp Gravity Marker

Pre-op reference marker designed for limbal relaxing incisions and Toric IOL implantation to mark precision horizontal axis at the slit lamp at 3 and 9 o' clock
AAT 2800



Whitehouse Gravity Axis Marker II

Pre-op reference marker modified whitehouse gravity marker with reduced diameters straight
AAT 2805



Toric IOL Combo Marker

Pre-op marker to mark the axis while the patient is in sitting position at the slit lamp reduces cyclotorsion effect in supine position.
AAT 2815



LRI Marker

Intra-op LRI/Toric marker automatically creates marks for 6 & 8 mm chord length of limbal relaxing incision.

AAT 2820



LRI Marker

Intra-op LRI/Toric marker automatically creates marks at 40-60-80 degrees of limbal relaxing incision.

AAT 2825



Appa - Lane Pro-Op Toric Reference Marker

With bubble level intra-op LRI/Toric marker automatically creates marks at 40-60-80 degrees of limbal relaxing incision for both eyes

AAT 2830



Toric Marker With Rotator AAT 2831



LRI Axis Marker

Pre-op reference marker designed for limbal relaxing incision to mark precision horizontal axis at the slit lamp

AAT 2840



Intravitreal Injection Guide

AAT 2845 5 mm

AAT 2846 8 mm



Appa-Lane Pre Op Toric Reference Marker

Marking pattern is located on both sides for making the left & right eye temporarily marking plates are curved to conform to the curvature of the eye for more even and clear marks

marks at 3 and 9 O' clock

AAT 2860



Yeoh Thin Toric Gauge

Marking are show at every 5° with 4 slots at 0°, 90°, 180° and 270°. Slots at 0° and 180° are at the inner ring and slots at 90° and 270° are at the outer ring. The surgeon can insert a marking pen tip in the slot for marking.

AAT 2865



Graether Degree Gauge

Four elevated extension on bottom at 0°, 90°, 180°, 270° which can be used as stabilizers or for putting clean intra-op marking on the eye. Can also potentially be used as a pre-op marker. Degree marking are 10° apart

AAT 2870



Appa Two Blades Axis Marker

Single side open view. Marking plates are curved to conform to the curvature of the eye for more even and clear marks.

Marks at 3, 6, and 9 O' clock

AAT 2875



Agarwal Glued IOL Marker

Marks exactly 180° apart, for making the square scleral flaps size 3.0 mm wide

AAT 2890





Colibri Forceps

Hoskin Forceps

Corneal Forceps

Suturing Forceps

Fixation & Superior Rectus Forceps

Conjunctiva Forceps

Muscle Forceps

Chalazion Forceps

Foldable IOL Forceps & Lens Cutter

Tying Forceps

Capsulorhexis Forceps

Jewelers Forceps

Pre Choppers

Artery Forceps

Vitreo Retinal Forceps



VARIOUS TYPES OF FORCEPS TIPS

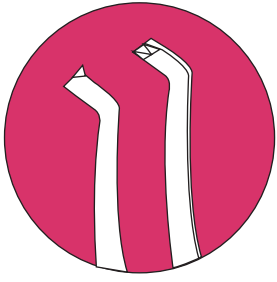

1x2 Colibri style

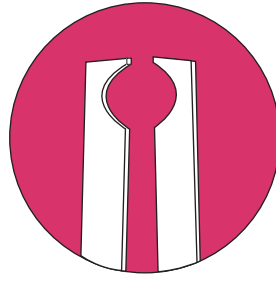

Pierse hoskin tip

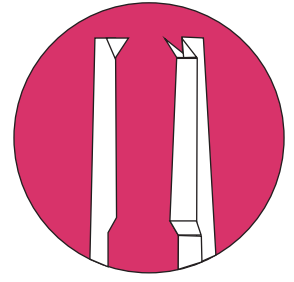

1x2 Corneal forceps

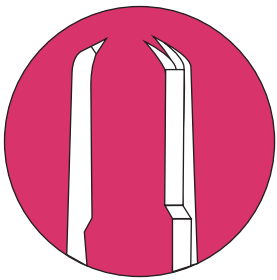

1x2 Suturing Forceps
(Castroviejo Style)

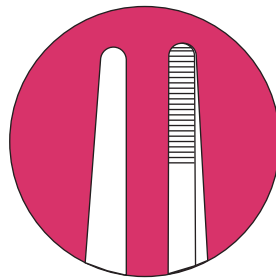

Horizontal

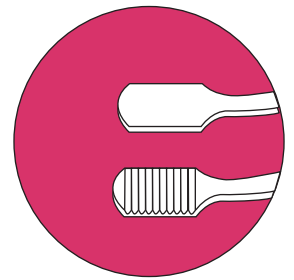

Lens Holding Forceps

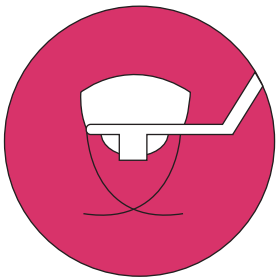

Lens Folder

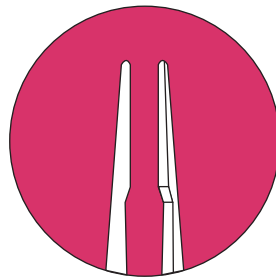

Tying Forceps

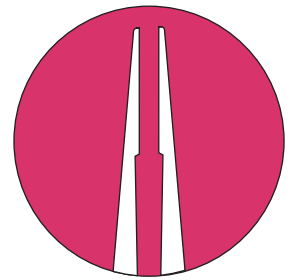

McPherson Angled

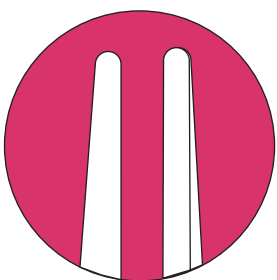

Jewelers Type
(Plain Type Tip)

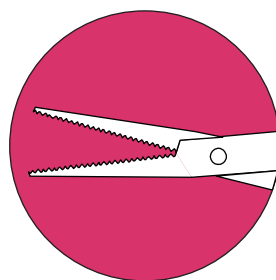

Artery Forceps

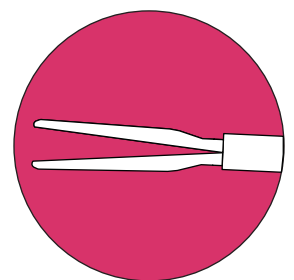

Vitreous Retinal

Botvin

Iris forceps
serrated tip
AA 3005 / AAT 3005
1x2 teeth
AA 3007 / AAT 3007



Gill

Iris forceps
curved criss-cross serrated tips
AA 3010 / AAT 3010
1x2 teeth
AA 3012 / AAT 3012



Swiss Model

Iris forceps
curved, very delicate
1 x 2 teeth
AA 3015 / AAT 3015



On Request

Iris Forceps

Very delicate, 0.4 mm teeth
with lock
AA 3016 / AAT 3016



Hess

Iris forceps
swiss model
1x2 teeth
AA 3020 / AAT 3020



Hess

Iris Forceps
standard model
1x2 teeth
AA 3025 / AAT 3025



Barraquer Colibri

Forceps, very delicate
1 x 2 teeth, 0.12 mm
with tying platform

AA 3030 / AAT 3030

without tying platform

AA 3031 / AAT 3031



Colibri

Forceps
0.4 mm, 1 x 2 teeth
with tying platform

AA 3035 / AAT 3035



Gill-Colibri

Forceps
very fine, pointed tips

AA 3040 / AAT 3040



Harms-Colibri

Suturing forceps
very delicate
1 x 2 teeth, 0.12 mm
with tying platform

AA 3045 / AAT 3045



Birk

Colibri forceps
0.12 mm, 1 x 2 teeth
with 5 mm tying platform and
2.0 mm angled tips
Round, knurled, handle

AA 3050 / AAT 3050



On Request

Polack

Double corneal forceps
for corneal suturing
very delicate, 1 x 2 teeth,
0.12 mm

AA 3055 flat handle

AA 3056 round handle



On Request

Nordan

Colibri forceps
0.12 mm 1x2 teeth with 5 mm
tying platforms and
2.0 mm angled tips
Round handle

AA 3057 / AAT 3057



Pierse

Corneal forceps
0.1 mm 1X1 pierse type teeth
straight

AA 3060 / AAT 3060



Pierse Type

Micro forceps
straight, long handle
1.5mm dia. drill

AA 3065 / AAT 3065 0.25 mm tip

AA 3070 / AAT 3070 0.35 mm tip

AA 3075 / AAT 3075 0.50 mm tip



Pierse Type

Micro forceps, curved
0.35 mm dia. drill

AA 3080 / AAT 3080 0.15 mm tip

AA 3085 / AAT 3085 0.2 mm tip



Pierse Type

Micro forceps
straight skeleton fine
0.35 mm dia. drill

AA 3090 / AAT 3090 0.15 mm tip

AA 3095 / AAT 3095 0.20 mm tip

0.8 mm dia. drill

AA 3100 / AAT 3100 0.35 mm tip



Pierse Type

Fine colibri beaked forceps

0.25 mm dia. drill

AA 3105 / AAT 3105 0.20 mm tip

AA 3110 / AAT 3110 0.25 mm tip

AA 3115 / AAT 3115 0.30 mm tip
with tying platform

AA 3120 / AAT 3120 0.30 mm tip



Castroviejo

Colibri forceps

very delicate,

1 x 2 teeth, 0.12 mm

AA 3125 / AAT 3125



Castroviejo

Colibri forceps

very delicate, 1 x 2 teeth

0.12 mm with tying platform

AA 3130 / AAT 3130



Tennant - Maumenee

Colibri forceps

with tying platform,

1 x 2 teeth, 0.12 mm

AA 3135 / AAT 3135

with suture cutter

AA 3137 / AAT 3137

On Request



Anis

Corneal forceps

with tying platform,

1 x 2 teeth, 0.12 mm

AA 3140 / AAT 3140

with suture cutter

AA 3142 / AAT 3142

On Request



Pierse type forceps

Lims type

21 0.5 mm tip

AA 3144 / AAT 3144



Lims

Corneoscleral forceps
with tying platform
1 x 2 teeth 0.12 mm
AA 3145 / AAT 3145



On Request

Lims

Suturing forceps
with tying platform
1 x 2 teeth, 0.12 mm
AA 3146 / AAT 3146



McPherson

Corneal forceps
1 x 2 teeth
0.4 mm with tying platform
AA 3150 / AAT 3150 straight
AA 3155 / AAT 3155 angled



Kelman - McPherson

Corneal forceps
7.5 mm long angled jaws,
1 x 2 teeth, 0.3 mm
AA 3160 / AAT 3160



Hoffer - McPherson

Corneal forceps
very delicate
11 mm long angled jaws
1 x 2 teeth, 0.12 mm
AA 3165 / AAT 3165



Bonn

Corneal forceps
with tying platform
1 x 2 teeth, 0.12 mm
AA 3170 / AAT 3170 long model
AA 3175 / AAT 3175 short model
AA 3176 / AAT 3176 short model curved



Castroviejo

Suturing forceps

1 x 2 teeth, with tying platform

AA 3180 / AAT 3180 0.12 mm

AA 3185 / AAT 3185 0.30 mm

AA 3190 / AAT 3190 0.50 mm

AA 3191 0.50 mm with lock

AA 3195 / AAT 3195 0.90 mm

AA 3200 1.50 mm



Castroviejo

Suturing forceps

1 x 2 teeth, with tying platform

0.3 mm, 5 mm angled

AA 3205 / AAT 3205



Castroviejo

Suturing forceps

1 x 2 teeth, with tying platform

0.5 mm, 7.5 mm angled

AA 3220 / AAT 3220



Bishop-Harmon

Tissue forceps

1 x 2 teeth

extra delicate 0.4 mm

AA 3250 / AAT 3250

delicate 0.8 mm

AA 3255 / AAT 3255



Bishop-Harmon

Dressing forceps

criss - cross serrated tips

AA 3260 / AAT 3260



Iris

Forceps

1 x 2 teeth, 0.4 mm teeth

AA 3265 / AAT 3265 curved



Kirby

Iris forceps
1 x 2 teeth

AA 3270 / AAT 3270 curved



St.Martin

Suturing forceps
1 x 2 teeth
size 0.45 mm

AA 3275 / AAT 3275



Snider-Castroviejo

Suturing forceps
1 x 2 teeth
0.12 mm with tying platform

AA 3280 / AAT 3280



Fixation

Forceps
1 x 2 teeth

AA 3300 / AAT 3300



Adson

Fixation forceps
1 x 2 teeth, standard

AA 3301 / AAT 3301



Elschnig

Fixation forceps
1 x 2 teeth, straight

AA 3304 / AAT 3304

1 x 2 teeth, angled

AA 3305 / AAT 3305



Fixation

Forceps
2 x 3 teeth, angular

AA 3310

2 x 3 teeth, straight

AA 3312



Graefe

Fixation forceps
4.5 mm wide jaws

AA 3315 with catch

AA 3317 without catch



On Request

Green

Fixation forceps
multiple teeth
AA 3320 5 mm wide jaws
AA 3325 10 mm wide jaws



Lester

Fixation forceps
straight
AA 3330 1 x 2 teeth
AA 3335 2 x 3 teeth



Dastoor

Superior rectus forceps
1 x 2 teeth
AA 3340 / AAT 3340



Moody

Fixation forceps
1 x 2 teeth, 0.5 mm
AA 3350 left, without lock
AA 3351 right, without lock
AA 3352 left, with lock
AA 3353 right, with lock



On Request

Bores

Fixation forceps
3 mm spread, each 0.12 mm,
1 x 2 teeth
AA 3400 straight
AA 3405 curved



On Request

Kramer

Corneal fixation forceps
with lock "U" shaped 13 mm spread,
each 0.12 mm, 1 x 2 teeth
straight with catch
AA 3410



Neyses-Wallace Fixation Forceps

For ICSR surgery,
two point fixation
tips seperated by 13.0 mm
straight

AA 3411

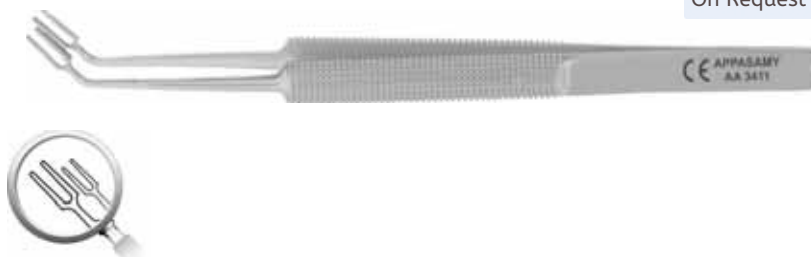

On Request

Kramer

Corneal fixation forceps
with lock "U" Shaped 13 mm spread,
each 0.12 mm, 1 x 2 teeth
curved with catch

AA 3415



On Request

Eye Dressing

Forceps
serrated delicate

AA 3450 / AAT 3450 straight

AA 3455 / AAT 3455 curved



Adson

Dressing forceps

AA 3451 / AAT 3451



Wills Hospital

Utility forceps
criss - cross serrated tips

AA 3460 / AAT 3460



Bonaccolto

Utility forceps
longitudinally serrated jaws
with cross serrations at tips
1.2 mm wide

AA 3465 / AAT 3465

1.7 mm wide

AA 3467 / AAT 3467



Moorfield

Conjunctival suture forceps
horizontally serrated jaws
with groove

AA 3470 / AAT 3470



Jayle

Corneal suture &
fixation forceps

1 x 2 teeth with tying platform

AA 3475 / AAT 3475



Barraquer

Cilia forceps
lightly angled, smooth jaws

AA 3480 / AAT 3480



Beer

Cilia forceps

AA 3485 / AAT 3485



Gradle

Cilia forceps
smooth, squared off
positive gripping jaws

AA 3490

On Request



Elschnig

Capsule forceps

AA 3500



Arruga

Capsule forceps

AA 3505



Arruga

Capsule forceps
new curve
AA 3510



On Request

Hess

Extra capsular forceps
AA 3515 simple curve
AA 3517 double curve



On Request

Prince

Advancement forceps
AA 3525 left
AA 3530 right



Jameson

Muscle forceps
with slide lock
AA 3535 left, child 4 teeth
AA 3540 right, child 4 teeth
AA 3545 left, child 6 teeth
AA 3550 right, child 6 teeth



Worth

Advancement forceps
with slide lock
longitudinally grooved jaws
AA 3555 left
AA 3560 right

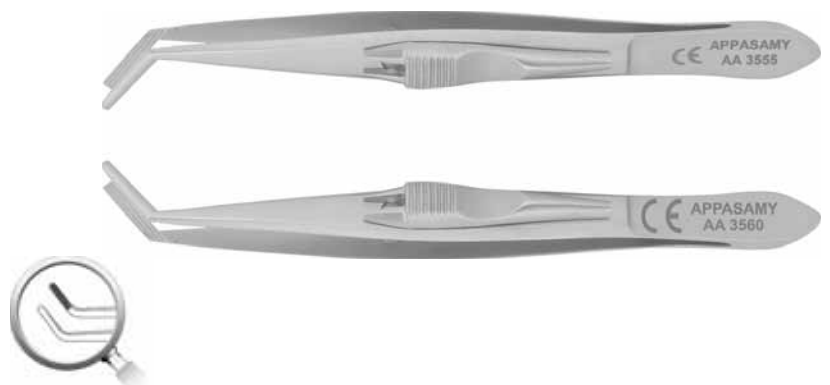

Berke

Ptosis forceps
with slide lock
longitudinally grooved jaws
AA 3565 20 mm
AA 3570 27 mm



Snellen

Entropium forceps
AA 3600 left, small
AA 3605 right, small
AA 3607 left, adult
AA 3609 right, adult



Erhardt

Lid forceps
AA 3610



Trachoma Forceps

AA 3611 small, 26 mm width
AA 3612 medium, 28 mm width
AA 3613 large, 30 mm width
AA 3614 extra large, 32 mm width



Ayer

Chalazion forceps
size 9 mm inner plate & 12 mm outer ring
AA 3615 / AAT 3615



Lambert

Chalazion forceps
round, 8 mm diameter
AA 3620 / AAT 3620



Desmarres

Chalazion forceps
oval shape

- AA 3625 / AAT 3625** 13 mm dia.
- AA 3626 / AAT 3626** 20 mm dia.
- AA 3627 / AAT 3627** 26 mm dia.
- AA 3628 / AAT 3628** 31 mm dia.



Hunt

Chalazion forceps
round, 12 mm diameter

AA 3630 / AAT 3630



Battle Eyelid Compression Forceps

Broad, smoothly polished tips;
intended for expressing meibum
from inflamed or occluded meibomian
glands

AA 3640



Tears Meibum Expressor Forceps

Broad, smoothly polished tips;
intended for expressing meibum from
inflamed or occluded meibomian
glands

AA 3641 / AAT 3641



Arita Meibomian Gland Compressor

Oval shaped, polished paddles used
for compression of meibomian glands

AA 3642 / AAT 3642



Meibomian Expressor Paddle

Double ended

AA 3643 / AAT 3643



Anis

Lens holding forceps
extra delicate
9 mm long smooth jaws
45° angle

AA 3650 / AAT 3650



Blaydes

Lens holding forceps
very delicate narrow
smooth jaws, 45° angle
AA 3655 / AAT 3655



Clayman

Lens holding forceps
delicate with curved shanks
AA 3660 / AAT 3660



Dodick

Lens holding forceps
angled smooth jaws,
angled forward for comfortable
hand position
AA 3665 / AAT 3665 angled left
AA 3667 / AAT 3667 angled right



Kellan

Endocapsular IOL Insertion forceps
Diameter of the tip
is 0.15 mm for implantation of
the superior haptic of IOL
AA 3670 / AAT 3670



Forceps for ICSR Implant

Used for ICSR implantation
1x1 teeth 0.2 mm
0.3 mm groove
AA 3671 / AAT 3671



Kraff

Lens holding forceps
delicate, curved jaws to grasp
PC lens optic edge
AA 3675 / AAT 3675
flat handle
AA 3677 / AAT 3677
round handle



Kratz

Lens holding forceps
with smooth curved jaws
AA 3680 / AAT 3680



Shepard

Lens holding forceps
serrated jaws
AA 3685 with lock



Shepard

Lens holding forceps
Gently curved, duckbill shaped jaws
AA 3690 / AAT 3690



Lieberman

Lens forceps
T-Bar on upper and
lower jaws for
excellent stability in holding
biconvex IOL
AA 3695 with lock
AA 3697 without lock



Sinskey

Lens holding forceps
for Iris claw lens
with delicate T-shaped lower jaw
ideal for biconvex
ridged or plano lenses
AA 3700 45° angle
AA 3702 with lock
AA 3704 15° angle

On Request



Simcoe II

Lens implant forceps
one short blunt
and long sharp tip
AA 3705 / AAT 3705



On Request

Lieberman

Micro-ring lens forceps
1.2 mm dia. ring ideal for
implanting IOLs
AA 3710



Trocar Loading Forceps
AA 3712 / AAT 3712



Faulkner

Lens holding forceps
with smooth polished round jaws
pick up foldable IOL
from case without marking
or damage the lens
AA 3715 / AAT 3715



On Request

Utrata

Foldable lens retriever
angled with teeth
AA 3716 / AAT 3716



Chu

Foldable lens cutter
for soft intraocular lenses
AA 3718



Chu

Foldable lens cutter
groove tip 11 mm
AA 3718A



Foldable Lens Cutter

To cut silicone or acrylic IOL
in case of complications
AA 3719



Appasamy Lens Cutter

To cut silicone IOL
in case of complications
by sideport incision
AA 3719A



Foldable Lens Removing Forceps

To remove silicone or acrylic IOL
in case of complications
AA 3720



On Request

DSEK

Unique forceps design allows for distal tip contact first preventing tissue compression and protects donor corneal endothelium. Ease in surgeon insertion of "taco-fold" donor cornea with the 120-Degrees vertically oriented forceps handle and horizontally oriented carrier platforms.

AA 3721



On Request

Foldable Lens

Cutting forceps
round handle, serrated blade tip
AA 3722



On Request

Faulkner

Lens inserting forceps
for folding and inserting
soft IOLs through small incision
AA 3725



On Request

Faulkner II

Lens inserting forceps for foldable IOL

AA 3730



Rosenwasser

Donor lamella inserting forceps thin vaulted 12 mm long shanks precalibrated heel stops to prevent tips from closing

AA 3731 / AAT 3731



Appasamy

lens injector for 'C' cartridge Incision size 2.2 mm

AA 3732 / AAT 3732



Appasamy

lens injector for 'D' cartridge Incision size 2.8 mm

AA 3733 / AAT 3733



On Request

Appasamy

Universal lens injector

AA 3737 / AAT 3737



CTR Injector

For Capsule Tension Ring

AAT 3738



On Request

Lens Folder and Pusher

AAT 3739



On Request

Kellan

Foldable IOL forceps designed to contour the silicone IOL rather than fold the IOL

AA 3740



Appasamy

Lens folding forceps
cross action
Ideal for silicone & acrylic
foldable lenses. Consistently
folds the IOL evenly and equally
while preventing the lens from
reverse folding

AA 3741 / AAT 3741

On Request



Appasamy

Lens folding forceps
direct action
for foldable lens
evenly folds acrylic and
silicone lenses of
5.5 mm or 6 mm diameter

AA 3742 / AAT 3742

On Request



Appasamy

Lens inserting forceps
for foldable Lens
30° angled tip
with 4.5 mm tip opening

AA 3743 / AAT 3743

On Request



Appasamy

Lens inserting forceps
for foldable lens
flat body (cross action)

AA 3744 / AAT 3744

On Request



Appasamy

Universal lens folding
forceps (round stock)

AA 3745 / AAT 3745

On Request



Appasamy

Lens implantation forceps
(direct action)

AA 3746 / AAT 3746

On Request



Appasamy

Universal lens folding forceps
flat stock, ideal for silicone and acrylic foldable IOLs, box model jaws facilitates the folding of the lens precisely for transfer to the inserter

AA 3747 / AAT 3747



On Request

Appasamy

Universal lens inserting forceps
ideal for silicone and acrylic foldable IOLs, for box model, smooth curved jaws with rounded edges grip the lens gently and firmly

AA 3748 / AAT 3748



On Request

Donnenfeld

Micro soft IOL cutter
4 mm long blades
micro notches in blades for traction

AA 3749 / AAT 3749



On Request

Donnenfeld

Micro IOL holding forceps
21 G blunt, paddle-shaped tips
central hole for traction and visibility for grasping a soft IOL during cutting and explanation.

AA 3749A / AAT 3749A



On Request

Jaffe

Tying forceps
smooth jaws with 5 mm long platform, ideal for 8-0 to 11-0 sutures

AA 3750 / AAT 3750 straight

AA 3755 / AAT 3755 curved



On Request

Tennant

Tying forceps
with guide pin, extra delicate
smooth jaws, with 5 mm long
platform for 9-0 to 11-0 sutures
AA 3760 / AAT 3760 straight
AA 3765 / AAT 3765 curved



Harms

Tying forceps
smooth jaws, with 0.5 mm tip width
5 mm long platform
ideal for 7-0 to 9-0 sutures
AA 3770 / AAT 3770 straight
AA 3775 / AAT 3775 curved



Jayle

Tying forceps
smooth jaws, with, 0.8 mm tip width
5 mm long platform
ideal for 7-0 to 9-0 sutures
AA 3780 / AAT 3780 straight
AA 3781 / AAT 3781 curved



McPherson

Tying forceps
small handle smooth jaws,
5 mm long platform
ideal for 8-0 to 11-0 sutures
AA 3785 / AAT 3785 straight
AA 3786 / AAT 3786 curved



McPherson

Tying Forceps
smooth jaws, 5 mm long platform
ideal for 8-0 to 11-0 sutures
straight long handle
AA 3790 / AAT 3790



McPherson

Tying forceps
smooth jaws
5 mm long platform, 5 mm angled
ideal for implanting IOL &
8-0 to 11-0 sutures
AA 3793 / AAT 3793 short handle
AA 3795 / AAT 3795 long handle



Kelman-McPherson

IOL forceps
smooth jaws, 5 mm platform,
7.5 mm angled,
ideal for implanting IOL
AA 3798 / AAT 3798 short handle
AA 3800 / AAT 3800 long handle



McPherson

IOL forceps
smooth jaws, 11 mm long
platform angled,
ideal for implanting IOLs
AA 3805 / AAT 3805



Sinskey

Tying forceps
very delicate smooth jaws
ideal for 8-0 to 11-0 sutures
AA 3810 straight
AA 3815 curved



Kraff

Capsule tag forceps
11 mm long jaws with
1.5 mm long smooth
platform at tips.
recessed inside jaws surfaces
prevent inadvertent Iris pickup
AA 3850 / AAT 3850



Utrata

Capsulorhexis forceps
very delicate grasping tips and
extremely thin 11 mm
long straight shanks
AA 3855 / AAT 3855
AA 3855A marking 2.0
AA 3855B marking 2.5
AA 3855C marking 2.75
AA 3855D marking 3.0



On Request

Inamura

Capsulorhexis forceps
very delicate grasping
tips and extremely thin
11 mm long
AA 3856 / AAT 3856 curved shanks
AA 3856A / AAT 3856A straight shanks

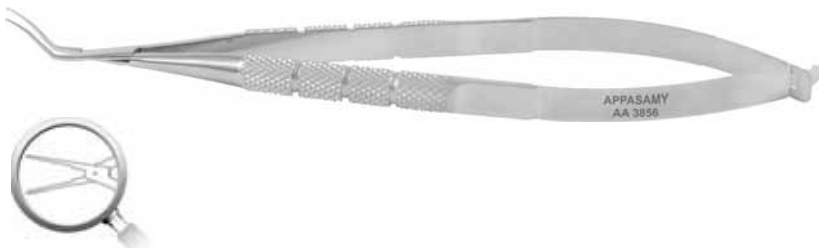

On Request

Akahoshi

Capsulorhexis forceps
cross action forceps, cross action
mechanism reduces loss of
visco elastic material through the
incision through side port incision
anterior chamber can be better
controlled. Capsule can be punctured
easily and grasp it firmly.
AA 3860



Utrata

Capsulorhexis forceps
tip length 11 mm 45° Ang.
Iris stop platform, 8.5 tip
Round handle
straight shanks
AA 3861 / AAT 3861
curved shanks
AA 3862 / AAT 3862



Pierce

Capsulorhexis forceps
tip length 11 mm 45° angled shafts
Round handle
AA 3863 / AAT 3863



Giannetti

MICS capsulorhexis forceps
ultra delicate shanks and tips
maximum jaw opening 2 mm.
for performing capsulorhexis
through a 1.5 mm incision.
AA 3864



Nevyas

Capsulorhexis forceps
extremely thin 11 mm long shanks
cystotome shaped tips for
penetrating and grasping
anterior capsule
AA 3865 / AAT 3865



Capsulorhexis

Forceps
straight round handle
with 2 mm marking
goes through a 1.8 mm incision.
AA 3866 / AAT 3866



Utrata Capsulorhexis

Forceps
straight round handle
goes through a 1.8 mm incision.
AA 3868 / AAT 3868 straight
AA 3869 / AAT 3869 curved



Masket

Capsulorhexis forceps
very delicate grasping
tips and extremely thin
11 mm long curved shanks

AA 3870 / AAT 3870

AA 3870A marking 2.0 mm

AA 3870B marking 2.50 mm

AA 3870C marking 2.70 mm

AA 3870D marking 3.0 mm



Kreshner

Micro incision
capsulorhexis forceps, curved

AA 3871 / AAT 3871 20 G

AA 3871A / AAT 3871A 21 G

AA 3872 / AAT 3872 23 G

AA 3873 / AAT 3873 25 G



Jaffe

Capsulorhexis forceps
very delicate, round grasping tips
extremely thin 11 mm long shanks

AA 3875 / AAT 3875



Buratto

LASIK flap forceps
serrated & abrasive blasted
inner surface

AA 3876 / AAT 3876



Perone

LASIK forceps
abrasive blasted
inner surface

AA 3877 / AAT 3877



Multi Purpose

LASIK forceps
smooth, polished
inner surface

AA 3878 / AAT 3878



Jewelers

Forceps
standard

AA 3885 / AAT 3885 # 1



Jewelers

Forceps
delicate short

AA 3887 / AAT 3887 # 3c



Jewelers

Forceps
delicate

AA 3890 / AAT 3890 #3



Jewelers

Forceps
delicate

AA 3892 / AAT 3892 #4



Jewelers

Forceps
extra delicate

AA 3894 / AAT 3894 #5



Jewelers

Forceps
delicate angled for removal
of 9-0 and 10-0 sutures

AA 3896 / AAT 3896 #5A



Jewelers

Forceps
curved

AA 3898 / AAT 3898 #7



Osher

Iris forceps
very fine textured jaws

AA 3900 / AAT 3900



Alabama

Utility forceps
straight shaft with 15 mm long
`V' groove tying platform
AA 3901 / AAT 3901



Suture

Removal forceps
very fine pointed tips
AA 3902 / AAT 3902



H.K.Punch

For nucleus cutting
size 4.5 mm length, 15 mm angled length
AA 3903

On Request



Foreign Body

Forceps
straight, sharp pointed tips
AA 3904 / AAT 3904



Akahoshi

Nucleus fragment
removal forceps
suitable for removing
fragments through a
small incision
AA 3905

On Request



Dodick

Nucleus cracking forceps
the splitter tip is 2 mm in length
and 1 mm in height with cross
action and cross serrated, paddle
shaped jaws to divide the
nucleus into small segments
during phaco emulsification
AA 3906 / AAT 3906



Akahoshi

Nucleus splitter forceps
can be used to divide the nucleus
after grooving for divide and conquer
technique
size 9.0 mm tip length, 4.0 mm opening width
AA 3907

On Request



Kansas

Nucleus fragment removal forceps
serrated jaws for extracting lens
nucleus fragments for manual
small incision surgery
size 9.0 mm angled
AA 3908 / AAT 3908 straight
AA 3909 / AAT 3909 curved



Akahoshi

Phaco pre chopper
smooth pointed tips to pierce the
nucleus and crack for phaco
open to 3 mm straight shaft,
cross action, round handle
AA 3910 / AAT 3910 pointed tips



Akahoshi

Smooth flattened pointed tips
open to 3 mm
round handle for cracking,
dividing and rotating the
nucleus without sculpting
AA 3911 / AAT 3911 straight



Akahoshi Phaco Pre Chopper

Smooth flattened pointed tips
open to 3 mm
round handle for cracking,
dividing and rotating the
nucleus without sculpting
AA 3912 / AAT 3912 angled



Akahoshi Combo Pre Chopper

For cracking, dividing rotating
the nucleus without sculpting
AA 3913 / AAT 3913 straight



Akahoshi Phaco Pre Chopper

With flattened pointed tips
AA 3914 / AAT 3914 angled,
gently curved



Bores

Incision spreading forceps with 3 mm jaws controlled opening 0.5 mm square jaws with micro serrations

AA 3915 / AAT 3915



Inamura Eagle Pre Chopper

Narrow tip is easy to insert to the denser nucleus. It enables division from soft to dense nucleus without the counter force. The shape of the tip makes rotation of the nucleus easier in the capsule bag.

AA 3916 / AAT 3916



Akahoshi Hybrid Pre Chopper

For Grades 1-4 Nuclei. Groove enables easy rotation of the Nuclei during prechopping. Nuclei of these grades can be easily divided using the Karate Prechop technique. Using the technique the nucleus is prechopped into 4 or more sections before introducing the phaco handpiece. Harder nuclei or nuclei with weak ciliary zonules should be prechopped very carefully, supported with a nucleus sustainer to reduce the stress on the ciliary zonules.

AA 3917 / AAT 3917



On Request

Akahoshi

Super combo prechopper 20g, able to fit through a 1.2 mm incision

AA 3918 / AAT 3918



Akahoshi

Paddle prechopper broad blade safely and effectively prechops soft nuclei of grades 1 and 2

AA 3919 / AAT 3919



Hartman

Mosquito forceps
extra delicate
3.75" (95 mm) long
AA 3920 / AAT 3920 straight
Aa 3925 / AAT 3925 curved



Allis

Tissue forceps
box joint with teeth
1x2 teeth, 95 mm
AA 3926 straight
AA 3927 curved



Halsted

Mosquito forceps
Delicate
5.25" (145 mm) long
AA 3930 / AAT 3930
straight



Halsted

Mosquito forceps
delicate
5.25" (145 mm) long
AA 3935 / AAT 3935 curved



Allis

Tissue forceps
box joint with teeth
5.25" (145 mm) long
AA 3936 straight
AA 3937 curved



Appasamy

Cheatle forceps
box joint for lifting instruments from
sterilizer overall length 200 mm
AA 3938



Backhaus

Towel clamp
AA 3940 3.5" (90 mm) long
AA 3942 5.25" (135 mm) long



Baby Jones

Towel clamp forceps
cross-action
2.25" (55 mm) long
AA 3945



Appasamy

Sponge holding forceps
box joint serrated jaws
overall length 200 mm
AA 3946



Ring Type

Needle Holder
AA 3947



Serrefine

Serrated jaws
1.5" (38 mm) long
AA 3950 straight
AA 3952 curved



Vitreous Forceps

Smooth jaws, straight
AA 3960 / AAT 3960 20 G
AA 3960A / AAT 3960A 23 G



AA - Stainless Steel, AAT - Titanium

QUALITY | SERVICE | INTEGRITY

Diamondized Gripping

Forceps straight

- AA 3961 / AAT 3961 20 G
- AA 3961A / AAT 3961A 23 G
- AA 3961B / AAT 3961B 25 G
- AA 3961C / AAT 3961C 27 G



Vitreous Forceps

AA 3962 / AAT 3962 18 G

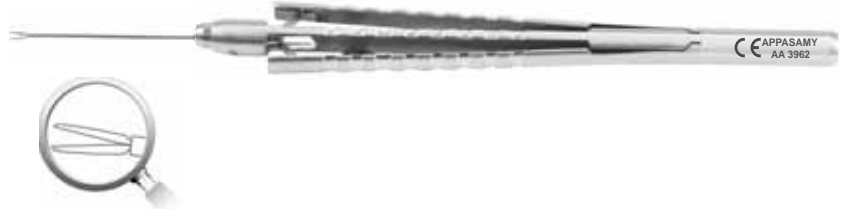

Crocodile Gripping

Forceps

- AA 3963 / AAT 3963 20 G
- AA 3963A / AAT 3963A 23 G

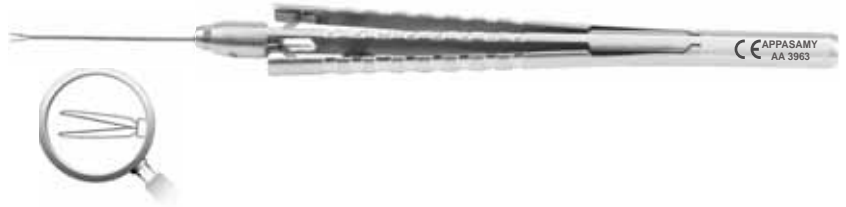

Vitreous Forceps

Serrated jaws, straight

- AA 3965 / AAT 3965 20 G
- AA 3965A / AAT 3965A 23 G



Vitreous Forceps

Smooth jaws, 1x2 teeth straight

AA 3970 / AAT 3970 20 G



End Gripping Forceps

- AA 3971 / AAT 3971 20 G
- AA 3971A / AAT 3971A 23 G



End Gripping Forceps

With micro jaws,

- AA 3972 / AAT 3972 20 G
- AA 3972A / AAT 3972A 23 G

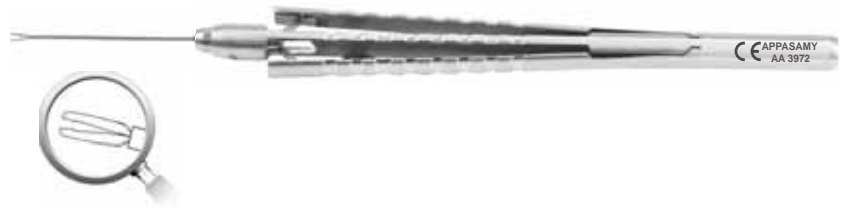

Vitreous Forceps

Smooth jaws, 0.3 mm platform, straight

AA 3975 / AAT 3975 20 G

AA 3975A / AAT 3975A 23 G



Pick Forceps

AA 3976 / AAT 3976 20 G

AA 3976A / AAT 3976A 23 G

AA 3976B / AAT 3976B 25 G



Appa Pick Forceps

AA 3977 / AAT 3977 20 G

AA 3977A / AAT 3977A 23 G



Gripping Angled Forceps

AA 3978 / AAT 3978 20 G



Sub Retinal Forceps

AA 3979 / AAT 3979 20 G



Vitreous Forceps

Smooth jaws, vertical

AA 3980 / AAT 3980 20 G

AA 3980A / AAT 3980A 23 G



Vitreous Forceps

30° Ang jaws

AA 3981 / AAT 3981 23 G

AA 3981A / AAT 3981A 25 G

AA 3981B / AAT 3981B 27 G



Asymmetrical

End gripping forceps

AA 3982 / AAT 3982 20 G

AA 3982A / AAT 3982A 23 G

AA 3982B / AAT 3982B 25 G



Tanaka

MaCulorhexis forceps

AA 3983 / AAT 3983 23 G



Kawai

ILM forceps

AA 3984 / AAT 3984 25G



Vitreous

Forceps

AA 3985 / AAT 3985 20 G



ILM Forceps

AA 3986 / AAT 3986 20 G

AA 3986A / AAT 3986A 23 G



Lens Cartridge

Loading forceps ICL

AA 3987 / AAT 3987 20 G

AA 3987A / AAT 3987A 23 G

AA 3987B / AAT 3987B 25 G

AA 3987C / AAT 3987C 27 G



Foreign Body Forceps

AA 3988 / AAT 3988 17 G



Vitreoretinal Forceps

With cup jaws

AA 3989 / AAT 3989 20 G



Iridectomy Forceps

Designed to perform capsulorhexis

through 0.8 mm side-port incision

straight 23 gauge shaft

delicate tips

with lock

compatible with squeeze handle

AA 3990 / AAT 3990



Spring Gripping Forceps

AA 3991 / AAT 3991 20 G

AA 3991A / AAT 3991A 23 G



Large Foreign Body Forceps

AA 3992 / AAT 3992 20 G



Endothelial Gripping Forceps

AA 3993 / AAT 3993 20 G



Agarwal Glued IOL Forceps

AA 3995 / AAT 3995 straight 20 G

AA 3995A / AAT 3995A straight 23 G

AA 3995B / AAT 3995B straight 25 G

AA 3996 / AAT 3996 curved 20 G

AA 3996A / AAT 3996A curved 23 G

AA 3996B / AAT 3996B curved 25 G



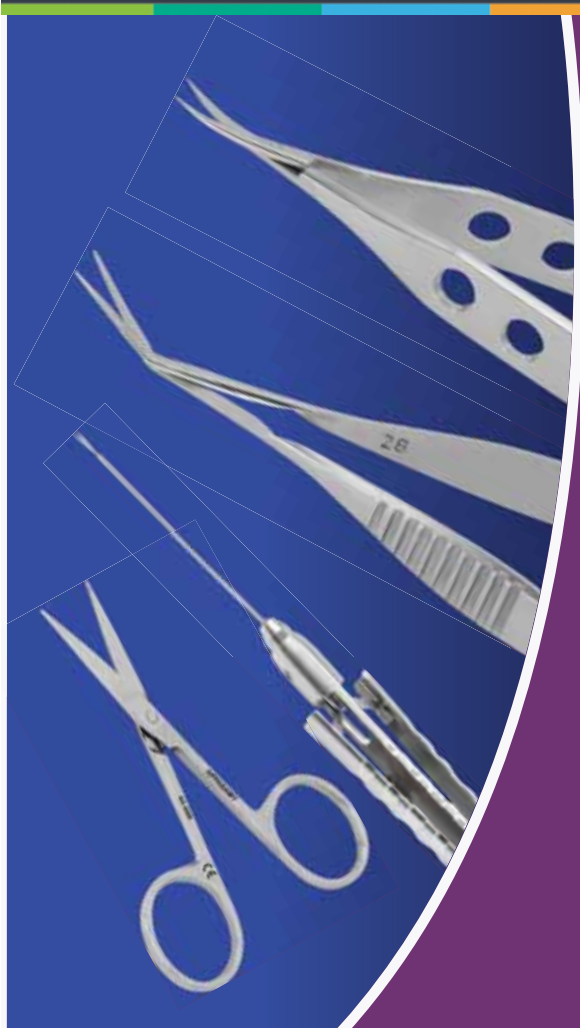

Corneoscleral Scissors

Conjunctiva Scissors

Vannas Scissors

Vitreous Scissors

Eye Scissors

Enucleation Scissors



Castroviejo

Corneoscleral scissors
small blades
blade length 9 mm
AA 4010 / AAT 4010 left



Castroviejo

Corneoscleral scissors
small blades
blade length 9 mm
AA 4015 / AAT 4015 right



Castroviejo

Corneoscleral scissors
medium blades
blade length 10 mm
AA 4020 / AAT 4020 left



Castroviejo

Corneoscleral scissors
medium blades
blade length 10 mm
AA 4025 / AAT 4025 right



Troutman-Katzin

Corneal transplant scissors
strong curve, with lock
6 mm long blades
AA 4030 left



Troutman-Katzin

Corneal transplant scissors
strong curve, with lock
6 mm long blades
AA 4035 right



Castroviejo

Corneal scissors
curved blunt tips
small blades 9 mm length
AA 4040 / AAT 4040
medium blades 11 mm length
AA 4045 / AAT 4045



Castroviejo

Corneal scissors
curved blunt tips
large blades 13 mm length
AA 4050 / AAT 4050



Castroviejo

Corneal transplant scissors
strong curve & large blades
blade length 13 mm
AA 4060 / AAT 4060



Castroviejo

Keratoplasty scissors
angled to side
blunt tips
small blades
blade length 9 mm
AA 4065 / AAT 4065



Castroviejo

Keratoplasty scissors
angled to side
blunt tips
medium blades
blade length 11 mm
AA 4070/ AAT 4070



Micro

Iris scissors
pointed tips
blade length 10 mm
AA 4095/ AAT 4095 straight
AA 4096/ AAT 4096 curved



Micro

Corneal scissors
curved, pointed tips
small blades
blade length 9 mm
AA 4100 / AAT 4100



Micro

Corneal scissors
curved, pointed tips
medium blades
blade length 11 mm
AA 4105 / AAT 4105



Micro

Corneal scissors
half curved, long blades, 12 mm
AA 4107 / AAT 4107



Micro

Iris scissors
curved, pointed tips
large blades
blade length 14 mm
AA 4110 / AAT 4110



Micro

Iris scissors
strong curved, pointed tips
small blades
blade length 12 mm
AA 4115 / AAT 4115



Barraquer

Iris scissors
blunt tips
7 mm long blades
AA 4120



De-Wecker

Iris scissors
blade length 12 mm
AA 4125 sharp-blunt
AA 4126 sharp-sharp
AA 4127 blunt-blunt



McPherson Westcott

Conjunctival scissors
curved, blunt tips
blade length 12 mm
AA 4150 / AAT 4150 small blades



Westcott

Tenotomy scissors
curved, blunt tips
blade length 16 mm
AA 4155/ AAT 4155 medium blades



Westcott

Tenotomy scissors
curved, blunt tips
blade length 23 mm
standard blades
AA 4160/ AAT 4160 left
AA 4165/ AAT 4165 right



McPherson - Westcott

Stitch scissors
very sharp pointed tips
small blades, curved
blade length 11 mm
AA 4170 / AAT 4170



Jaffe

Stitch scissors
very sharp pointed tips
medium blades, curved
blade length 13 mm
AA 4175 / AAT 4175



Westcott

Tenotomy scissors
curved, blunt tips
large blades
blade length 23 mm
AA 4180 / AAT 4180



Fine

Stitch scissors
sharp tips
medium blades, straight
blade length 14 mm
AA 4195 / AAT 4195



Vannas

Capsulotomy scissors
sharp tips
blade length 9 mm
AA 4250 / AAT 4250 straight
AA 4255 / AAT 4255 curved



Appasamy

Capsule tag scissors
15 mm long spatulated
gently curved, blunt tip blades
for cutting capsule tags and
anterior capsulotomy
blade length 12 mm
AA 4260 / AAT 4260 short handle
blade length 16 mm
AA 4265 / AAT 4265 long handle



Vannas

Capsulotomy scissors
sharp tips
forward 9 mm blades
AA 4270 / AAT 4270 angled



Vannas

Capsulotomy scissors
sharp tips
forward 11 mm blades
AA 4275 / AAT 4275 angled



Vannas

Capsulotomy scissors
sharp tips
angled to side
blade length 7.5 mm
AA 4280 / AAT 4280



Gills-Vannas

Capsulotomy scissors
extra thin long blades
sharp tips
blade length 8 mm
AA 4285 / AAT 4285 straight
blade length 8 mm
AA 4290 / AAT 4290 curved
blade length 10 mm
AA 4295 / AAT 4295 angled forward



McPherson-Vannas

Iris scissors
sharp tips
blade length 8 mm
AA 4300 / AAT 4300 curved



DALK Scissors

Blunt, 8 mm angled blades
AA 4335 / AAT 4335



Stern-Gills

Capsulotomy scissors
extra thin
10 mm long blades
AA 4350 / AAT 4350



Hoffer-Stern

Capsulotomy scissors
extra thin, 10 mm long curved
blades, convex
AA 4355 / AAT 4355



Uribe-Stern

Capsulotomy scissors
extra thin, 10 mm long curved
blades, concave
AA 4365 / AAT 4365



Koch

Endocapsular scissors
extra thin, 10 mm long delicate
curved blades
AA 4370 / AAT 4370



Vannas

Long handle scissors
extra thin, 10 mm long blades
sharp points
AA 4375 / AAT 4375



Appasamy

Intraocular scissors
squeeze handle, protective cap
17gauge to cut capsular tags
AA 4400 straight
AA 4410 curved
blade length 7 mm

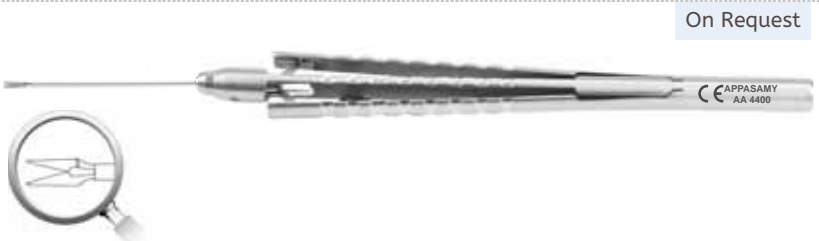

On Request

Scimeca

Lens loop amputator
for cutting poly propylene
or PMMA lens haptics in the
anterior or posterior chamber
AA 4420 left
AA 4425 right
blade length 3 mm



On Request

Vitreous

Scissors
straight jaws
blade length 5 mm
AA 4450 / AAT 4450 20 G
blade length 4 mm
AA 4450A / AAT 4450A 23 G



Vitreous

Scissors
Curved jaws
blade length 5 mm
AA 4455 / AAT 4455 20 G
blade length 4 mm
AA 4455A / AAT 4455A 23 G



Vitreous

Scissors
angled jaws 30°
blade length 3 mm
AA 4460 / AAT 4460 20 G



Vitreous

Scissors

vertical cut 60°

blade length 3 mm

AA 4470 / AAT 4470 20 G

AA 4470A / AAT 4470A 23 G



Vitreous

Scissors

vertical cut 90°

blade length 3 mm

AA 4480 / AAT 4480 20 G

AA 4480A / AAT 4480A 23 G



Iris Scissors

Delicate pointed tips

ring handle straight

AA 4500 3.5" length

AA 4501 4.0" length



Iris Scissors

Delicate pointed tips

ring handle curved

AA 4505 3.5" length

AA 4506 4.0" length



Eye Scissors

Delicate pointed tips

ring handle straight

AA 4510 4.5" length

AA 4511 5.0" length



Eye Scissors

Delicate pointed tips
ring handle, curved
AA 4515 4.5" length
AA 4516 5.0" length



Stitch Scissors

Needle points
ring handle
blade length 25 mm
AA 4520 straight
AA 4525 curved



Stevens

Tenotomy scissors
blunt tips, ring handle
blade length 25 mm
AA 4530 straight



Stevens

Tenotomy scissors
blunt tips, ring handle
blade length 25 mm
AA 4535 curved



Knapp

Strabismus scissors
blunt tips, ring handle
blade length 28 mm
AA 4550 straight
AA 4555 curved



Enucleation Scissors

Ring handle
blade length 40 mm
AA 4575 straight



Enucleation Scissors

Ring handle
blade length 40 mm
AA 4580 medium curve



Enucleation Scissors

Ring handle
blade length 40 mm
AA 4585 strong curve



Mayo Scissors

Overall length 5.5"

AA 4590 straight

AA 4595 Curved



Vertical Scissors

45° 25 G

AA 4600 / AAT 4600



Vertical Scissors

55° 20 G

AA 4605 / AAT 4605



Horizontal Scissors

45°, regular blades

AA 4610 / AAT 4610 20 G



Horizontal Scissors

45°, short blades

AA 4615 / AAT 4615 20 G



Horizontal Scissors

Sub Retinal scissors, curved

AA 4620 / AAT 4620 23 G



AA - Stainless Steel, AAT - Titanium



Superior Rectus Needle Holder

Castroviejo Needle Holder

Barraquer Needle Holder

Blade Breaker & Holder

Blades



Arruga

Needle holder

AA 5010 / AAT 5010 straight

AA 5015 / AAT 5015 curved



Kalt

Needle holder

AA 5020 / AAT 5020 straight

AA 5025 / AAT 5025 curved



Silcock

Needle holder

AA 5030 / AAT 5030



McPherson

Needle holder

very delicate jaws

AA 5040 / AAT 5040 straight, with lock

AA 5045 / AAT 5045 straight, without lock

AA 5046 / AAT 5046 (short model) straight, without lock

AA 5050 / AAT 5050 curved, with lock

AA 5055 / AAT 5055 curved, without lock

AA 5058 / AAT 5058 110mm with lock straight



Castroviejo

Needle holder

delicate jaws

ideal for 7-0 to 9-0 sutures

AA 5060 / AAT 5060 straight, with lock

AA 5065 / AAT 5065 straight, without lock

AA 5070 / AAT 5070 curved, with lock

AA 5075 / AAT 5075 curved, without lock



Castroviejo

Needle holder
standard jaws
ideal for 4-0 to 7-0 sutures

- AA 5080 / AAT 5080** straight, with lock
- AA 5085 / AAT 5085** straight, without lock
- AA 5090 / AAT 5090** curved, with lock
- AA 5095 / AAT 5095** curved, without lock



Drews

Needle holder
extra delicate jaws

- AA 5100 / AAT 5100** straight, with lock
- AA 5105 / AAT 5105** straight, without lock
- AA 5110 / AAT 5110** curved, with lock
- AA 5115 / AAT 5115** curved, without lock



Barraquer

Needle holder
short model
very delicate jaws

- AA 5120 / AAT 5120** straight, with Lock
- AA 5125 / AAT 5125** straight, without Lock
- AA 5130 / AAT 5130** curved, with Lock
- AA 5135 / AAT 5135** curved, without Lock



Barraquer

Needle holder
short model
micro jaws
ideal for 10-0 to 11-0 sutures

- AA 5140 / AAT 5140** micro, with lock
- AA 5145 / AAT 5145** micro, without lock



Barraquer

Needle holder
very delicate jaws
ideal for 8-0 to 11-0 sutures

- AA 5150 / AAT 5150** straight, with lock
- AA 5155 / AAT 5155** straight, without lock
- AA 5160 / AAT 5160** curved, with lock
- AA 5165 / AAT 5165** curved, without lock



Barraquer

Needle holder
extra delicate, micro jaws
ideal for 10-0 to 11-0 sutures

- AA 5170 / AAT 5170** micro, with lock
- AA 5175 / AAT 5175** micro, without lock



Barraquer

Needle holder
standard, micro jaws
ideal for 10-0 to 11-0 sutures

- AA 5176 / AAT 5176** micro, with lock
- AA 5177 / AAT 5177** micro, without lock



Barraquer

Needle holder
standard jaws, curved
ideal for 4-0 to 7-0 sutures

- AA 5180 / AAT 5180** curved, with lock
- AA 5185 / AAT 5185** curved, without lock



Troutman

Needle holder
delicate, strongly curved jaws
ideal for 8-0 to 11-0 sutures

- AA 5190 / AAT 5190** with lock
- AA 5195 / AAT 5195** without lock



Anis

Needle holder
extra delicate jaws

- AA 5200 / AAT 5200** straight, with lock
- AA 5205 / AAT 5205** straight, without lock
- AA 5210 / AAT 5210** curved, with lock
- AA 5215 / AAT 5215** curved, without lock



McIntyre

Fish hook needle holder
straight

- AA 5220 / AAT 5220** with lock
- AA 5225 / AAT 5225** without lock



Castroviejo

Blade breaker and holder

- AA 5400 / AAT 5400** small (90mm)
- AA 5405 / AAT 5405** big (120mm)



Swiss Model

Blade breaker and holder
pencil type

- AA 5420 / AAT 5420** small (90mm)
- AA 5425 / AAT 5425** big (120mm)



On Request

Troutman

Micro blade holder

- AA 5430** straight
- AA 5435** angled



On Request

Barraquer

Blade breaker and holder
flat handle with spring lock

- AA 5450** straight



Bard-Parker Handle

For disposable slot blades

AA 5460 / AAT 5460 #3 flat handle

AA 5465 / AAT 5465 #3 round handle



Chuck Handle

For holding micro wire blades

AA 5475 / AAT 5475



Bard-Parker Blade

AA 5560 #11 blade

AA 5561 #15 blade



Carbon Razor Blade

AA 5570

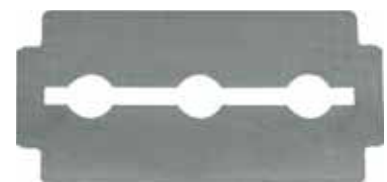

Eye Shield

Post operative - opaque
plastic green colour
non autoclave

AA 5580



Incisional instruments

Dissection Knife
0.5 mm, straight
AA 5650



Sclerotomy Knife
2.5 mm, straight
AA 5651



Specialty Knives
Subretinal spatula 1.75 mm length
45° angled
subretinal spatula 2.50 mm length
55° angled
AA 5652



Specialty Knife
Membrane delamination knife
AA 5653



Scleral Pocket Knives
2.9mm, 60° angled, Dual Bevel
2.9mm, 60° angled, Bevel Down
1.2 mm, 35° mini-disk, angled, dual bevel
1.0 mm, straight, mini-disk, bevel up.
AA 5654



CLEAR CORNEAL KNIVES



AA 555026	W=2.6mm	Double Bevel	AA 555028	W=2.8mm	Double Bevel
AA 555030	W=3.0mm	Double Bevel	AA 555032	W=3.2mm	Double Bevel



TRAPEZOID SLIT KNIVES

AA 554015	W=1.5/2.0mm	Bevel up	AA 554028	W=2.8/3.2mm	Bevel up



SCLERAL KNIFE(HOCKEY KNIFE)

	Specifications			Product No.
	Blade width	Bevel	Blade thickness	PC Handle
	Scleral knife, straight	Bi-bevel	0.38mm	AA 2400







PARACENTESIS KNIFE

AA 552010	1.0 mm straight	



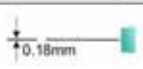

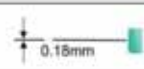

LANCE KNIVES (SIDE PORT BLADE)



AA 550009	Angle 15°	T=0.18mm	AA 550012	Angle 15°	T=0.18mm
					
AA 550015	Angle 15°	T=0.18mm			
					















TUNNEL KNIVES

AA 551021	W=2.1mm	Bevel up	AA 551026	W=2.6mm	Bevel up
					











SLIT KNIVES (ENTRY KERATOME BLADE)

AA 552016	W=1.6mm	Bevel up	AA 552018	W=1.8mm	Bevel up
					
AA 552026	W=2.6mm	Bevel up	AA 552028	W=2.8mm	Bevel up
					
AA 552030	W=3.0mm	Bevel up	AA 552032	W=3.2mm	Bevel up
					



SLIT ENLARGE KNIVES

AA 553050	W=5.0mm	Bevel up	AA 553051	W=5.1mm	Bevel up
					
AA 553052	W=5.2mm	Bevel up	AA 553055	W=5.5mm	Bevel up
					





STAB KNIVES (LANCE)

CATALOGUE NO	TYPE
AA 590012	15", 1.2mm
AA 590015	15", 1.5mm



CRESCENT KNIVES (TUNNEL)

CATALOGUE NO	TYPE
AA 591021	2.1 mm Bevel up
AA 591026	2.6 mm Bevel up



SLIT KNIVES (ENTRY KERATOME BLADE)

CATALOGUE NO	TYPE
AA 592014	1.4 mm Bevel up
AA 592018	1.8 mm Bevel up
AA 592020	2.0 mm Bevel up
AA 592022	2.2 mm Bevel up
AA 592024	2.4 mm Bevel up
AA 592028	2.8 mm Bevel up
AA 592028	3.0 mm Bevel up
AA 592028	3.2 mm Bevel up



IMPLANT KNIVES (SLIT ENGLARGE)

CATALOGUE NO	TYPE
AA 593050	5.0 mm Bevel up
AA 593052	5.2 mm Bevel up
AA 593055	5.5 mm Bevel up



LANCE KNIVES (SIDE PORT BLADE)



AA 560009 15° straight 0.9 mm
AA 560012 15° Straight 1.2 mm
AA 560015 15° Straight 1.5 mm

AA 560209 22.5° straight 0.9 mm
AA 560212 22.5° Straight 1.2 mm

TUNNEL KNIVES (CRESCENT BLADE)



AA 561012 2.1 mm Angled Bevel Up
AA 561026 2.6 mm Angled Bevel Up

SLIT KNIVES (ENTRY KERATOME BLADE)



AA 562014 1.4 mm Angled Bevel Up
AA 562018 1.8 mm Angled Bevel Up
AA 562020 2.0 mm Angled Bevel Up
AA 562022 2.2 mm Angled Bevel Up
AA 562024 2.4 mm Angled Bevel Up
AA 562026 2.6 mm Angled Bevel Up

AA 562027 2.7 mm Angled Bevel Up
AA 562027 2.75 mm angled bevel up
AA 562028 2.8 mm Angled Bevel Up
AA 562030 3.0 mm Angled Bevel Up
AA 562032 3.2 mm Angled Bevel Up

SLIT ENLARGE KNIVES (IOL IMPLANT BLADE)



AA 563050 5.0 mm Angled Bevel Up
AA 563052 5.2 mm Angled Bevel Up
AA 563055 5.5 mm Angled Bevel Up

MVR VITRECTOMY KNIVES



AA 564019 19Gauge 1.0 mm Wide
AA 564020 20Gauge 0.9 mm Wide
AA 564023 23Gauge 0.8 mm Wide

AA 564119 19Gauge 1.0 mm Angled
AA 564120 20Gauge 0.9 mm Angled
AA 564123 23Gauge 0.8 mm Angled

Lance Knives (Side Port Blade)

- AA 570009** 15° straight 0.9mm
- AA 570012** 15° straight 1.2mm
- AA 570015** 15° straight 1.5mm



Tunnel Knives

- AA 571021** 2.1mm angled bevel up
- AA 571026** 2.6mm angled bevel up



Ultra Thin Phacolit Knives

- AA 572014** width 1.4mm
- AA 572018** width 1.8mm



Slit Knives

(Entry Keratome Blade)

- AA 572028** 2.8mm angled bevel up
- AA 572030** 3.0mm angled bevel up
- AA 572032** 3.2mm angled bevel up



Slit Enlarge Knives

(IOL Implant Blade)

- AA 573050** 5.0mm angled bevel up
- AA 573052** 5.2mm angled bevel up
- AA 573055** 5.5mm angled bevel up



Incision Depth Knives

- AA 575300** 300µm
- AA 575350** 350µm
- AA 575500** 500µm
- AA 575550** 550µm
- AA 575600** 600µm
- AA 575340** 400µm
- AA 575345** 450µm





Punches

Corneoscleral Punches

DCR Trephines

Lacrimal Probes

Intubation Set



Kerrison

Bone nibbling ronguer
9 mm opening

AA 6010 size 0, 1 mm wide

AA 6011 size 1, 2 mm wide

AA 6012 size 2, 3 mm wide

AA 6013 size 3, 4 mm wide

AA 6014 size 4, 5 mm wide



Citeli

Bone nibbling ronguer

AA 6020 size 0, 2 mm wide

AA 6021 size 1, 3 mm wide

AA 6022 size 2, 4 mm wide



Beyer

Bone nibbling ronguer

AA 6030 single action

AA 6035 double action



Nasal

Speculum

AA 6040 infant

AA 6041 child

AA 6042 adult



Tilley

Nasal packing forceps

AA 6045 infant



On Request

Holth

Corneoscleral punch
9 mm opening

AA 6050 1 mm

AA 6051 1.5 mm

AA 6052 2 mm



On Request

Gass

Corneoscleral punch
1.5 mm dia. tip rotatable for
convenient positioning

AA 6060



Kelly

Descemet membrane punch

AA 6070 / AAT 6070 1 mm

AA 6071 / AAT 6071 0.75 mm



Arruga

Lacrimal trephine

'T' handle with sharp

cutting edge, used

for cutting the bone with pin for primary

without pin for secondary

AA 6080 7 mm, with centre pin

AA 6081 8 mm, with centre pin

AA 6082 9 mm, with centre pin

AA 6083 10 mm, with centre pin

AA 6085 7 mm, without centre pin

AA 6086 8 mm, without centre pin

AA 6087 9 mm, without centre pin

AA 6088 10 mm, without centre pin



Arruga

Lacrimal trephine
used for cutting the
bone with pin for primary
without pin for secondary

- AA 6090** 7 mm, with centre pin
- AA 6091** 8 mm, with centre pin
- AA 6092** 9 mm, with centre pin
- AA 6093** 10 mm, with centre pin
- AA 6095** 7 mm, without centre pin
- AA 6096** 8 mm, without centre pin
- AA 6097** 9 mm, without centre pin
- AA 6098** 10 mm, without centre pin



West

Lacrimal chisel

- AA 6100 / AAT 6100** straight
- AA 6105 / AAT 6105** curved



West

Bone gouge

- AA 6110 / AAT 6110** straight



Mallet

For DCR surgery

- AA 6120**



Freer

Periosteal elevator
one end blunt
other end semi-sharp
4.5 mm wide blades

- AA 6130 / AAT 6130**



Traquair

Periosteal elevator

- AA 6140 / AAT 6140**



Pigtail

Probe
with suture holes
for lower punctum and
upper punctum

- AA 6150 / AAT 6150**



Harms

Trabeculotomy probe
with double parallel prong design
AA 6160 / AAT 6160 right
AA 6170 / AAT 6170 left



Bowman

Lacrimal probe
malleable stainless steel
AA 6175 set of 4 sizes
AA 6180 size 0000&000
AA 6180A size 000&00
AA 6190 size 00&0
AA 6200 size 1&2
AA 6210 size 3&4
AA 6212 size 5&6
AA 6214 size 7&8



Jackson

Lacrimal intubation set
includes 2 blunt stainless steel
probes, 0.9 mm dia. X 150 mm long,
supplied with 300 mm long silicone
tubing 0.30 mm I.D X 0.60 mm O.D.
AA 6220 set
AA 6225 silicone tubing



Bodian

Lacrimal probe set includes 2 curved, blunt
stainless steel probes 1.0 mm dia. X 35 mm long
supplied with 300 mm long silicone tubing
0.30 mm I.D X 0.60 O.D.
AA 6230 set
AA 6235 silicone tubing



Crawford

Lacrimal intubation includes two
olive tip stainless steel probes
0.6 mm dia. X 150 mm long
supplied with 300 mm long silicone tubing,
0.50 mm I.D X 0.94 mm O.D.
AA 6240 set
AA 6242 silicone tubing
AA 6245 retrieving hook

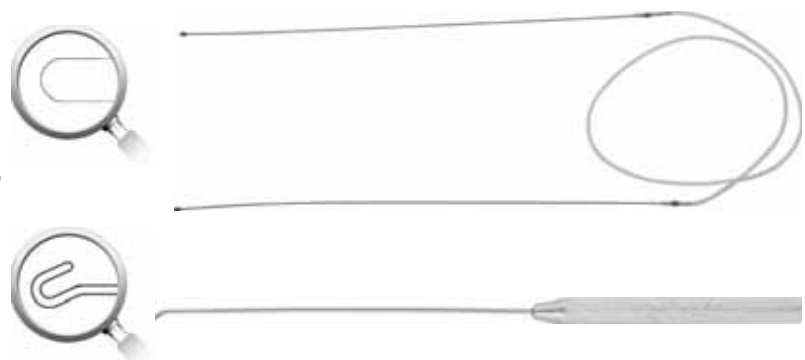

Catalano

Lacrimal intubation set
includes two blunt stainless steel probes,
0.7 mm dia x 140 mm long, supplied with
300 mm long silicone tubing
0.30 mm I.D x 0.60 mm O.D

AA 6250 set

AA 6255 silicone tubing

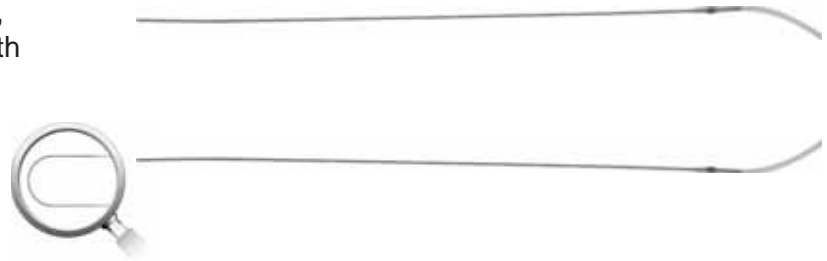

Naso-Lacrimal Probe

With irrigating side port
blunt tip supplied with
silicone tubing and adaptor

AA 6260 0.5 mm diameter

AA 6261 0.6 mm diameter

AA 6262 0.8 mm diameter

AA 6265 silicone tubing



Infant

Lacrimal dilator
very fine blunt tip
0.5 mm diameter

AA 6400 / AAT 6400



Muldoon

Lacrimal dilator
graduated blunt tip
0.5 mm diameter

AA 6405 / AAT 6405



Wilder

Lacrimal dilator
size 1, fine taper
AA 6410 / AAT 6410
size 2, medium taper
AA 6420 / AAT 6420
size 3, heavy taper
AA 6430 / AAT 6430



Castroviejo

Lacrimal dilator
double-end
fine and medium taper
AA 6440 / AAT 6440





Air Cannula

Hydrodissection Cannula

Hydrodelineation Cannula







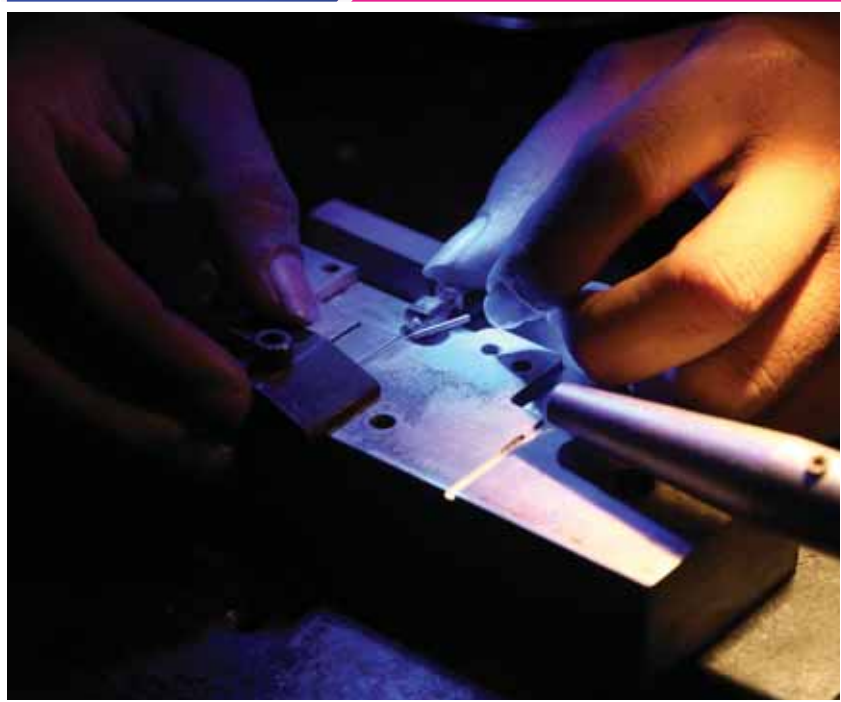

I/A Cannula

LASIK Cannula

Vitreo-Retinal Instruments



Gauge Conversion Chart

Gauge	Inner Diameter		Outer Diameter		Disposable Cannula Colour
	Inches	mm	Inches	mm	
19G	.028	.70	.043	1.10	Cream* 
20G	.024	.60	.036	.90	Yellow 
21G	.020	.51	.032	.80	Green 
22G	.016	.41	.028	.70	Black 
23G	.013	.33	.025	.60	Blue 
24G	.012	.30	.022	.55	Purple 
25G	.010	.25	.020	.50	Orange 
26G	.010	.25	.018	.45	Brown 
27G	.008	.20	.016	.40	Grey 
30G	.006	.15	.012	.30	Natural 

Needle

- AA 7001** 18 G
- AA 7002** 20 G
- AA 7003** 23 G



Anel

- Lacrimal cannula
- long hub
- blunt tip
- overall length 14 mm
- AA 7015** 23 G, straight
- AA 7016** 25 G, straight
- AA 7017** 23 G, curved
- AA 7018** 25 G, curved



McIntyre

- Lacrimal cannula
- blunt tip 0.3 mm side port
- overall length 46 mm, 23 G
- AA 7005** straight
- AA 7007** curved

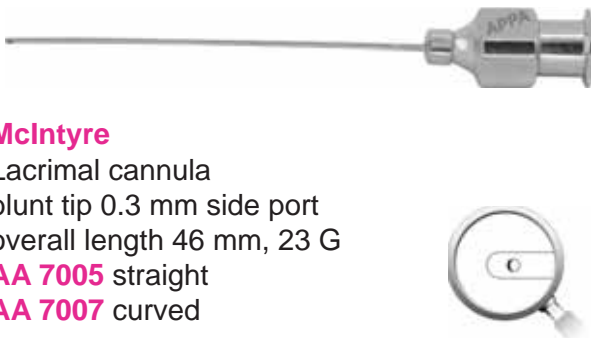

Bailey

- Lacrimal cannula
- 7 mm exposed blunt tip
- 8 mm reinforced shaft
- overall length 15 mm
- 20 G
- AA 7020**



Lacrimal

- Cannula
- 23 G malleable tip
- overall length 25 mm
- AA 7010** straight
- AA 7012** curved

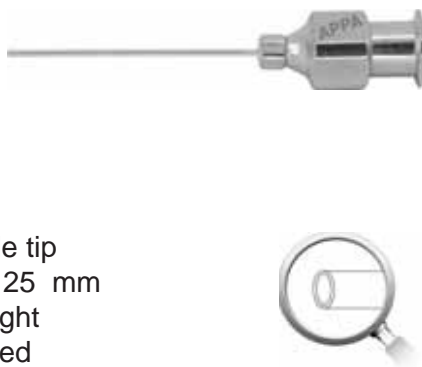

Tulevech

- Lacrimal cannula
- overall length 30 mm
- 23 G
- AA 7025**



Lacrimal

- Cannula straight
- malleable tip
- AA 7013** 27 G
- AA 7014** 30 G



Shahinian

- Lacrimal cannula
- Bullet shaped tip, 0.3mm side opening, 11mm long, 23 G
- AA 7030**



Fasanella

Lacrimal cannula
160° curved tip
overall length 15 mm
23 G
AA 7035



DALK

Air injection cannula
flattened, vaulted
0.2 mm posterior port near tip
AA 7100 27 G

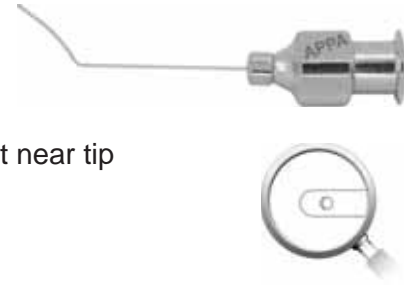

West

Lacrimal cannula
blunt tip with side port
overall length 30 mm
AA 7040 23 G

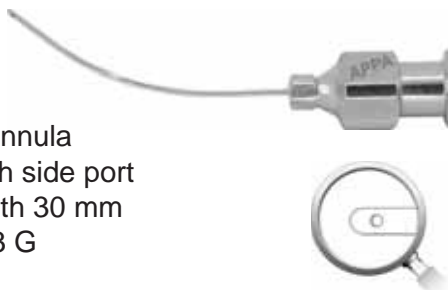

Rycroft

Air injection cannula
45° angled
5 mm angled tip
overall length 22 mm
AA 7105 16 G
AA 7105 18 G
AA 7105 19 G
AA 7105 20 G
AA 7105 21 G
AA 7105 22 G
AA 7105 23 G
AA 7105 24 G
AA 7105 25 G
AA 7106 26 G
AA 7107 27 G
AA 7108 30 G



Reinforced

Lacrimal cannula
20 G cannula with 20 mm shaft
23 G exposed 12 mm tip
malleable
overall length 32 mm
AA 7045 straight
AA 7047 curved

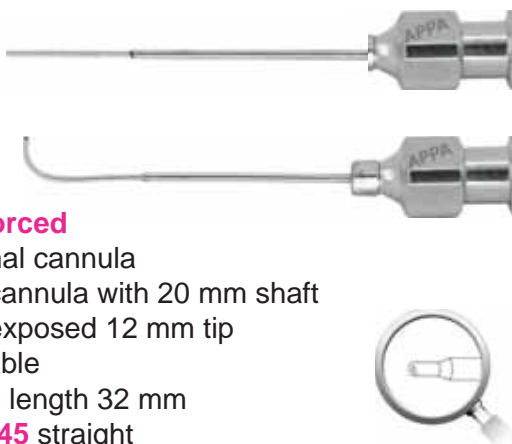

Rosenwasser

DALK cannula
flattened "cobra-shaped" tip
0.2 mm posterior port
AA 7050 27 G

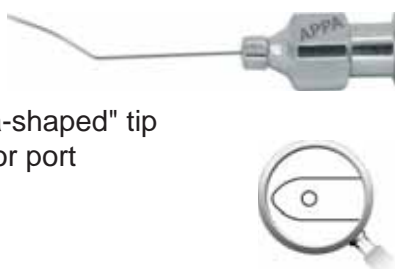

McIntyre

Anterior chamber cannula
smooth blunt tip
overall length 17 mm, straight
AA 7110 23 G
AA 7111 26 G
AA 7112 30 G



McIntyre

Anterior chamber cannula
smooth blunt tip
45° angled
12 mm angled tip
overall length 17 mm

AA 7113 23 G

AA 7114 26 G

AA 7115 30 G

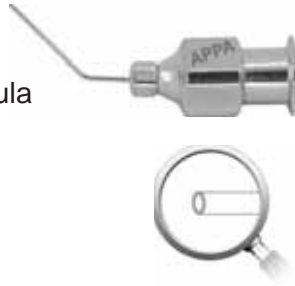

Knolle

Anterior chamber irrigating cannula
2 mm angled tip
45° angled tip
front opening
overall length 19 mm

AA 7130 23 G

AA 7132 25 G

AA 7134 30 G



DMEK Cannula

This device is used to inject air.
Using bend to tip portion, it is
easy to sweep across the
anterior segment surface to open
the graft, angled

AA 7116 23 G

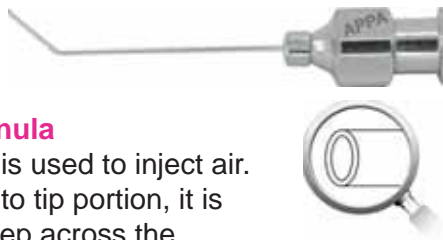

Bishop-Harmon

Anterior chamber
cannula
7 mm angled flat blunt tip
40° angled
overall length 25 mm

AA 7135 19 G

AA 7136 20 G

AA 7137 21 G



Anterior Chamber

Cannula
curved 90° flattened tip
overall length 22 mm, 27 G

AA 7120

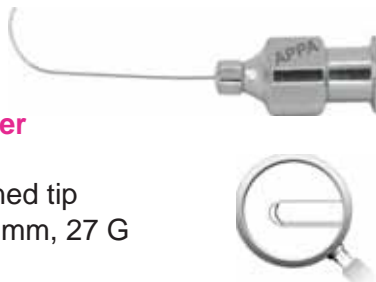

Shepard

R.K cannula
5 mm angled tip
flat blunt tip 45° angled

AA 7140 27 G

AA 7142 30 G



Bracken

Anterior chamber cannula
flattened beveled tip
angled length 7 mm
overall length 21 mm

AA 7125 16 G

AA 7125 19 G

AA 7125 20 G

AA 7125 21 G

AA 7125 22 G

AA 7125 23 G

AA 7125 24 G

AA 7125 25 G

AA 7125 26 G

AA 7125 27 G

AA 7125 30 G

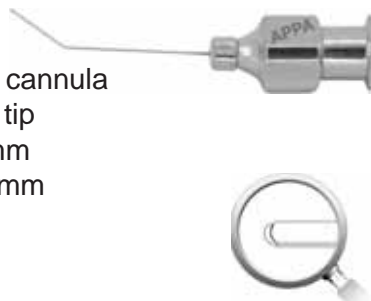

Anterior Chamber

Washout cannula
5 mm angled tip
16 G
flat blunt tip
30° angled
overall length 35 mm

AA 7145





Lewicky A/C Maintainer

Anterior chamber maintainer cannula
20 G x 3.50 mm cannula
overall length 12 mm
The self-retaining threaded tip assures stable fixation within the corneal stroma.
Cannula is connected with 200 mm long silicone tubing and adaptor
AA 7150



Brierley

chamber maintainer
tapered positive grip tip
with self retaining fins, 20 G
AA 7170



Girard

Anterior chamber maintainer cannula
23 G x 5.00 mm, cannula with Atkinson point cannula is connected with 200 mm long silicone tubing and adaptor
AA 7155



Blumenthal

Anterior chamber maintainer cannula
smooth oval tip
AA 7180 20 G
AA 7190 21 G



Heslin

Infusion cannula
23 G x 3.00 mm cannula with beveled tip. Textured tip for retention in the incision. Cannula is connected with 200 mm long silicone tubing and adaptor
AA 7160



Blumenthal

Tip is tapered to .30 mm (30G); 45° angled; 4 mm from end. Tapered to allow greater flow of fluid through a smaller tip. Provides easy insertion under capsule for hydrodissection or into nucleus for hydrodelineation.
AA 7200



Blumenthal

Cannula
irrigating cystotome (formed)
0.40x16 mm (27 Gx5/8 in)
AA 7201 5 mm angled



Rainin

Air injection cannula
spatulated blunt tip
angled at 7 mm
45° angled
overall length 32 mm
AA 7210 27 G
AA 7212 30 G



IOL Glide

35 mm length x 5 mm wide
AA 7202 silicone
AA 7203 teflon

Gimbel

'U' shaped hydrodissector
smooth blunt tip
overall length 22 mm
AA 7215 25 G
AA 7216 27 G
AA 7217 30 G



Chu

Hydrodissection cannula
Flattened, 25 G, 0.75mm long
spatulated tip, length 22 mm
AA 7204



Feaster

Hydrodissection cannula
wedge shaped tip
dual side ports, curved
length 22 mm
AA 7218 25 G



Pearce

Hydrodissection cannula
35° angled
8 mm flat blunt tip
overall length 22 mm
AA 7205 16 G
AA 7205 18 G
AA 7205 20 G
AA 7205 21 G
AA 7205 22 G
AA 7205 23 G
AA 7205 24 G
AA 7205 25 G
AA 7206 26 G
AA 7207 27 G
AA 7208 30 G



Feaster Cannula

Hydrodissection cannula
wedge shaped tip
dual side ports
angled length 7 mm
overall length 22 mm
25 G, angled
AA 7219



Nucleus Hydrolysis Needle

Flattened oval shaped tip
overall length 22 mm, curved
25 G

AA 7220



Sub tenon

Anesthesia cannula
0.3 mm ports, blunt tip
overall length 22 mm

AA 7240 19 G-dual port

AA 7241 19 G-triport

AA 7242 21 G-dual port

AA 7243 21 G-triport

AA 7244 23 G-dual port



Slade femtosecond cannula

Overall length: 24 mm
Helps to release the gas bubble
trapped beneath the nucleus during
emulsification. Creates a more
efficient hydrodissection for the
femtosecond laser procedure.

AA 7222 23 G



Arbisser

Anterior chamber cannula
angled at 5.5 mm
overall length 22 mm

AA 7245 25 G



Nishi

Irrigating capsule retractor
flattened tip
angled at 7 mm
overall length 10 mm
18 G

AA 7225



West

Irrigating cannula
0.3 mm side port
blunt tip
overall length 32 mm
23 G

AA 7250



Kellan

Hydrodelineation cannula
curved bevel tip
sharp on top
smooth on bottom
length 22 mm

AA 7230 18 G

AA 7230 22 G

AA 7230 23 G

AA 7230 24 G

AA 7230 25 G

AA 7230 26 G

AA 7230 27 G



Bimanual

Irrigating cannula

AA 7251 21 G



Binkhorst

Irrigating cannula
2.5 mm curved hook
30° angled
13 mm angled tip
overall length 35 mm
AA 7255 22 G straight
AA 7257 22 G left
AA 7259 22 G right

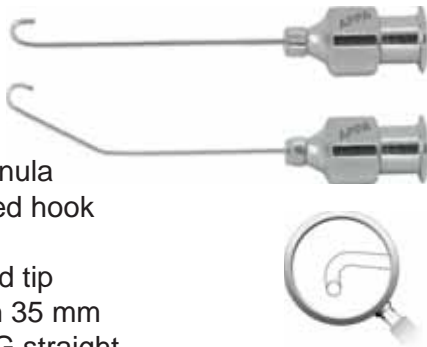

Carter

LASIK cannula
end opening flattened tip
angled at 8mm
overall length 22 mm
AA 7272 24 G



Wilbrandt-Binkhorst

Irrigating cannula
2 mm curved hook front opening
blunt tip 30 ° angled at 8 mm
overall length 15 mm
AA 7260 23 G straight
AA 7262 23 G left
AA 7264 23 G right



Salz

Irrigating capsule retractor
front opening
downward curved hook
overall length 10 mm
20 G
AA 7275



McIntyre-Binkhorst

Irrigating cannula
2 mm curved hook
front opening blunt tip
30° angled
angled at 13 mm
overall length 20 mm, 26 G
AA 7265 straight
AA 7267 left
AA 7269 right



McIntyre

Cystotome
angled at 10 mm
front opening,
upward curved tip
23 G
AA 7280



Thurmond

Nucleus irrigating cannula
and iris retractor
45 ° angled
1 mm downward curved tip
angled at 7 mm, 19 G
overall length 27 mm
AA 7270

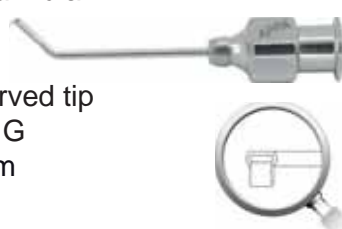

Sautter

Hydrodissection cannula
Vertically flattened tip
length 25 mm
AA 7285 27 G





Sutter

Hydrodissection cannula
Vertically flattened tip, 26 G
AA 7290



Viscoelastic

Injection cannula
angled 10 mm from tip
overall length 25 mm
AA 7309 19 G



Akahoshi

Hydrodissection cannula
tapered tip design can be
easily inserted beneath the
capsulorhexis edge
angled 2mm from end
AA 7295 27 G



Healon

Vitreous aspiration cannula
45° angled
10 mm angled
shaft with flat tip
overall length 32 mm
AA 7310 19 G angled
AA 7311 20 G angled
AA 7312 21 G angled



Chang

Cannula
for injection of heavy liquids
(PFCL) tapered tube 25 G /
0.50 mm central port for injection
0.40 mm outer shaft 20 G /
0.90 mm with 0.50 mm lateral
ports for drainage
AA 7300



Mauumenee

Vitreous aspirating cannula
straight blunt tip, front opening
marking at 5 mm, 10 mm and 15 mm
overall length 25 mm
AA 7314 18 G



Gills

Aspirating cannula
45° angled
front opening, blunt tip
overall length 20 mm, 25 G
AA 7305 angled at 5 mm
AA 7306 angled at 7 mm
AA 7307 angled at 8 mm
AA 7308 angled at 10 mm



Salz

Aspirating cannula
straight, blunt tip
overall length 15 mm
23 G
AA 7315





Jacobi

Trabecular aspirating cannula
angled length 13 mm
overall length 30 mm
AA 7316 24 G



Morrison

Aspirating cannula
7 mm angled tip
blunt tip
overall length 25 mm
23 G
AA 7325



Aspirating cannula
Delicate
19 G / 1.10 mm
overall length 30 mm
AA 7317



Simcoe

Cortex extractor cannula
light curved shaft
closed tip with 0.3 mm
side opening
AA 7330 23 G 13 mm
AA 7332 23 G 21 mm
AA 7332A 25 G 25 mm



Aspirating cannula
17 G/ 1.50 mm
overall length 23 mm
AA 7318



Anis

Cortex aspirating cannula
closed tip with 0.4 mm
side port finely sand
blasted tip 23 G
overall length 30 mm
AA 7335 straight
angled length 3 mm
AA 7337 angled



Gimbel

Cortex aspirating cannula
2 mm angled from tip to first bend
10 mm angled from first bend
to second bend
blunt tip
overall length 17 mm
30 G
AA 7320



Simcoe - Welsh

Cortex extractor cannula
45° angled
10 mm angled tip
closed tip with 0.3 mm
aspiration port
overall length 20 mm
AA 7340 23 G





Troutman

Alpha-Chymotrypsin cannula
curved shaft
smooth bulbous tip
overall length 26 mm, 25 G
AA 7345



Weber

Aspirating cannula
for viscous fluid
inside : 22 G / 0.7 mm
outside : 20 G / 0.9 mm
AA 7365



Gills - Welsh

Olive tip cannula
45° angled
10 mm angled tip
smooth bulbous tip
overall length 26 mm, 25 G
AA 7350



Weber

Aspirating cannula
for viscous fluid
inside : 20 G / 0.9 mm
outside : 18 G / 1.2 mm
AA 7366



Welsh

Flat olive tip cannula
45° angled
8 mm angled tip
flat olive tip
overall length 23 mm, 25 G
AA 7355 straight
AA 7357 left
AA 7359 right



Micro

'U' shaped aspirating cannula
2 mm curved flat tip
overall length 22 mm
AA 7370 21 G
AA 7372 23 G
AA 7374 25 G



Healon cannula

8 mm angle from tip
overall length 30 mm
21 G, 45° angled
AA 7360



McIntyre

Coaxial irrigating- aspirating system
includes: 1 each AA 7405, AA 7407,
AA 7408 and AA 7409
AA 7400 complete
inner cannula 23 G
AA 7405 0.2 mm side port
AA 7407 0.2 mm side port
truncated outer cannula
19 G, side ports
AA 7408
nylon connector
AA 7409



Appasamy

Aspirating handle

AA 7410



Appasamy

Irrigating handle

AA 7411



Simcoe

Irrigating / Aspirating cannula

Original model (direct)

Aspiration through silicone tube &

irrigation through main hub

Curved shaft overall length 16 mm

AA 7418A 20 G 0.5 mm aspiration port

AA 7418 21 G 0.5 mm aspiration port

AA 7419 22 G 0.35 mm aspiration port

AA 7420 23 G 0.30 mm aspiration port



Reverse Simcoe

Irrigating / Aspirating cannula

irrigation through the silicone

tube and aspiration through

the main hub

AA 7423 21 G 0.50 mm aspiration port

AA 7424 22 G 0.35 mm aspiration port

AA 7425 23 G 0.30 mm aspiration port



Simcoe

Irrigating / Aspirating cannula

sand blasted, original model (direct)

tips are sand blasted

for polishing posterior capsule

AA 7429 22 G 0.35 mm aspiration port

AA 7430 23 G 0.30 mm aspiration port



Simcoe

Irrigating / aspirating cannula
Reverse model
tips are sand blasted
for polishing posterior capsule

AA 7434

22 G 0.35 mm aspiration port

AA 7435

23 G 0.30 mm aspiration port

AA 7435A

21 G 0.50 mm aspiration port



Swiss

Irrigating / aspirating cannula
Aspiration through silicone tubing
irrigation through main hub
0.3 mm port on left side of
aspirating tube, curved irrigating tip
23 G overall length 16 mm

AA 7440



Gills

Irrigating / aspirating cannula
30° angled
8 mm angled tip
irrigation through main hub
aspiration through silicone tubing
both tips are open
23 G

AA 7445



Ruit

Irrigating / aspirating cannula
Original model with serrated
aspiration through silicone tube &
irrigation through main hub
curved shaft, overall length 16 mm
0.30 mm aspiration port.

AA 7446 21 G

AA 7447 23 G

AA 7448 22 G



Morrison

Irrigating / aspirating cannula
45° angled
7 mm angled tip
aspiration through 23 G
main hub, front opening.
Irrigating through 25 G
thinwall and adaptor with silicone
tubing irrigating tube with
0.3 mm side opening
recessed 1.5 mm from tip
overall length 17 mm

AA 7450



Morrison

Irrigating / aspirating cannula
45° angled
7 mm angled tip
aspiration through 22 G
main hub, front opening
irrigating through 24 G
thinwall and adaptor with silicone
tubing irrigating tube with
0.3 mm side opening
recessed 1.5 mm from tip supplied
overall length 17 mm

AA 7452



Gills-Welsh

Irrigating / aspirating cannula
20° angled shaft
10 mm angled tip
aspiration through main hub 25 G
aspiration tip 3 mm long with olive tip
irrigation through silicone tubing
overall length 24 mm

AA 7455 straight

AA 7456 left

AA 7457 right



Jensen-Thomas

Irrigating / aspirating cannula
with 0.3 mm side openings
23 G supplied with silicone
tubing and adaptor
overall length 22 mm

AA 7460



Grandon

Irrigating / aspirating cannula
Gently curved
0.3 mm aspirating port facing into curve.
Irrigating tip with 0.3 mm
side port is recessed 2.5 mm
23 G x 27 mm supplied with
silicone tubing and adaptor

AA 7465



Grandon

Irrigating /aspirating cannula
slightly curved shaft
0.3 mm aspirating port facing
into curve.
0.3 mm irrigating tip is recessed 2.5 mm
23 G thin walls.
Supplied with silicone tubing and adaptor
overall length 27 mm

AA 7467 left

AA 7469 right



Gess

Irrigating /aspirating cannula
aspiration through silicone tubing
and irrigating through main hub
'J' shaped front opening
tip for aspiration
between 11 and 1 o' clock
supplied with silicone tubing
and adaptor
23 G

AA 7470 left for 1 o' clock

AA 7471 right for 11 o' clock



'J' shaped I/A Cannula

Irrigating / aspirating cannula
aspiration through silicone tube and
irrigation through main hub
0.3 mm aspiration port

AA 7480 left



'J' Shaped I/A cannula

Irrigating / aspirating cannula
irrigation through silicone tube &
aspiration through main hub
0.3 mm aspiration port
AA 7482 right



Burk

Irrigating
trabeculotomy cannula
overall length 32 mm
AA 7485 right

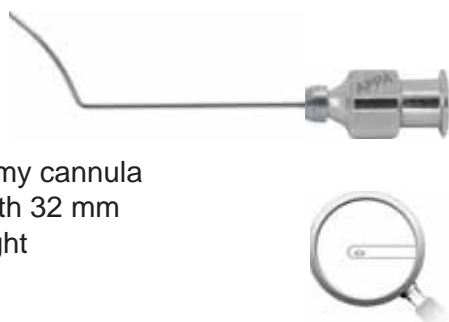

Roider

Aspirating cannula
for viscous fluid
lateral aspiration port 0.7 mm
19 G / 1.0 mm
AA 7491

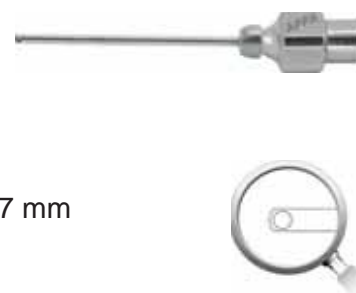

Burk

Irrigating
trabeculotomy cannula
overall length 32 mm
AA 7486 left

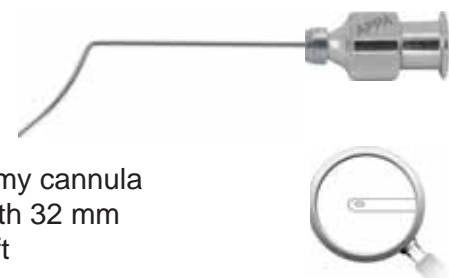

Enzyme Cannula

24 G / 0.60 mm
AA 7495



Bartz-Schmidt

Cannula for retinal detachment
20 G / 0.9 mm
2 lateral ports 0.5 mm
90° transposed
tapered tube 19 mm
25 G / 0.5 mm
with probe tip 0.9 mm
aspirating port 0.15 mm
AA 7490

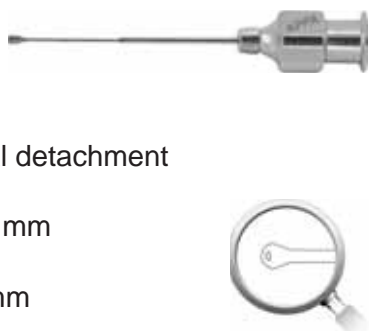

Irrigating cannula

For viscocanalostomy
30 G, 5mm angled, tapered tip
overall length 20mm, 25 G
AA 7500

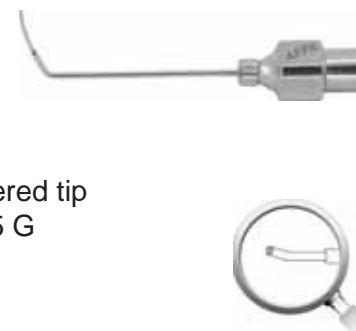



Atkinson
Peribulbar Needle
AA 7502



Silicone Oil Removal Cannula
AA 7518 19 G



Atkinson
Retrobulbar needle
beveled sharp rounded point
length 38 mm
AA 7505 23 G
AA 7507 25 G



High Viscosity Injector Cannula
16 G 9 mm
AA 7519



Appasamy
Needle 30 G for aspirating
intra-vitreous fluid
AA 7510 25 mm
AA 7512 12 mm



Bevel
Short needle
12 mm length
AA 7520 26 G
AA 7522 27 G
AA 7524 30 G



Burk
Peribulbar needle
beveled rounded point
overall length 22 mm
AA 7515 23 G
AA 7516 25 G
AA 7517 27 G



Bevel
Long needle
length 19 mm
AA 7525 26 G
AA 7526 27 G
AA 7527 30 G





Irrigating cystotome

Formed, straight
overall length 30 mm

AA 7530 25 G

AA 7531 27 G

AA 7532 30 G



Kelman

Cystotome
22 G, Blunt on all sides,
sharp at the tip
overall length 32 mm

AA 7560



Cystotome

Irrigating cystotome
formed, angled
overall length 22 mm

AA 7535 25 G

AA 7536 27 G

AA 7537 26 G

AA 7540 30 G



Kratz

Cystotome
60° angled
12 mm angled from tip
sharp tip
22 G shaft
overall length 13 mm

AA 7565



Kelman

Cystotome
sharp tip
22 G shaft
overall length 32 mm

AA 7550



McIntyre

Cystotome sharp
45° angled
sharp tip
22 G shaft
overall length 14 mm

AA 7570



Knolle - Kelman

Cystotome
sharp tip, small blade
22 G shaft
overall length 32 mm

AA 7555



Kelman

Double blade cystotome
Sharp tip
22 G shaft
overall length 32 mm

AA 7575



Double Edge

Cystotome
22 G, with a sharp point and
beveled cutting edge on all side
overall length 20 mm

AA 7580



Jensen

Capsule polisher
sand blasted olive tip
curved shaft
overall length 28 mm

AA 7605 23 G

AA 7606 25 G



Double Edge

Cystotome sharp
Double side sharp cutting edges
22 G shaft
overall length 23 mm

AA 7585



Khokkar

Capsule staining cannula, 23 G

AA 7607



Blunt

Irrigating cystotome
formed, blunt tip
22 G shaft
tip bend towards bevel
overall length 22 mm

AA 7590



Akahoshi

Visco cannula
with an oval port
at its external tip
for perfect staining
of the capsule, 27 G

AA 7608 curved



Capsulorhexis cystotome

25 G X 22 mm
AA 7595 straight
AA 7597 angled



Knolle

Capsule polisher
45° angled
2 mm angled from tip
front opening and sand blasted
overall length 13 mm

AA 7610 23 G

AA 7615 30 G



Kraff

Posterior capsule polishing curette
25 G shaft
1.75 mm diameter cup
with semi sharp
irrigating port in centre of cup
AA 7620 25 G

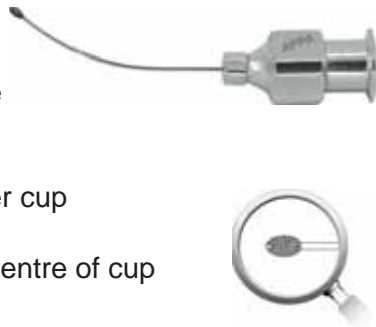

Kratz

Posterior capsule scratcher
1 mm angled, sand blasted
front opening tip
overall length 12 mm
AA 7635 23 G
AA 7636 25 G

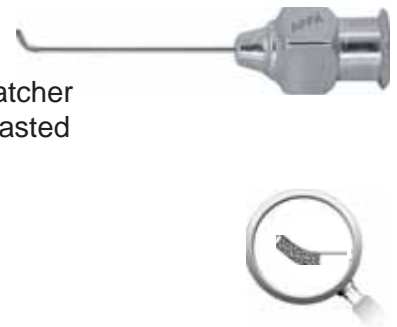

Henderson

MICS capsule polishing cannula
finely textured, 1.2 mm wide
disc-shaped tip, with 0.5 mm posterior
facing port, 23 G
AA 7621



Rubman - Katzin

Posterior capsule polisher
Carbide impregnated tip with
smooth closed end, irrigating side
port facing into curve, 22 G
AA 7640



Drews

Posterior capsule polisher
angled ring port on
inside at 6 'o' clock
sand blasted posterior surface
25 G
AA 7625



Shapiro

Posterior capsule polisher
0.3 mm dual side port with closed
tip, curved shaft, 23 G
sand blasted tip
overall length 18 mm
AA 7645



Graether

Collar button polisher
iris retractor with sand blasted
posterior surface, 23 G
overall length 25 mm
AA 7630 straight
AA 7632 angled

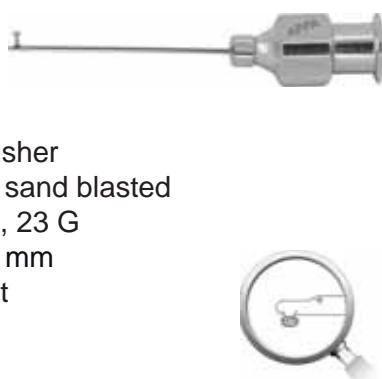

Simcoe

Anterior capsule scrubber
45° angled, 14 mm front tip
23 G sand blasted tip
overall length 19 mm
AA 7650



Simcoe

Posterior capsule scrubber
45° angled, 14 mm front tip
23 G sand blasted tip
overall length 19 mm

AA 7652

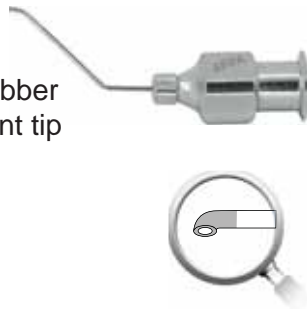

Chang

Hydrodissection cannula
flat beveled tip 90° angled
27 G

AA 7666



Lahane

Capsulorhexis and
posterior capsule
polisher, irrigating
vacuum action left hand
aspirating angled shaft
23 G with 0.3 mm
reverse aperture

AA 7653

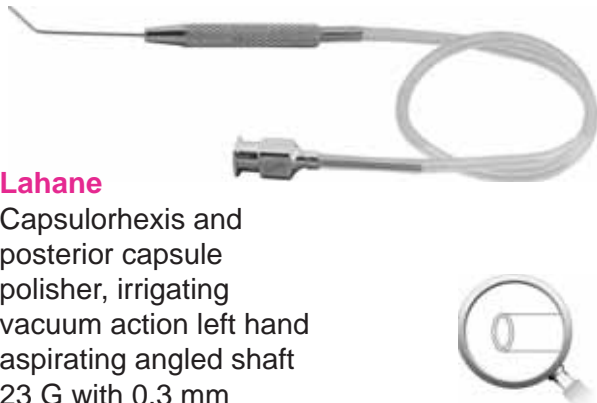

Freeman

Posterior capsule polisher
12 mm angled tip
4 mm sand blasted tip
with three irrigating holes
on tip and sides
overall length 32 mm
19 G

AA 7670

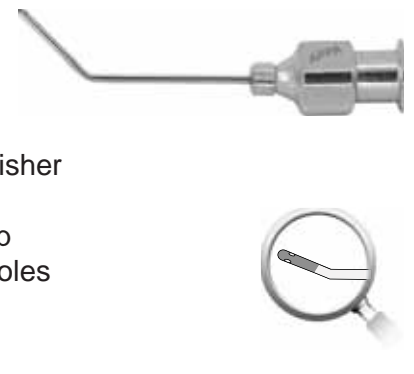

Simcoe

Posterior capsule polisher
0.3 mm bottom port, sand blasted tip
curved shaft
overall length 13 mm
23 G

AA 7655



Akahoshi Ring Levitator

To lift a dropping nucleus form
pars plana the viscoelastic
material can help in levitation

AA 7675



Simcoe

Cortex extractor
0.3 mm side port tip closed
sand blasted tip
curved shaft 23 G

AA 7660 13 mm

AA 7665 21 mm



Alfonso-McIntyre

Irrigating nucleus spoon
single 0.3 mm front open
port for extracting nucleus
fragments during manual
small incision surgery

AA 7680 2.5 mm wide

AA 7681 4.0 mm wide



Zirm

LASIK dissector cannula
25 G/0.5 mm
AA 7685

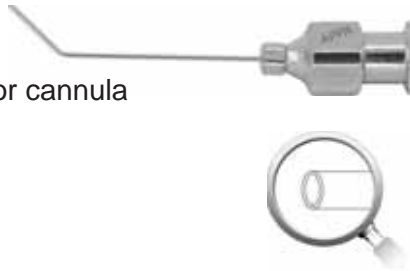

Sheets

Irrigating vectis
6 mm wide, 19 mm long loop
three irrigating ports at 12, 10 &
2 o' clock positions
serration on top of vectis
21 G
AA 7715



Zirm

LASIK Irrigating cannula
20 G/0.9 mm
AA 7690



Anis

Irrigating vectis
5 mm wide, 7 mm long loop
two irrigating ports
overall length 36 mm
AA 7720 23 G

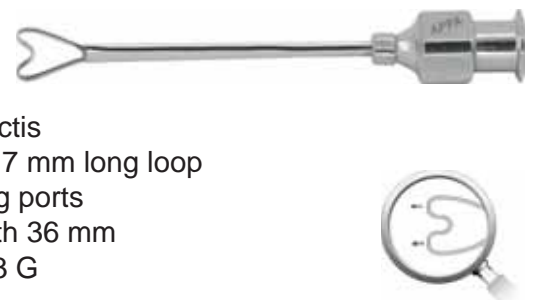

Knolle-Pearce

Irrigating vectis
ports on outer side
overall length 38 mm
AA 7705 20 G
(4 mm wide, 7 mm long loop)
AA 7706 23 G
(5 mm wide, 6 mm long loop)
AA 7707 23 G
(4 mm wide, 10 mm long loop with
half plate)

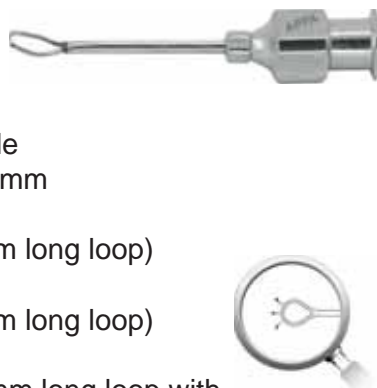

Simcoe

Nucleus delivery cannula
4 mm wide, 15 mm long loop,
13 mm overall length
two irrigating ports
serration on loop, 25 G
AA 7725 left



Drews

Irrigating vectis
6 mm wide, 9 mm long loop
one forward and two
reversed irrigating ports
overall length 35 mm
AA 7710

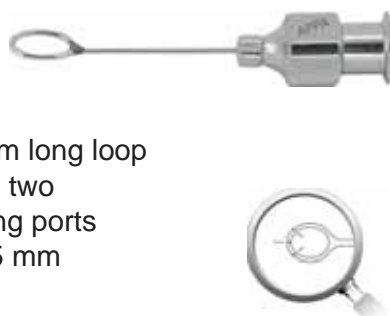

Simcoe

Nucleus delivery cannula
4 mm wide, 15 mm long loop,
13 mm overall length
two irrigating ports
serration on loop, 25 G
AA 7726 right



Nishi

Nucleus delivery cannula
irrigating cannula for lens
nucleus delivery
AA 7730 left



Small incision nucleus

Delivery cannula
5 mm wide, 10 mm long
21 G loop,
0.5 mm single
front opening port
AA 7750

Nishi

Nucleus delivery cannula
irrigating cannula for lens
nucleus delivery
AA 7732 right



Youens

Lens manipulating cannula
45° angled
10 mm angled flat tip
0.3 mm diameter tip
30 G, overall length 15 mm
AA 7755



Micro

Irrigating vectis
lightly angled loop
irrigating port facing
out side circle
AA 7740 21 G
AA 7741 23 G



Kuglen

Irrigating lens manipulator
disc shaped tip with 0.25 mm
diameter
peg protruding from its centre.
overall length 26 mm, 25 G
AA 7760 straight
AA 7762 angled



Hoffman

Nucleus loop
4 mm wide, 14 mm long
curved loop
16 G shaft with 25 G loop
three irrigating ports
serrated loop
overall length 32 mm
AA 7745



Kratz

Lens manipulating cannula
0.2 mm diameter front opening tip
45° angled
10 mm angled tip
overall length 15 mm
30 G
AA 7765



Osher

Lens manipulating cannula
24 G shaft
30 G working tip
0.2 mm side port and pigtail tip
overall length 23 mm

AA 7770

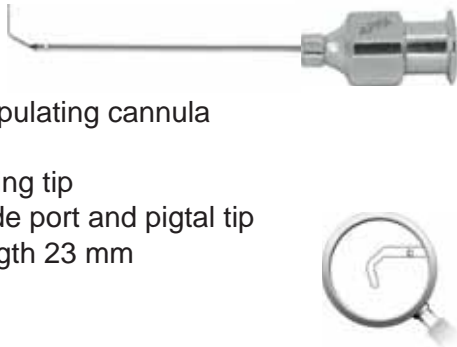

Sheets

Cyclodialysis
flattened 12 mm tip
irrigating port on both sides
and front tip opening
overall length 32 mm
2.5 mm angled up tip, 19 G

AA 7815

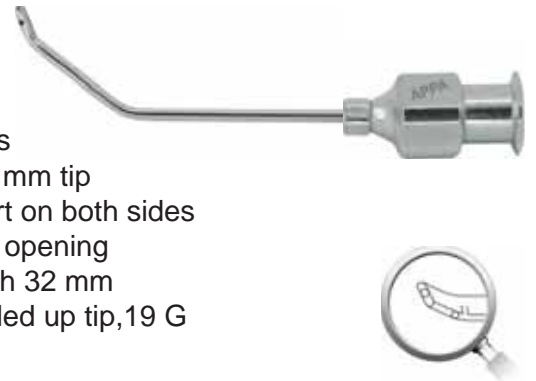

Bechert

IOL cannula
45° angled
5 mm angled tip
horizontal groove on tip
overall length 19 mm, 27 G

AA 7775

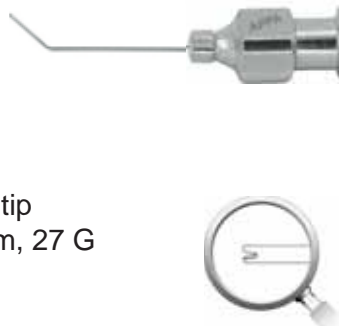

Gans

Cyclodialysis cannula
opening on left side
12 mm angled tip
19 G

AA 7820



Castroviejo

Cyclodialysis cannula
45° angled
15 mm angled flattened tip
semi-sharp sides
19 G
overall length 27 mm

AA 7805

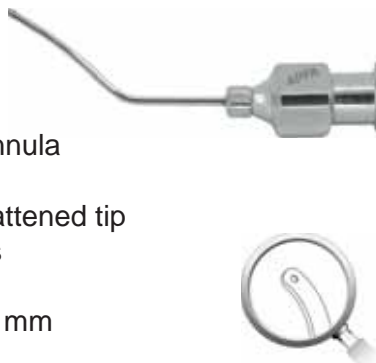

Gans

Cyclodialysis cannula
both sides opening
12 mm angled tip
19 G

AA 7822



Kelman

Cyclodialysis cannula
45° angled
12 mm angled flattened tip
side opening, 19 G
overall length 32 mm
2.5 mm angled up tip

AA 7810 right opening
AA 7812 left opening

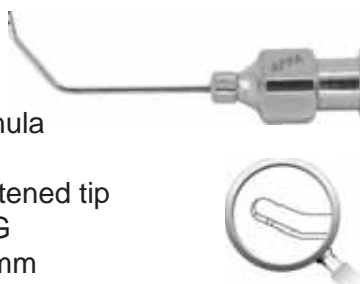

Randolph

Cyclodialysis cannula
curved spatulated tip
19 G, 13 mm angled tip
overall length 29 mm
opening in front

AA 7825 19 G
AA 7827 21 G





Silicone
Bulb with adaptor
AA 7830
Adaptor
AA 7835

Viscoelastic
Cannula
45° angled, 8 mm
angle from tip
overall length 30 mm
AA 7852 19 G
AA 7853 23 G



Simcoe
Nucleus spatula
25 G x 12 mm angled
2 mm vertical spatula tip
opening on right side
17 mm overall length
AA 7840

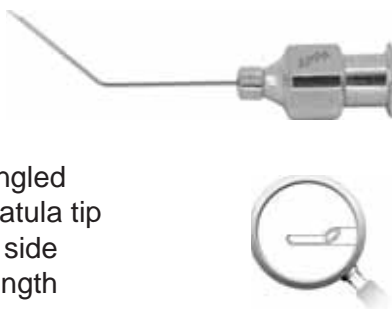

Vidaurri LASIK flap irrigator
Parallel cannula
each with four ports
simultaneously irrigated
both sides of the LASIK flap
angled 10 mm
overall length 25 mm
AA 7855 25 G
overall length 36 mm
AA 7856 25 G
overall length 33 mm
AA 7857 24 G
AA 7858 26 G
AA 7859 27 G



Silicone tube
O.D 2.4, I.D 0.9
tube with adaptor
AA 7845
AA 7846 tube only



Quad ported
LASIK irrigating cannula
four ports to irrigate
the surgical interface and
flush the debris
overall length 35 mm
AA 7860 23 G

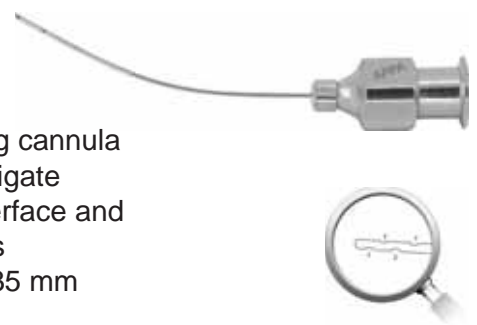

LASIK
Cannula
overall length 25 mm
AA 7850 straight
AA 7851 curved



Buratto
LASIK cannula
one front and two side ports
designed for equal flow in three
directions.
AA 7861 23 G
AA 7862 25 G

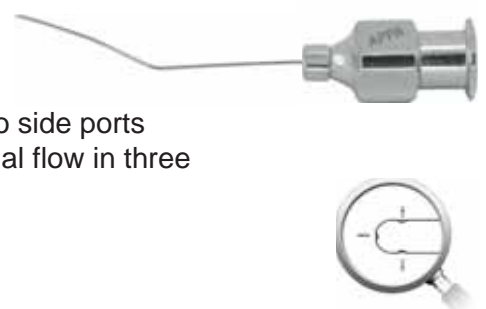



Kritzinger

23 G, Aspiration ports: 5. Irrigates fluids, numerous ports prevent the needs from being occluded by conjunctiva and ensures continuous aspiration of BSS fluid

AA 7863 23 G



Gimbel LASIK

Fountain Cannula right, angled 12 mm with vaulted smooth bullet shaped tip single center port, 13 mm overall length

AA 7875 25 G



Kritzinger

19 G, Aspiration ports: 5. Irrigates fluids, Numerous ports prevent the needs from being occluded by conjunctiva and ensures continuous aspiration of BSS fluid

AA 7864 19 G



Banaji LASIK

Cannula (6 ports) 45° angled 10 mm overall length 22 mm

AA 7880 25 G



Nichamin

LASIK irrigating cannula flattened tip, with 12 mm, slightly formed curvature, open ended for elevating the corneal flap and irrigation overall length 25 mm

AA 7865 23 G

AA 7866 25 G

AA 7867 27 G



Buratto LASIK

cannula (3 ports) 45° angled 8 mm overall length 23 mm

AA 7885 23 G

AA 7886 25 G



Nichamin

LASIK irrigating cannula flattened tip, with 6 mm, slightly formed curvature, open ended for elevating the corneal flap and irrigation overall length 25 mm

AA 7870 23 G

AA 7871 25 G

AA 7872 27 G

AA 7873 24 G

AA 7874 26 G



Nichamin

LASIK irrigating cannula 3 ports 45° angled 8 mm overall length 28 mm

AA 7887



Spatulated

LASIK cannula
60° angled, 10 mm
flattened tip
overall length 25 mm
26 G
AA 7890



Pressure Line Adapter AA 7904



Rubenstein LASIK

Irrigating cannula
6 ports, 2 ports on top,
2 on bottom and
2 on the front center
2 mm wide, 4 mm long loop
overall length 31 mm, 23 G
AA 7891



Packo Pars plana cannula AA 7905

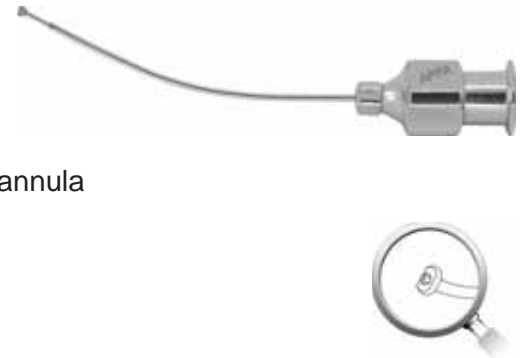

20 PSI vitrectomy cutter

For 20 psi surgery systems,
autoclavable
AA 7900 20 G
AA 7901 23 G
AA 7902 25 G



Packo Back flush needle 20 G, blunt tip only AA 7909 19 G, blunt tip only AA 7910



Posterior

4500 cpm, 5040 cpm
30psi
AA 7900 P 20 G
AA 7901 P 23 G
AA 7902 P 25 G



Packo Back flush needle 20 G, side opening tip only AA 7911





Subretinal injection

Cannula needle
AA 7912
straight



Packo

Subretinal fluid
drainage needle
20 G with 25 G tip
side opening
AA 7914



Subretinal injection

Cannula needle
AA 7913 curved



Tapered

Extrusion hand piece cannula
20 G 35 mm,
2 mm tapered, 27 G, blunt
AA 7915
AA 7916 needle only 20 G



Charles

Flute needle cannula
extrusion hand piece
20 G, 35 mm, blunt tip
AA 7920
AA 7921 needle only 20 G





Charles flute cannulas

Designed to aspirate blood and debris from the posterior segment smooth, finished tip provides atraumatic entry and reduces risk of trauma to surrounding tissue.

- AA 7915 A** 23 G
- AA 7915 B** 25 G

Soft tip cannulas

Flexible tip allows atraumatic entry through retinal or macular holes and enables aspiration of subretinal fluid

- AA 7917** 20 G
- AA 7917 A** 23 G
- AA 7917 B** 25 G

Brush tip cannulas

For atraumatic brushing of retina.

- AA 7921 A** 23 G
- AA 7921 B** 25 G

Diamond dusted soft tip cannulas

Designed for better cohesion and Gentle sweeping of the membrane

- AA 7922** 20 G
- AA 7922 A** 23 G



Charles Flute Cannula

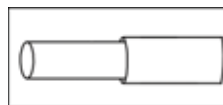

Soft Tip Cannula

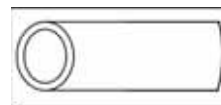

Brush Tip Cannula

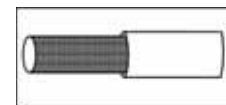

Diamond Dusted Cannula

Scleral plug forceps

Designed to securely hold scleral plugs during insertion and removal. Cross action handle reduces hand fatigue while grasping plug

AA 7925



Watzke

Sleeve spreading forceps serrated 10 mm tips angled 30° serrated cross action handle

AA 7930



TROCAR CANNULA SYSTEM

Disposable one step trocar system

Flat stiletto knife for smooth incision
 unique closure valve system
 proximal end with 3.0 mm and 4.0 mm
 scleral marker
 each pack includes:
 trocar knife with preloaded trocar cannula - 4
 pre loaded trocar cannula plug - 4
 infusion line - 1
 sterile pack

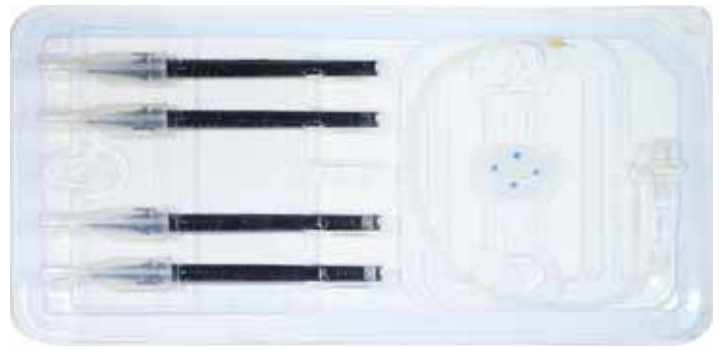

Trocar Cannula Plug



Trocar Cap



AAD 7939 23 G
AAD 7939 A 25 G
AAD 7939 B 27 G

AAD 7936 23 G



AAD 7936 A 25 G



AAD 7936 B 27 G



VALVED TROCAR CANNULA SYSTEM

Valved Trocar Cannula Plug



AAD 7941 23 G



AAD 7941 A 25 G



AAD 7941 B 27 G



ACCESSORY (CAN BE ORDERED SEPARATELY)

Trocar Loading Forceps
AA 3712



Trocar Fixation Plate
AA 7945



Trocar Infusion Cannula

Packaged sterile
AAD 7965 23 G
AAD 7966 25 G
AAD 7967 27 G



Scleral Plugs

AA 7950 18 G

AA 7951 19 G

AA 7952 20 G



Infusion Cannula

20 G, luer lock adopter &
250 mm of silicone tubing

AA 7960 2.5 mm beveled tip

AA 7961 4.0 mm beveled tip

AA 7962 6.0 mm beveled tip



Silicone Oil Infusion Cannula

Unique design facilitates the injection of silicone oil
and other viscous fluids.

AA 7961A 4.0 mm 20 G

AA 7962A 6.0 mm 20 G



Self-Retaining Sutureless Infusion Cannula

Sutureless fixation, Retaining ridge holds cannula in place,

AA 7961B 4.0 mm 20 G

AA 7961C 4.0 mm 23 G

AA 7962B 6.0 mm 20 G

AA 7962C 6.0 mm 23 G



45 Diopter

Irrigating contact lens
plano-concave hand held
irrigating vitrectomy lens
AA 7970



90 Diopter

Irrigating contact lens
bi-concave hand held
irrigating vitrectomy lens
AA 7975



Vitreous Lens Handle

AA 7977



Backflush Handle, Reusable

Passive aspiration
AA 7979
Active aspiration
AA 7979A



Membrane Peeler
AA 7980



Irrigating

Micro retinal pick
20 G needle 25 mm long
with 25 G x 5 mm sharp tip
cutting edges bent to 50°
AA 7993

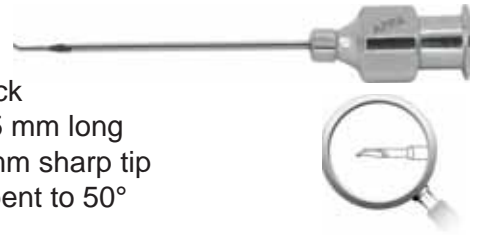

May
30° Bent Infusion Needle
AA 7985



Irrigating

Micro retinal pick
20 G needle with 2 mm
long pick
AA 7994



Packo
Subretinal fluid
drainage needle
20 G with 25 G tip
side opening
AA 7990



Irrigating

Micro retinal pick
20 G needle with 4 mm
long pick
AA 7995

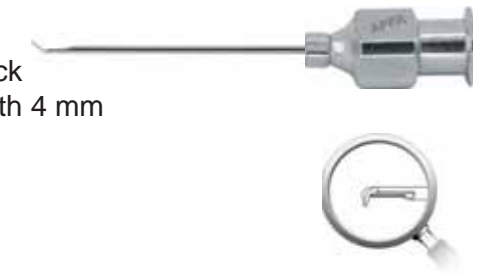

Subretinal
Fluid drainage needle
straight with silicone tip
AA 7991

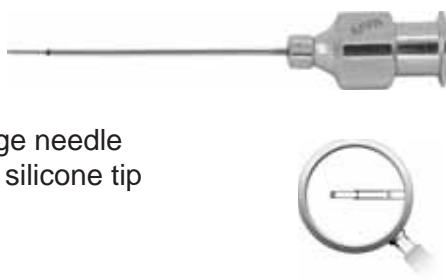

Vitreous Retinal

Viscodissector
20 G x 25 mm cannula
with 30 G x 5 mm cannula
angled 90° with a
1 mm flattened tips
AA 7996

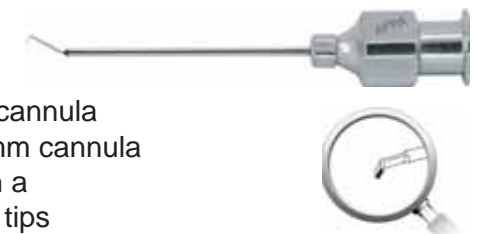

Subretinal
Fluid drainage needle
curved with silicone tip
AA 7992

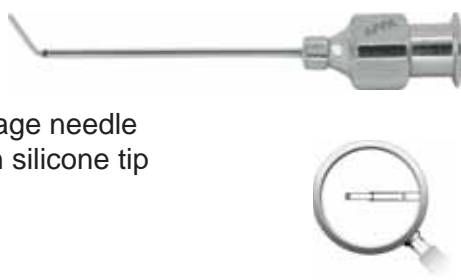

Designed for injecting or aspirating fluid under the retina. Surface of injector tip, opposite the bevel, may be used to slightly elevate the retina as fluid is injected.



Landers Subretinal Aspirator

Angled 2.5 mm

AA 4908 20 G x 1 in (.90 x 25 mm)

AA 4909 27 G x 6 mm tip

Landers Subretinal Aspirator

Curved

AA 4910 20 G x 1 in (.90 x 25 mm)

AA 4911 27 G x 6 mm tip

Glaser Subretinal Injector

Curved

AA 4912 20 G x 1 in (.90 x 25 mm)

AA 4913 33 G x 3 mm distal end



Glaser Subretinal Injector

Straight

AA 4914 20 G x 1 in (.90 x 25 mm)

AA 4915 33 G x 3 mm distal end

Glaser Subretinal Cannula

Angled 1 mm

AA 4916 20 G x 1 in (.90 x 25 mm)

AA 4917 33 G x 3 mm distal end

Peyman High Viscosity Fluid Cannula

AA 4918 16 G x 9 mm (3/8 in)

Vitreoretinal Cannulas

Cannula extends into hub reducing the chance of additional air bubble in the syringe from entering cannula.



Vander Vitreoretinal Cannula

Straight

AA 4919 20 G x 1 in (.90 x 25 mm)

AA 4920 30 G tip

Vitreoretinal Micropicks

For removing premacular, epiretinal and other vitreoretinal membranes.



Glaser Vitreoretinal Micropick

Angled 50°

AA 4923 20 G x 1 in (.90 x 25 mm)

AA 4924 25 G x 3/16 in (.50 x 5 mm)

0.5 mm sharp tip



Vander Vitreoretinal Cannula

Angled 45°

AA 4921 20 G x 1 in (.90 x 25 mm)

AA 4922 30 G (.30 mm) tip



Eaton Vitreoretinal Micropick

Angled 50°

AA 4925 20 G x 1 in (.90 x 25 mm)

AA 4926 25 G x 3/16 in (.50 x 5 mm)

0.5 mm sharp tip

RETINAL CANNULAS

Dual Bore PFC Cannula

Designed to simultaneous infusion of heavy liquids and Aspiration of intraocular fluids.

Dual bore enables to control constant intraocular pressure during Injection.

AA 4900 20 G

AA 4901 23 G

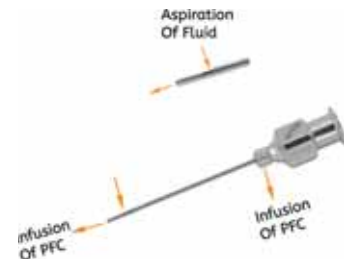

Dual Bore BSS injection Needle

0.1 mm/41 G tip

Enables to control subretinal injection of BSS.

dual bore cannula combined with aspiration capability

AA 4902 20 G



Viscous fluid injection cannula

5 Per box

Allows injection of viscous fluids such as silicone oil through 23 G Trocar cannula.

10 mm polyimide tip.

AA 4903 23 G



SUBRETINAL FLUID CANNULAS

Flexible sleeve allows atraumatic entry through retinal or macular tears or holes and enables aspiration of subretinal fluid.



Grizzard Subretinal fluid Cannula

Angled

AA 4927 20 G x 1 inch (.90 x 25 mm)

AA 4928 25 G x 5/32 inch (.30 x 4 mm) tip

6 mm tubing extension

tubing : D - 0.3 mm (0.012in), OD - 0.6 mm (0.025in)



Grizzard Subretinal fluid Cannula

Straight

AA 4931 20 G x 1 inch (.90 x 25 mm)

AA 4932 25 G x 5/32 inch (.30 x 4 mm) tip

6 mm tubing extension

tubing : D - 0.3 mm (0.012in), OD - 0.6 mm (0.025in)



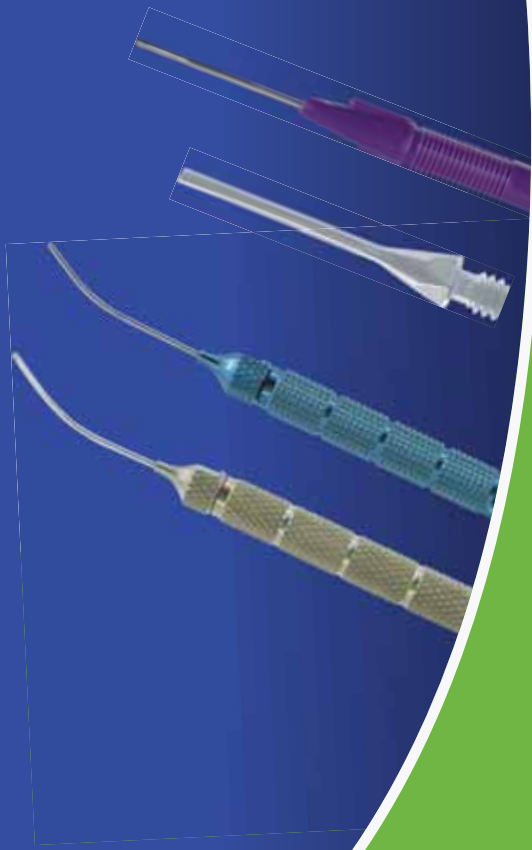

Sterilization Boxes

Phaco Tips

Bimanual I/A Handpiece

Coaxial I/A Handpiece

Irrigating Choppers



STERILIZATION BOXES

Stainless Steel Boxes

REF	Description	Dimensions in mm (L* W*H)	Dimensions in inches (L* W*H)	Spec.
AA8000	Sterilization Box with Silicone ribs for APPA BLADE	165 * 90 * 15	6 ½ * 3 ½ * 0.6	Small
AA8003	Sterilization Box with One Silicone mat	165 * 90 * 15	6 ½ * 3 ½ * 0.6	Small
AA8005	Sterilization Box with One Silicone mat	202 * 120 * 18	8 * 4 ¾ * ¾	Medium
AA8020	Sterilization Box with Two Silicone mats	240 * 200 * 18	9 ½ * 8 * ¾	Large
AA8030	Double layer Sterilization Box with Two Silicone mats	205 * 125 * 30	8 * 5 * 1 ¼	Medium with double layer
AA8220	Sterilization Box for Phaco Handpiece and accessories	230 * 155 * 60	9 * 6 * 2 ½	Large

PLASTIC BOXES

- High Performance Thermoplastic

REF #	Description	Dimensions in mm (L* W*H)	Dimensions in inches (L* W*H)	Spec.
AA8200	Sterilization Box with Silicone mat	245 * 147 * 25	9 ½ * 5¾ * 1	Large
AA8201	Sterilization Box with Silicone mat	198*108 * 20	8 * 4 ¼ * ¾	Medium
AA8202	Sterilization Box with Silicone mat	160 * 70 * 20	6 ¼ * 2¾ * ¾	Small
AA8203	Sterilization Box with Silicone mat	160 * 70 * 35	6 ¼ * 2¾ * 1 ½	Small with Height
AA8206	Sterilization Box with Silicone mat	78 * 45 * 20	3 * 1 ¾ * ¾	Extra Small
AA8207	Sterilization Box with Silicone mat	78 * 45 * 35	3 * 1 ¾ * 1 ½	Extra Small with Height
AA8215	Double layer Sterilization Box with 2 Silicone mats	245 * 147 * 45	9 ½ * 5¾ * 1 ¾	Extra Large
AA8221	Sterilization Box with Silicone ribs for Phaco Handpiece and accessories	245 * 147 * 45	9 ½ * 5¾ * 1 ¾	Extra Large

Appasamy Sterilization Box

Suitable for appa blade autoclave purpose with hinged lid

size:165 X 90 X 15mm

AA 8000



Appasamy Sterilization Box

Small box with hinged lid

a stainless steel sterilizing box designed to protect a set of ultra Fine micro surgical instruments during steam sterilization. size: 165 x 90 x 15 mm

AA 8003 complete



Appasamy Sterilization Box

Medium box with hinged lid

a stainless steel sterilizing box designed to protect a set of ultra Fine micro surgical instruments

size:202 X 120 X 18 mm

AA 8005 complete

AA 8015 silicone mat



Appasamy Sterilization Box

Large box with hinged lid

size: 240 x 200 x 18 mm

with 2 silicone mats

AA 8020 complete

AA 8015 silicone mat



Appasamy Sterilization Box

Medium box with hinged lid
size: 205 x 125 x 30 mm
with 2 silicone mats
AA 8030 double decker
AA 8015 silicone mat

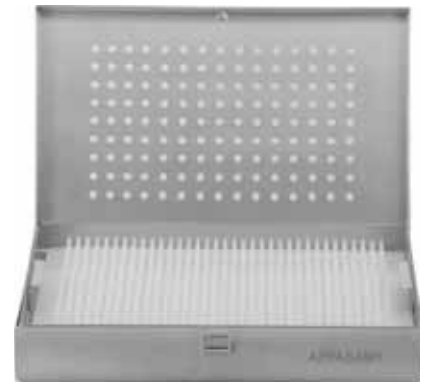

Appasamy See-Through Plastic Sterilization Box

This large box is made of a special thermoplastic which is designed to withstand repeated autoclaving cycles. The box can be used for steam sterilization and ETO sterilization methods. The soft silicone mat protect the instruments during sterilization, transport and storage. Lid and base of box and silicone mat are perforated with round holes for steam penetration and subsequent drainage. The transparent lid helps visualization during closure of the box. The instruments do not touch each other and also to make sure that the lid is not applying any pressure on to the tips of the instruments.

size: 245 x 146 x 25 mm
AA 8200 Complete
AA 8015 silicone mat
size: 240 x 140 x 15 mm

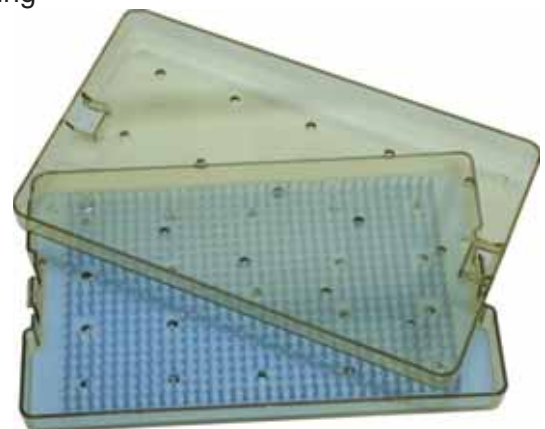

Appasamy See-Through Plastic Sterilization Box

Medium box
size: 198 x 108 x 20 mm
AA 8201



Appasamy See-Through Plastic Sterilization Box

Small box
size: 160 x 70 x 20 mm
AA 8202



Appasamy See-Through Plastic Sterilization Box

Small with height
size: 160 x 70 x 35 mm
AA 8203



Appasamy See-Through Plastic Sterilization Box

Extra small
size: 78 x 45 x 20 mm
AA 8206

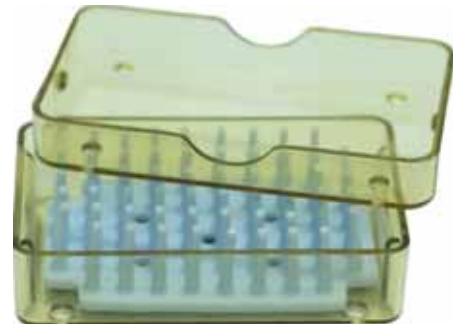

Appasamy See-Through Plastic Sterilization Box

Extra small with height
size: 78 x 45 x 35 mm
AA 8207

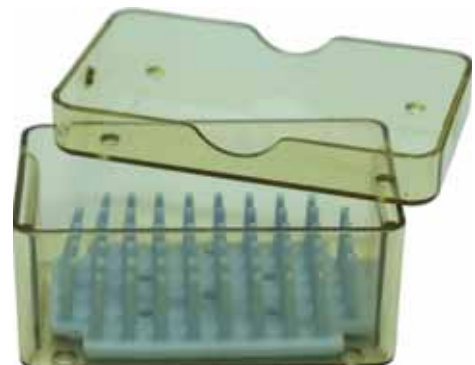

**Appasamy See-Through
Plastic Sterilization Box**
double decker, extra large
size: 245 x 147 x 45 mm
AA 8215

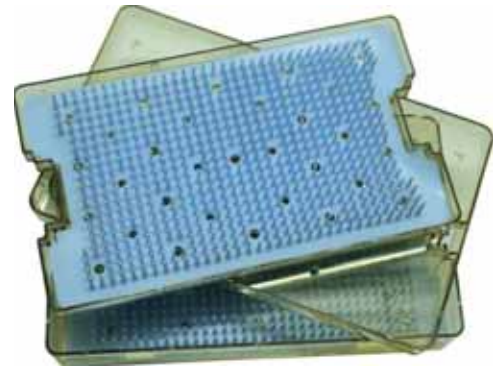

Appa Phaco Box
A stainless steel sterilization box
designed to protect
phaco handpiece during
sterilization, large
size: 230 X 155 X 60 mm
AA 8220



**Appasamy See-Through
Phaco Hand Piece Sterilization Box**
Extra large
size: 245 x 147 x 45 mm
AA 8221

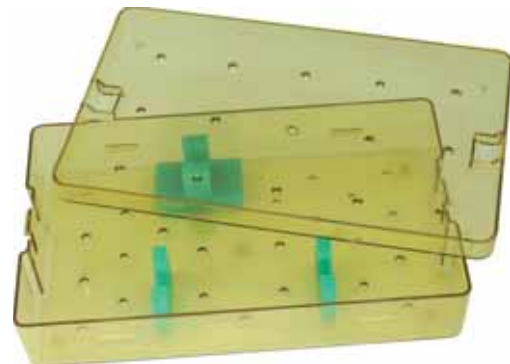

PHACO TIP OVERVIEW

PRODUCT NAME	GAUGE SIZE	AVAILABLE DEGREE	INCISION SIZE
CLASSIC - WITH GROOVE, 19 G	19G / 1.03mm	30° (Standard) 45°/15°/0°	2.8 mm
CLASSIC - WITHOUT GROOVE, 19 G	19G / 1.03 mm	30° (Standard) 45°/15°/0°	2.8 mm
HYPERSONIC-19 G	19G / 1.1 mm	30° (Standard) 45°/15°/0°	2.8 mm
CLASSIC-KELMAN-19 G	19G / 1.03 mm	30° (Standard) 45°/15°/0°	2.8 mm
MICROSONIC-KELMAN-20 G	20G / 0.9 mm	30° (Standard) 45°/15°/0°	2.5 mm
SUB SONIC-KELMAN-21 G	21G / 0.8 mm	30° (Standard) 45°/15°/0°	2.2 mm
SUB SONIC-WITHOUT GROOVE -21 G	21G / 0.8 mm	30° (Standard) 45°/15°/0°	2.2 mm
MICROSONIC-FRAGMATOME-20 G	20G / 0.9 mm	30° (Standard) 45°/15°/0°	2.5 mm
(FLARED) F-SONIC SQUARE-17 G	17G / 1.35 mm	30° (Standard) 45°/15°/0°	2.8 mm

BIMANUAL I/A INSTRUMENTS

#	GAUGE SIZE	INCISION SIZE	ASPIRATION PORT	IRRIGATION PORT
1	20G / 0.9 mm	2.8 mm	0.35 mm	0.50 mm
2	21G / 0.8 mm	2.2 mm	0.35 mm	0.50 mm
3	22G / 0.72 mm	2.2 mm	0.30 mm	0.35 mm
4	23G / 0.63 mm	1.8 mm	0.30 mm	0.35 mm

CO-AXIAL I/A INSTRUMENTS

#	GAUGE SIZE	INCISION SIZE	ASPIRATION CANNULA	ASPIRATION PORT	ASPIRATION HEAD
1	21G / 0.8 mm	2.8 mm	Straight Tip	0.3 mm Port	Metal sleeve tip
2	21G / 0.8 mm	2.8 mm	Curved Tip	0.3 mm port	Metal sleeve tip
3	21G / 0.8 mm	2.8 mm	Curved Tip with pin	0.3 mm port	Metal sleeve tip
4	21G / 0.8 mm	2.8 mm	45° Angle Tip	0.3 mm port	Metal sleeve tip
5	21G / 0.8 mm	2.8 mm	90° Angle Tip	0.3 mm port	Metal sleeve tip
6	21G / 0.8 mm	2.8 mm	90° Angle tip with pin	0.3 mm port	Metal sleeve tip
7	21G / 0.8 mm	2.8 mm	Binkhorst tip 150°	0.3 mm port	Metal sleeve tip
8	21G / 0.8 mm	2.8 mm	Binkhorst tip with pin 150°	0.3 mm port	Metal sleeve tip
9	19G / 1.05 mm	2.2 mm	Straight	0.3 mm port	silicone sleeve tip
10	19G / 1.05 mm	2.2 mm	45° angle	0.3 mm port	silicone sleeve tip

CLASSIC - WITH GROOVE, 19 G

- AAT 7415 0° (OD - 1.03mm)
- AAT 7415A 15° (OD - 1.03mm)
- AAT 7415B 30° (OD - 1.03mm)
- AAT 7415C 45° (OD - 1.03mm)



Phaco Wrench AA 7416



CLASSIC - WITHOUT GROOVE, 19 G

- AAT 7417 0° (OD - 1.03mm)
- AAT 7417A 15° (OD - 1.03mm)
- AAT 7417B 30° (OD - 1.03mm)
- AAT 7417C 45° (OD - 1.03mm)



HYPERSONIC-19 G

- AAT 7475 0° (OD - 1.1mm)
- AAT 7475A 15° (OD - 1.1mm)
- AAT 7475B 30° (OD - 1.1mm)
- AAT 7475C 45° (OD - 1.1mm)



CLASSIC-KELMAN-19 G

- AAT 7476 0° (OD - 1.03mm) 19G
- AAT 7476A 15° (OD - 1.03mm) 19G
- AAT 7476B 30° (OD - 1.03mm) 19G
- AAT 7476C 45° (OD - 1.03mm) 19G

SUB SONIC-KELMAN-21 G

- AAT 7476E 0° (OD - 0.8mm) 21G
- AAT 7476E 15° (OD - 0.8mm) 21G
- AAT 7476E 30° (OD - 0.8mm) 21G
- AAT 7476E 45° (OD - 0.8mm) 21G

MICROSONIC-KELMAN-20 G

- AAT 7476D 0° (OD - 0.9mm) 20G
- AAT 7476D 15° (OD - 0.9mm) 20G
- AAT 7476D 30° (OD - 0.9mm) 20G
- AAT 7476D 45° (OD - 0.9mm) 20G



SUB SONIC-WITHOUT GROOVE -21 G

- AAT 7477 0° (OD - 0.8mm)
- AAT 7477A 15° (OD - 0.8mm)
- AAT 7477B 30° (OD - 0.8mm)
- AAT 7477C 45° (OD - 0.8mm)



MICROSONIC-FRAGMATOME-20 G

- AAT 7478A 15° (OD - 0.9mm)
- AAT 7478B 30° (OD - 0.9mm)



(FLARED) F-SONIC SQAURE-17 G

- AAT 7479 30° (OD - 1.35mm)



Phaco Tip Sleeve
Incisions of 1.8 mm
AA 8500



Phaco Tip Sleeve
Incisions of 2.2 mm
AA 8505



Phaco Tip Sleeve
Incisions of 2.5 mm
AA 8510



Phaco Tip Sleeve
Incisions of 2.8 mm
AA 8515



Phaco Test Chamber
Made of high quality silicone rubber
compatible to all brands
AA 8520



Phaco Tubing
AA 8525



The phaco probe is an ultrasonic handpiece with a titanium or steel needle. The tip of the needle vibrates at ultrasonic frequency to sculpt and emulsify the cataract while the pump aspirates particles through the tip. In some techniques, a second fine steel instrument called a "chopper" is used from a side port to help with chopping the nucleus into smaller pieces. The cataract is usually broken into two or four pieces and each piece is emulsified and aspirated out with suction. The nucleus emulsification makes it easier to aspirate the particles. After removing all hard central lens nucleus with phacoemulsification, the softer outer lens cortex is removed with suction only.

Standard Handpiece (3/4")
With inner Irrigation
AA 9000



Slim model (1/2")
With Outer Irrigation
AA 9001



Orbital Phaco Handpiece
Having an outside diameter of 12 mm, an (35 grams) and completely made of Titanium with coaxial (irrigation and aspiration flow). The handpiece which is equipped with 6 piezo crystals.
AAT 9002



Fragmentome Handpiece
Having an outside diameter of 12 mm, an Internal infusion tube, being Light weight (35 grams) and completely made of Titanium (only aspiration flow). The handpiece which is equipped with 6 piezo crystals.
AAT 9003



AA - Stainless Steel, AAT - Titanium

Super Pinky Ball
For intraocular pressure reduction
AA 9020



Tenzel Bipolar forceps
Jeweler's type
pointed tip, straight
AA 9100 / AAD 9100



McPherson
Bipolar forceps
AA 9110 straight



McPherson
Bipolar forceps
AA 9120 curved



McPherson
Bipolar forceps
AA 9130 angled



Coaptation
Bipolar forceps
AA 9140 angled



Bipolar Forceps
for DCR surgery
AA 9145 straight



Bipolar Cord
Silicone,
Reusable
AA 9150



Bipolar Eraser
Autoclavable plastic

- AA 9160A** 0°, 18 G
- AA 9160** 15°, 18 G
- AA 9161** 30°, 18 G
- AA 9162** 45°, 18 G
- AA 9165A** 0°, 20 G
- AA 9165** 15°, 20 G
- AA 9166** 30°, 20 G
- AA 9167** 45°, 20 G
- AA 9168** 0°, 23 G
- AA 9168A** 15°, 23 G
- AA 9169** 30°, 23 G
- AA 9169A** 45°, 23 G
- AA 9169B** 0°, 25 G
- AA 9169C** 15°, 25 G
- AA 9169D** 30°, 25 G



Disposable Battery Cautery
Accessories and burners for
elemental cautery
AA 9180
AA 9180A tip only



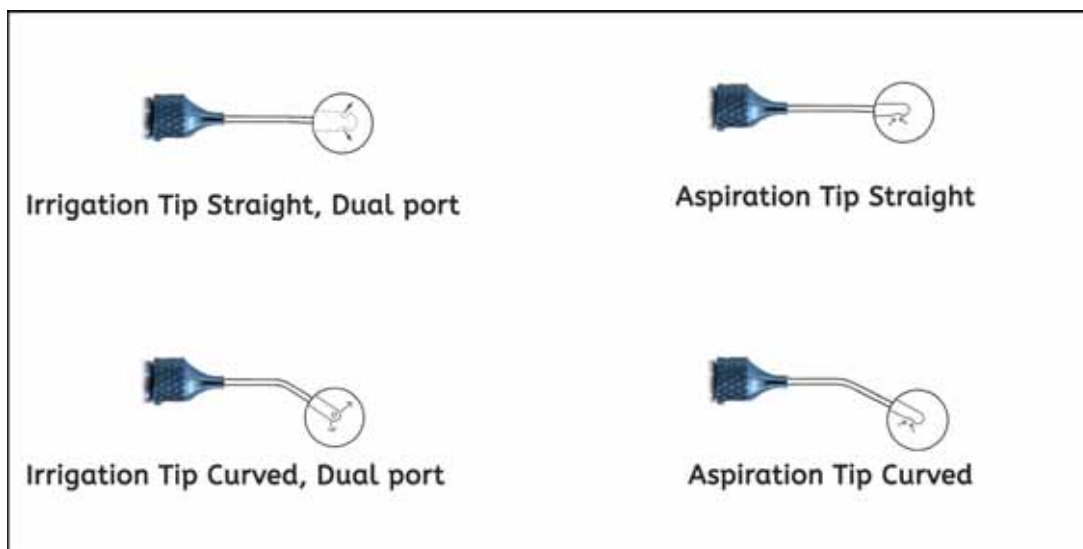

- Tip Interchangeable
- Light Weight
- Designed for use in either side port
- Autoclavable
- Irrigation Handpiece - Gold colour
- Aspiration Handpiece - Blue colour

- **APPASAMY** Bimanual I/A Handpiece are for bimanual irrigation and aspiration of residual cortex after phacoemulsification and removal of the nucleus.
- For **SUBINCISIONAL CORTEX**, the side port irrigation / aspiration system eliminates difficulties of access and provides superior chamber maintenance.
- For **SMALL PUPILS**, the irrigation handpiece can retract the Iris for better visualization during aspiration.
- For **DENSE NUCLEUS**, the irrigation cannula can crush nuclear chips and epi nuclear material into the port of the aspiration cannula.
- For **HIGHLY RETENTIVE VISCOELASTIC**, the irrigation cannula can wash the viscoelastic from behind the IOL before aspiration.
- For **POSTERIOR CAPSULE**, the textured surface of the cannula may be used to polish the posterior capsule.

20 Gauge

AAT 7412	20G Aspiration 0.5mm Port
AAT 7436 A	20G Aspiration Sand Blasted
AAT 7412 A	20G Aspiration Conical Tip
AAT 7412 B	20G Aspiration Front Open
AAT 7432	20G Irrigation 0.50mm Port
AAT 7437 A	20G Irrigation Sand Blasted
AAT 7432 A	20G Irrigation Conical Tip
AAT 7432 B	20G Irrigation Front Open
AAT 7432 C	20G Irrigation Dual Over Ports 0.3mmx0.4mm

21 Gauge

AAT 7413	21G Aspiration 0.5mm Port
AAT 7436 B	21G Aspiration Sand Blasted
AAT 7413 B	21G Aspiration Conical Tip
AAT 7413 C	21G Aspiration Front Open
AAT 7433	21G Irrigation 0.50mm Port
AAT 7437 B	21G Irrigation Sand Blasted
AAT 7433 B	21G Irrigation Conical Tip
AAT 7433 C	21G Irrigation Front Open
AAT 7433 D	21G Irrigation Dual Over Ports 0.3mmx0.4mm

22 Gauge

AAT 7413 A	22G Aspiration 0.3mm Port
AAT 7436 D	22G Aspiration Sand Blasted
AAT 7413 E	22G Aspiration Conical Tip
AAT 7413 F	22G Aspiration Front Open
AAT 7433 A	22G Irrigation 0.5mm Port
AAT 7437 D	22G Irrigation Sand Blasted
AAT 7433 E	22G Irrigation Conical Tip
AAT 7433 F	22G Irrigation Front Open
AAT 7433 G	22G Irrigation Dual Over Ports 0.3mmx0.4mm

23 Gauge

AAT 7414	23G Aspiration 0.3mm Port
AAT 7436 C	23G Aspiration Sand Blasted
AAT 7414 A	23G Aspiration Conical Tip
AAT 7414 B	23G Aspiration Front Open
AAT 7434	23G Irrigation 0.3mm Port
AAT 7437 C	23G Irrigation Sand Blasted
AAT 7434 A	23G Irrigation Conical Tip
AAT 7434 B	23G Irrigation Front Open
AAT 7434 C	23G Irrigation Dual Over Ports 0.3mmx0.4mm

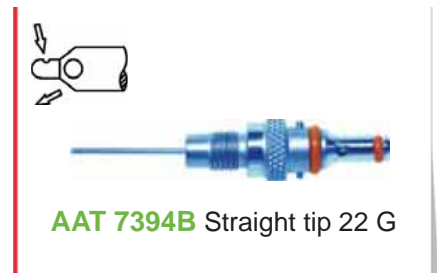
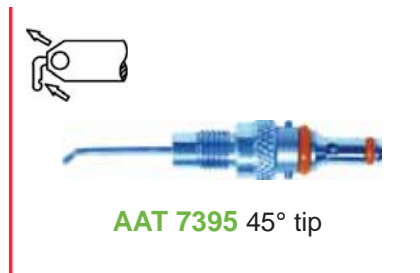
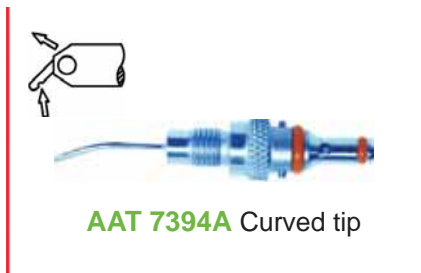
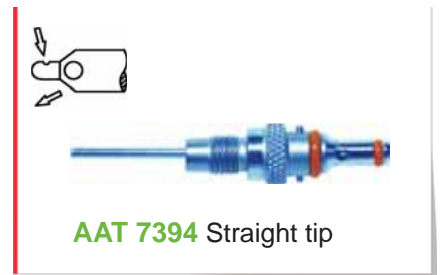
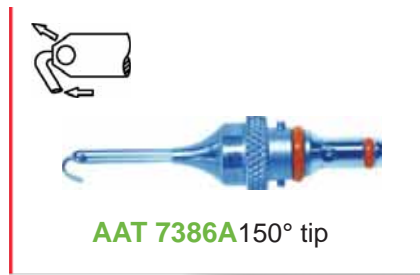
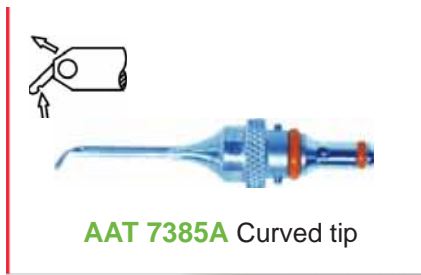
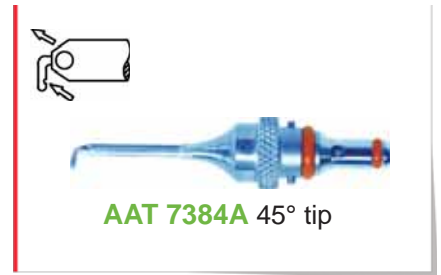

LIGHT WEIGHT - BALANCED RAPID TIP INTERCHANGEABLE

I/A tip

S-curved polished
 it's complete cleaning capability helps to avoid possible contamination
 compatible to all popular phaco consoles. Fits multiples sleeves.
 All titanium, universal fitting allows one to use this handle with various I/A tips.

- AAT 7398** straight
- AAT 7398A** curved
- AAT 7398B** cobra curved



AAT 7382A Straight tip with pin: 0.3 mm aspiration port. Used for initial cortical extraction.

16 G irrigation cannula.

AAT 7383A Curved tip with pin: 0.3 mm aspiration port. Used for initial cortical extraction.

16 G irrigation cannula.

AAT 7384A 45° angle tip with pin: 0.3 mm aspiration port. Used for peripheral cortical extraction

16 G irrigation cannula.

AAT 7385A 90° angle tip: 0.3 mm aspiration port. Used for peripheral cortical extraction

16 G irrigation cannula.

AAT 7386A Binkhorst tip with pin: 150° return. 0.3 mm open end. Used for cortical extraction.

At 12 O' clock. Return is designed for a 3 mm wound insertion. 16 G irrigation cannula.

AAT 7393 Round handle for with pin tip.

AAT 7394 Straight silicone sleeve tip 0.3 mm aspiration port. 19 G aspiration cannula.

AAT 7394A Curved silicone sleeve tip 0.3 mm aspiration port. 19 G aspiration cannula.

AAT 7395 45° angle silicone sleeve tip 0.3 mm aspiration port. 19 G aspiration cannula.

AA 7396 Replacement 'O' ring set. (5 sets per box).

AAT 7394B Straight silicone sleeve tip 0.3mm aspiration port 22 G aspiration cannula

ELITE TURBO IRRIGATING CHOPPERS

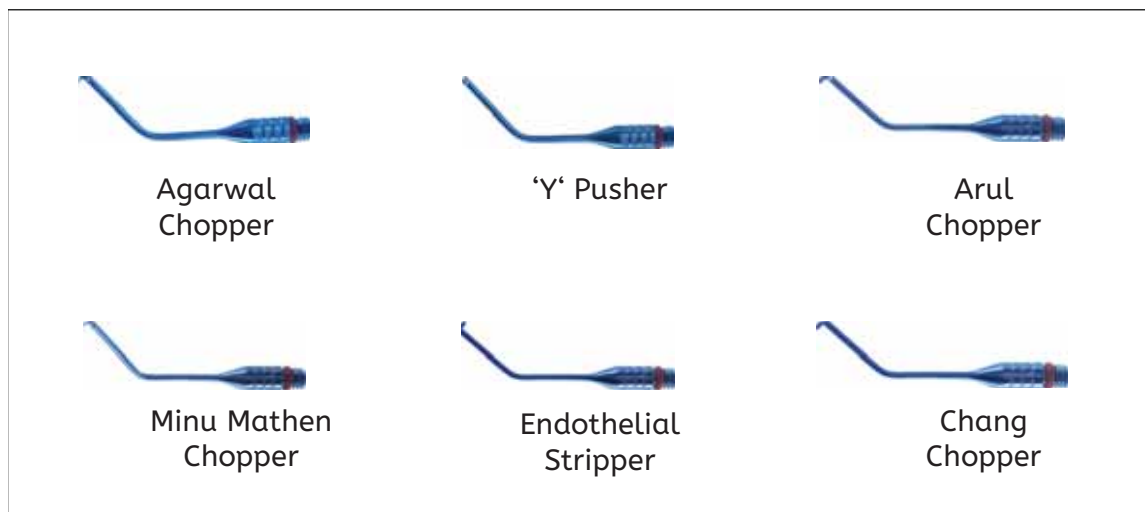

- AAT 8300** Agarwal turbo irrigating chopper sharp edge 20 gauge tip angled 90° set
- AAT 8301** Agarwal turbo irrigating chopper sharp edge 20 gauge tip angled 90° tip only
- AAT 8302** Agarwal turbo irrigating chopper sharp edge 20 gauge tip angled 110° set
- AAT 8303** Agarwal turbo irrigating chopper sharp edge 20 gauge tip angled 110° set only
- AAT 8305** Arul turbo irrigating chopper 20 gauge tip set
- AAT 8306** Arul turbo irrigating chopper 20 gauge tip only
- AAT 8310** Chang irrigating chopper 20 gauge tip set
- AAT 8311** Chang irrigating chopper 20 gauge tip only
- AAT 8315** Minu mathen irrigating chopper 20 gauge tip set
- AAT 8316** Minu mathen irrigating chopper 20 gauge tip only
- AAT 8320** Irrigating 'y' pusher 20 gauge tip set
- AAT 8321** Irrigating 'y' pusher 20 gauge tip only
- AAT 8325** Irrigating endothelial stripper 20 gauge tip set
- AAT 8326** Irrigating endothelial stripper 20 gauge tip only
- AAT 8350** Elite irrigating chopper set
- AAT 8410** Irrigating chopper aspirating handle
- AAT 8411** Irrigating chopper irrigating handle
- AAT 8420** Turbo irrigating seibel chopper
- AAT 8421** Turbo irrigating nagahara chopper



DISPOSABLE INSTRUMENTS

Speculums

Probing Needles

Forceps

Cannula

Bimanual I/A Handpiece

Co-axial I/A Probe Handpiece

Vitreo Retinal Instruments



AAD 1009

Barraquer Wire Speculum, Large

Pack
10

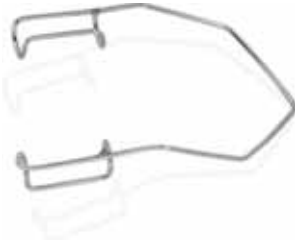

- Closed lid
- 0.9mm wire
- 14mm blade length
- Stainless steel
- Temporal approach

AAD 1016

Barraquer Wire Speculum with Solid Blade, Large

Pack
10



- 13mm Blade length
- Overall length - 42mm
- 0.9mm wire
- Stainless Steel wire
- Polymer lid
- Temporal approach

AAD 1025

Kratz-Barraquer Wire Speculum, Large

Pack
10



- Open blades for Phaco surgery
- 14mm Blade length
- 0.9mm wire
- Stainless Steel
- Temporal approach

AAD 1183 / 84

Lieberman - Tennant Eye Speculum

Pack
10

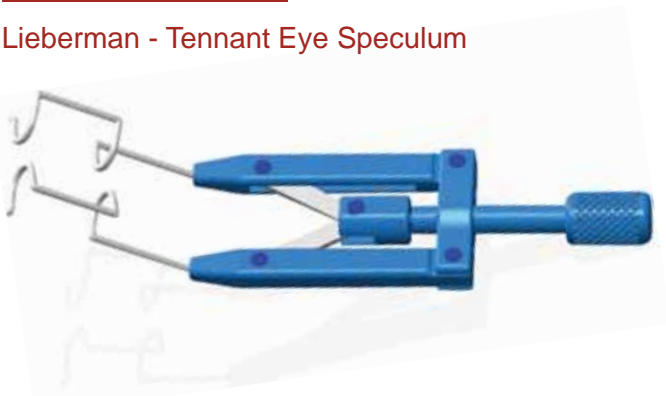

- Fenestrated, Open Blades
- Nasal Speculum AAD 1183
- Temporal Speculum AAD 1184



AAD 1465

Sinsky Lens Manipulating Hook



- Blunt tip, 0.7mm length, 0.2mm diameter
- 45° angled, 11mm bend Length
- For lens dialing and manipulation

Pack
10

AAD 1565

Lester No Hole Lens Manipulator



- 0.25 mm dia tip , hourglass shaped tip
- 45° angled, 11mm bend length
- For IOL Manipulation

Pack
10

AAD 1590

Bechert Nucleus Rotator



- Blunt forked tip
- 45° angled, 7mm bend length
- Tip width 0.7mm

Pack
10

AAD 1625

Maloney 'Y' Pusher & Rod



- Blunt forked tip
- Double ended
- For manipulating hard and soft nucleus

Pack
10

AAD 1626

Chang Quick Chop Combo



- Micro finger tip for Chopping & dividing the nucleus
- Quick chop tip for split the nucleus

Pack
10

AAD 1655

Barraquer Iris Spatula



- 60° Angled and vaulted
- 13 mm bend length
- Tip width 0.25mm dia.

Pack
10

AAD 1989

Mohan Rajan Micro Combo Chopper



- Pointed tips vertical
- 1.00mm tip
- Angled to tip 10 mm

Pack
10

AAD 1991

Arul Phaco Chopper



- 1.0mm inner cutting edge
- 0.25mm blunt polished tip
- Angled to tip 10 mm

Pack
10

AAD 1993

Agarwal Phaco Chopper



- 1.0 mm fully cutting edge sharp tip
- Angled to tip 11mm

Pack
10

AAD 2000

Nagahara Karate Chopper



- 1.5 mm tip
- Spear shaped
- Angled to tip 10 mm

Pack
10

AAD 2400

LASEK Hockey Knife



- Used to detach epithelium from the incision by the sharp anterior part of the knife
- Reposit the epithelium after ablation by the blunt part of the knife

Pack
10

AAD 2515

DSEK Reverse Sinskey Hook



- Blunt tip, 0.2 mm dia
- Angled reverse tip
- For lens dialing and manipulation

Pack
10



AAD 3090

Pierse Micro Forceps

Pack
10



- 0.25mm dia drill
- Overall length - 105 mm
- Straight 5mm platform

AAD 3145

Lims Corneoscleral Forceps

Pack
10



- Corneoscleral forceps with tying platform
- 1 x 2 teeth, 0.12mm
- Overall length 105 mm

AAD 3170

Bonn Corneal Forceps

Pack
10



- 5mm tying platform
- 1 x 2 teeth, 0.12mm
- Overall length 105 mm

AAD 3755

Jaffe Tying Forceps

Pack
10



- Suture tying forceps suitable for 8/0, 10/0 suture
- Smooth jaws, 5mm long platform
- Curved , overall length -105mm

AAD 3790

McPherson Tying Forceps

Pack
10



- Suture tying forceps suitable for 8/0, 10/0 suture
- Smooth jaws, 5mm long platform
- Straight, overall length -105mm

AAD 3805

McPherson IOL Forceps



- Smooth jaws, 11mm long
- Ideal for implanting IOLs
- Overall length 105 mm

Pack
10

AAD 3855

Utrata Capsulorhexis Forceps



- Very delicate grasping tips
- Extremely thin 11mm
- Long straight shanks
- Flat handle
- 1.2mm Incision

Pack
10

AAD 3868

Utrata Capsulorhexis Forceps



- Very delicate grasping tips
- Extremely thin 11mm
- Long straight shanks
- Round handle
- 0.9mm Incision

Pack
10

AAD 3869

Masket Capsulorhexis Forceps



- Very delicate grasping tips
- Extremely thin 11mm
- Long curved vaulted shanks
- Flat handle
- 1.2mm Incision

Pack
10

AAD 3870

Masket Capsulorhexis Forceps



- Very delicate grasping tips
- Extremely thin 11mm
- Long curved vaulted shanks
- Flat handle
- 1.2mm Incision

Pack
10

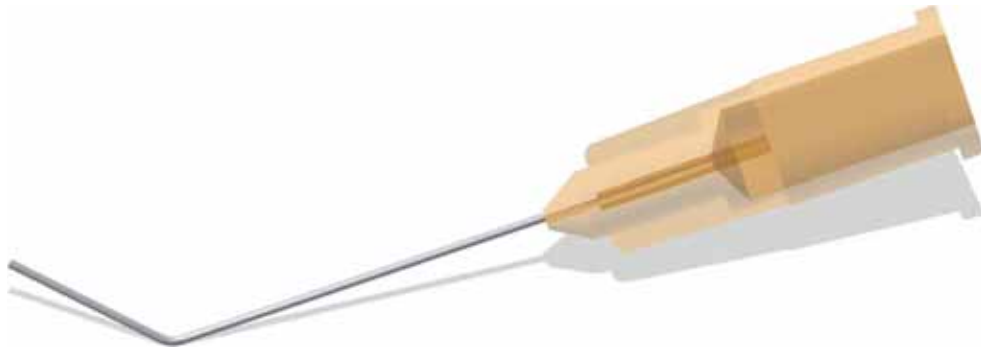

AAD 7105

Pack
10

Rycroft

Air injection cannula
lacrimal cannula 45° angled
5mm angled tip
overall length 22mm

AAD 7105

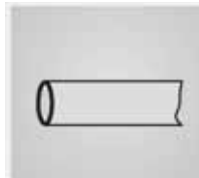

Available Gauges : 16 G, 18 G, 19 G, 20 G, 21 G, 22 G, 23 G, 24 G, 25 G, 26 G, 27 G, 30 G

AAD 7150

Pack
10

Lewicky

Anterior chamber maintainer cannula
20 G x 3.50 mm cannula
overall length 12 mm
The self-retaining threaded tip assures stable
fixation within the corneal stroma.

Cannula is connected with
200 mm long silicone tubing and adaptor

AAD 7150

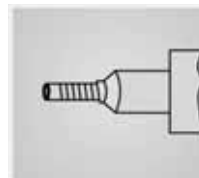

AAD 7205

Pack
10

Pearce

Hydrodissection cannula
35° angled
8mm flat blunt tip
overall length 22mm

AAD 7205 25 G



AAD 7230

Pack
10

Kellan

Hydrodelineation cannula
curved bevel tip
sharp on top
smooth on bottom

AAD 7230 25G

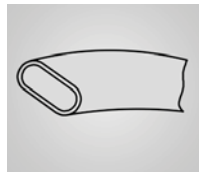

AAD 7295

Pack
10

Akahoshi

Hydrodelineation cannula
tapered tip design can be
easily inserted beneath the
capsulorhexis edge

AAD 7295 27 G

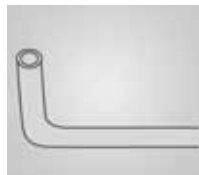

AAD 7420

Pack
10

Simcoe

Irrigating / Aspirating Cannula
Original model(Direct)
aspiration through main hub
curved shaft, overall length 16 mm
0.30 mm aspiration port

AAD 7418 21 G

AAD 7419 22 G

AAD 7420 23 G



AAD 7536

Pack
10

Cystotome
Irrigating Cystotome
formed, angled
AAD 7536 27 G

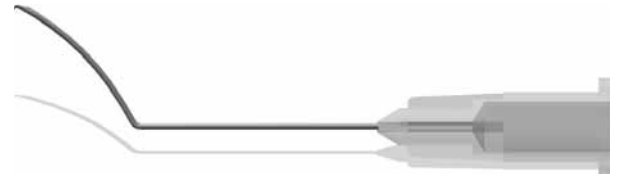

AAD 7666

Pack
10

Pearce
Hydrodissection Cannula
flat beveled tip 90° angled
AAD 7666 27 G

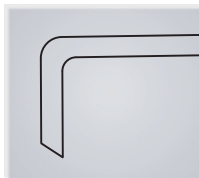

AAD 7705

Pack
10

Knolle-Pearce
Irrigating vectis
ports on outer side
23 G
overall length 38mm
4mm wide, 7mm long loop
AAD 7705

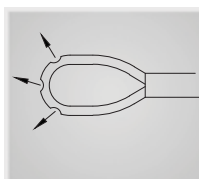

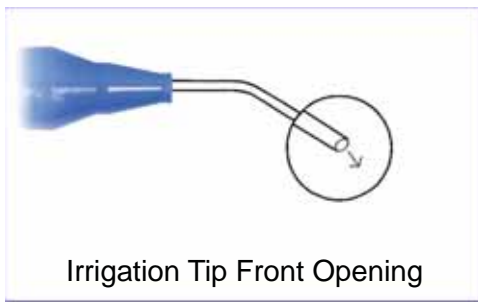

Irrigation Tip Front Opening

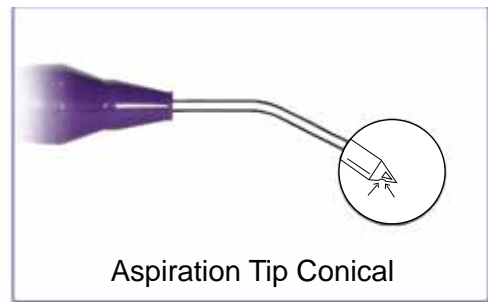

Aspiration Tip Conical

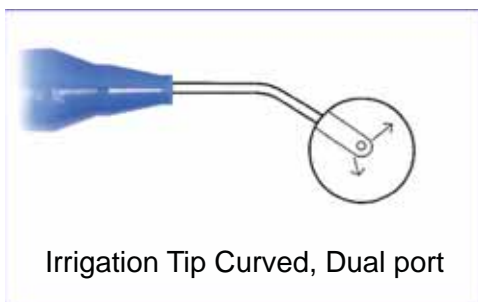

Irrigation Tip Curved, Dual port

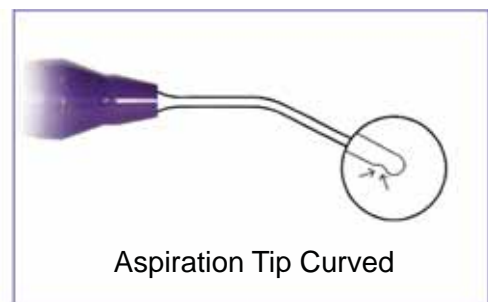

Aspiration Tip Curved

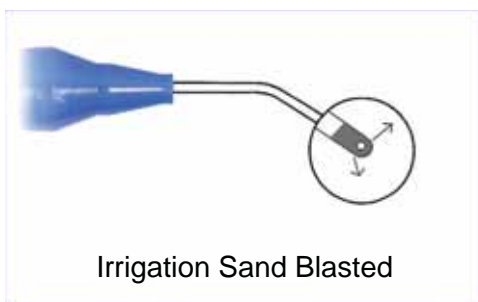

Irrigation Sand Blasted

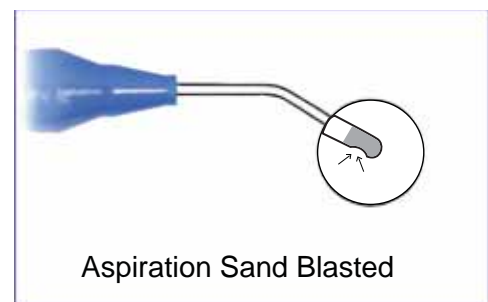

Aspiration Sand Blasted

AAD 7410/11

Bimanual I/A Handpiece
20 G / 21 G



AAD 7410/11

Bimanual I/A Handpiece
21 G / 22 G



AAD 7410/11

Bimanual I/A Handpiece
22 G / 23 G



AAD 7410/11

Bimanual I/A Handpiece
22 G / 22 G



AAD 7410/11

Bimanual I/A Handpiece
23 G / 23 G



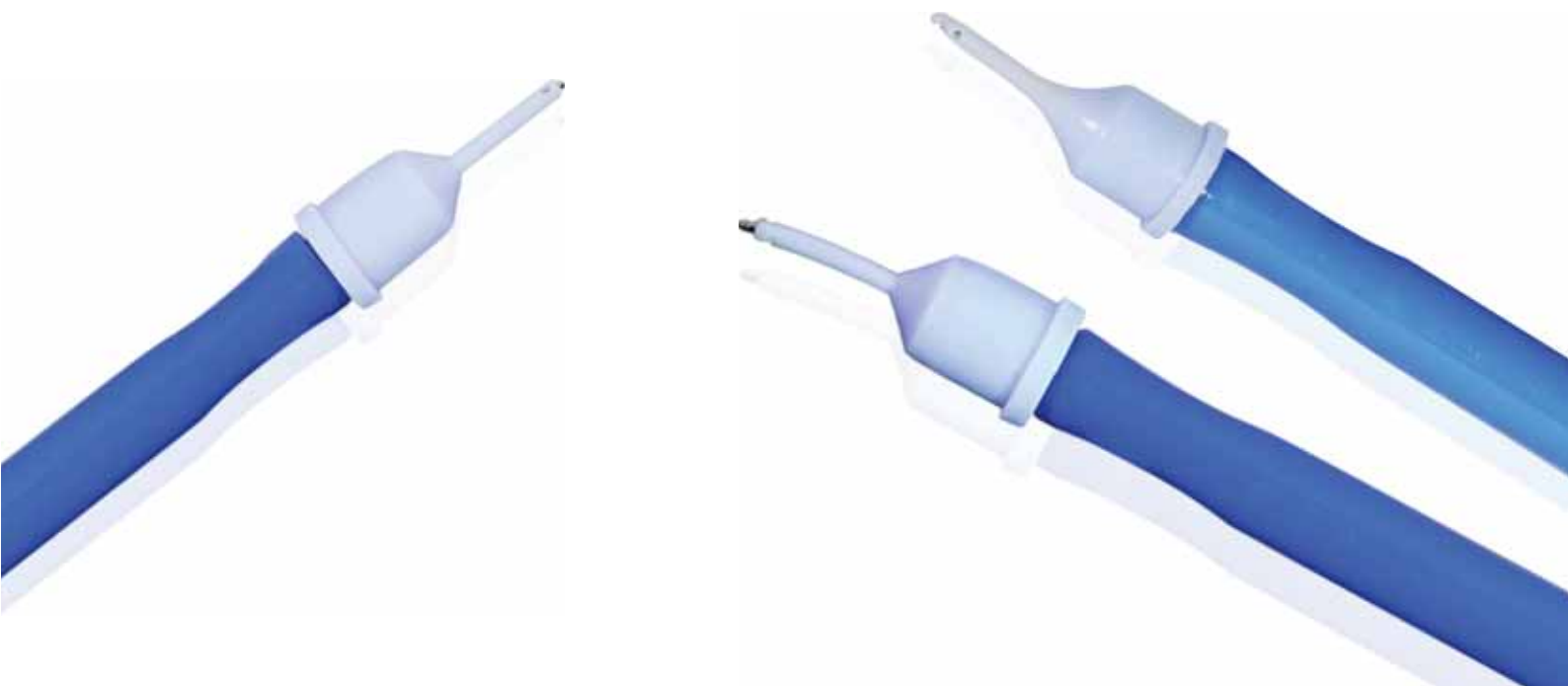

AAD 7382

I/A Handpiece Straight

Pack
10



- Straight tip for initial cortical removal
- 0.3 mm aspiration port
- Outer diameter 1.5mm(17 G)

AAD 7383

I/A Handpiece Curved

Pack
10



- Curved shaft
- Ideal for deep-set eyes
- 0.3 mm aspiration port
- Outer diameter 1.5mm(17 G)

AAD 7384

I/A Handpiece 45° angled

Pack
10



- For optimal 360. cortical material removal
- 0.3 mm aspiration port
- Outer diameter 1.5mm(17 G)



AAD 7399

I/A Handpiece closed sleeve, straight

Pack
10



- Straight tip with closed sleeve
- 0.3 mm aspiration port
- Outer diameter 1.5mm(17GA)

AAD 7399A

I/A Handpiece closed sleeve 45° angled

Pack
10



- Angled with closed sleeve
- Ideal for deep-set eyes
- 0.3 mm aspiration port
- Outer diameter 1.5mm(17GA)



Forceps

Forceps Smooth Jaws,
Straight
AAD 3960 20 G
AAD 3960A 23 G

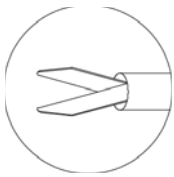

Forceps Serrated
Jaws, Straight
AAD 3965 20 G
AAD 3965A 23 G

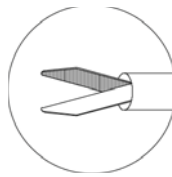

Forceps Smooth Jaws,
1x2 teeth Straight
AAD 3970 20 G
AAD 3970A 23 G

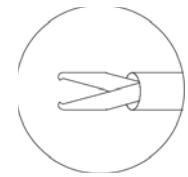

Forceps Smooth Jaws, 0.3mm
Platform Straight
AAD 3975 20 G
AAD 3975A 23 G

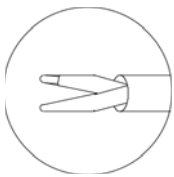

Forceps Smooth Jaws,
Vertical
AAD 3980 20 G
AAD 3980A 23 G

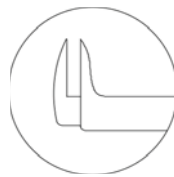

Agarwal
Glued IOL Forceps
Straight
AAD 3995 20 G
AAD 3995A 23 G

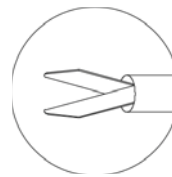

Agarwal
Glued IOL Forceps
Curved
AAD 3996 20 G
AAD 3996 A 23 G



Kreshner Micro
Incision Capsulorhexis
Forceps, Curved
AAD 3871 20 G
AAD 3871A 21 G

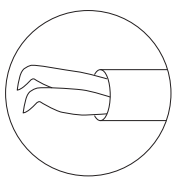

Kreshner Micro
Incision Capsulorhexis
Forceps, Curved
AAD 3872 23 G
AAD 3872A 23 G

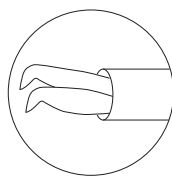

ILM Forceps
AAD 3986 20 G
AAD 3986A 23 G

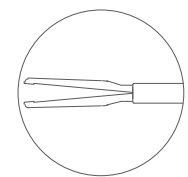

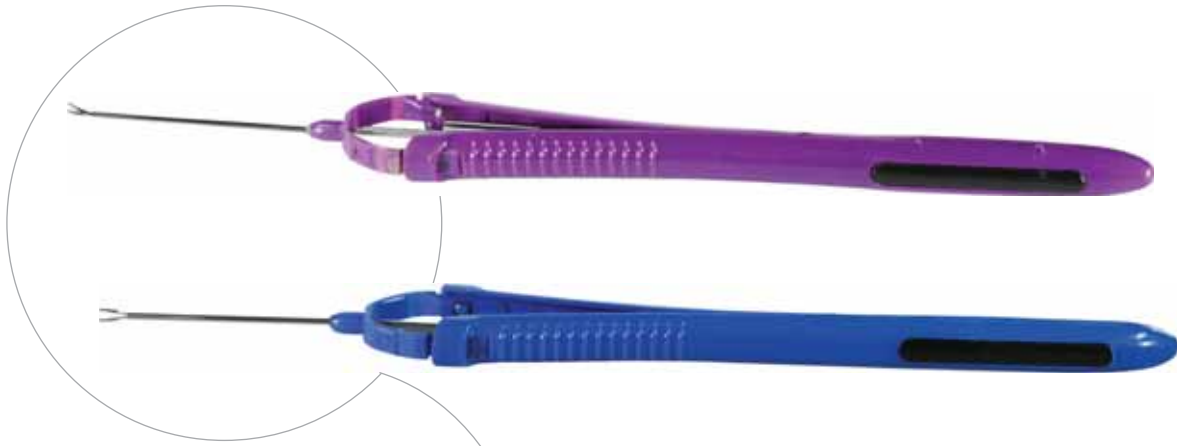

Scissors

Scissors Straight jaws
AAD 4450 20 G
AAD 4450A 23 G

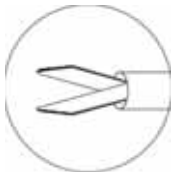

Scissors Angled jaws 30°
AAD 4460 20 G
AAD 4460A 23 G

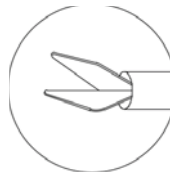

Scissors vertical cut 60°
AAD 4470 20 G
AAD 4470A 23 G

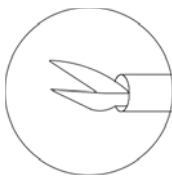

Scissors vertical cut 90°
AAD 4480 20 G
AAD 4480A 23 G

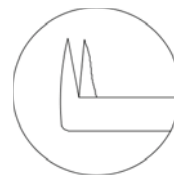

TROCAR CANNULA SYSTEM

Disposable one step trocar system

Flat stiletto knife for smooth incision
 unique closure valve system
 proximal end with 3.0 mm and 4.0 mm
 scleral marker
 each pack includes:
 trocar knife with preloaded trocar cannula - 4
 pre loaded trocar cannula plug - 4
 infusion line - 1
 sterile

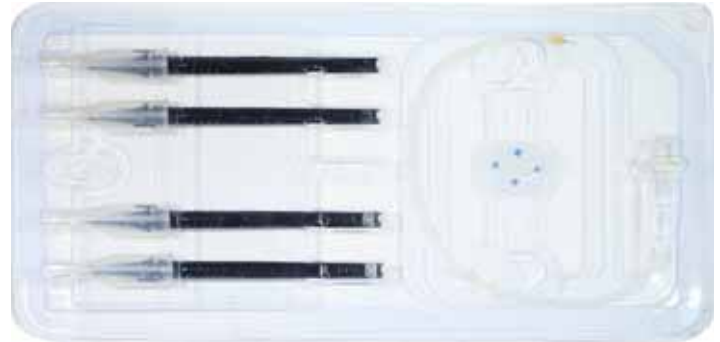

NON-VALVED TROCAR CANNULA SYSTEM

Trocar Cannula Plug



Trocar Plug Cap



AAD 7939 23 G
AAD 7939 A 25 G
AAD 7939 B 27 G

AAD 7936 23 G



AAD 7936 A 25 G



AAD 7936 B 27 G



VALVED TROCAR CANNULA SYSTEM



AAD 7941 23 G



AAD 7941 A 25 G



AAD 7941 B 27 G



Valved Trocar Cannula Plug

Trocar Infusion Cannula

Packaged sterile
AAD 7965 23 G
AAD 7966 25 G
AAD 7967 27 G



Vitreotomy Cutter

Disposable,
Sterile single use

AAD 7900 20G

AAD 7901 23G

AAD 7902 25G

0.9 mm

0.63 mm

0.5 mm

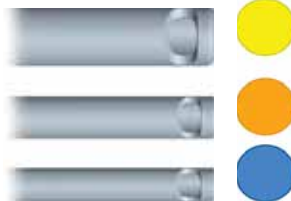

Fiber Optic Probes



Endo Illumination Probe, Focus

AAD 9170 20G

AAD 9173 23G

AAD 9175 25G

AAD 9177 27G

Focus

A= 12.5
(at 10mm distance)
angle = 62°

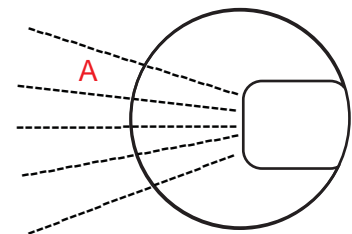

Endo Illumination Probe, wide Angle

AAD 9170 A 20G

AAD 9173 A 23G

AAD 9175 A 25G

AAD 9177 A 27G

Wide angle

A= 9mm
B=46mm
(at 10mm distance)
angle = 134°

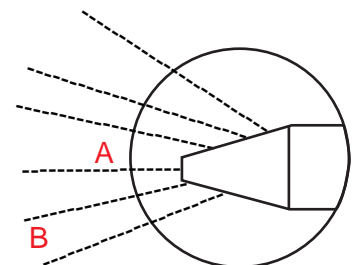

Endo Illumination Probe, Chandelier

AAD 9170 B 20G

AAD 9173 B 23G

AAD 9175 B 25G

AAD 9177 B 27G

Shielded

A= 9mm
B=25mm
(at 10mm distance)
angle = 102°

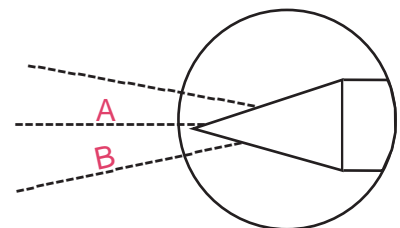

Microsurgery Cataract & IOL Set.....	214	Microsurgery Enucleation Set.....	232
Microsurgery Cataract Set (Compact).....	215	Femtosecond Cataract Set.....	233
Microsurgery IOL Set (Compact).....	216	Endothelial Set (DSAEK Set).....	234
Extracapsular Cataract Extraction (ECCE) Set.....	217	Deep Anterior Lamellar Keratoplasty (DALK) Set.....	235
Microsurgery Small Incision Non-Phaco Set.....	218	DMEK Set.....	236
Microsurgery ECCE-Phaco Emulsification Set.....	219	Implantable Contact Lens Set (ICL).....	237
Intracapsular Cataract Extraction (ICCE) Set.....	220	LASIK Retreatment Set.....	238
Microsurgery Glaucoma Set.....	221	Limbal Relaxation Incision (LRI) Set.....	239
Microsurgery Corneal Transplant Set.....	222	Phakic Lens Set.....	240
Microsurgery LASIK Set.....	223	Femtosecond LASIK Set.....	241
Microsurgery Lid Set.....	224	Intra Corneal Stromal Ring (ICSR) Set.....	242
Microsurgery Chalazion Set.....	225	Toric IOL Set.....	243
Microsurgery Muscle Set.....	226	Minor Surgery Set.....	244
Microsurgery Pterygium Set.....	227	Phaco 1.8mm - Bimanual (MICS) Set.....	245
Microsurgery Lacrimal (DCR) Set.....	228	Phaco 2.2mm-Comics Prechop Set.....	246
Vitreo-Retinal Posterior Segment Set.....	229	Phaco 2.8mm-Cataract Clear Corneal Set.....	247
Microsurgery Retina Set.....	230	Manual Phaco Fracture Cataract Extraction (MSICS) Set.....	248
Foreign Body Removal Set.....	231		

Stainless Steel Surgery Sets

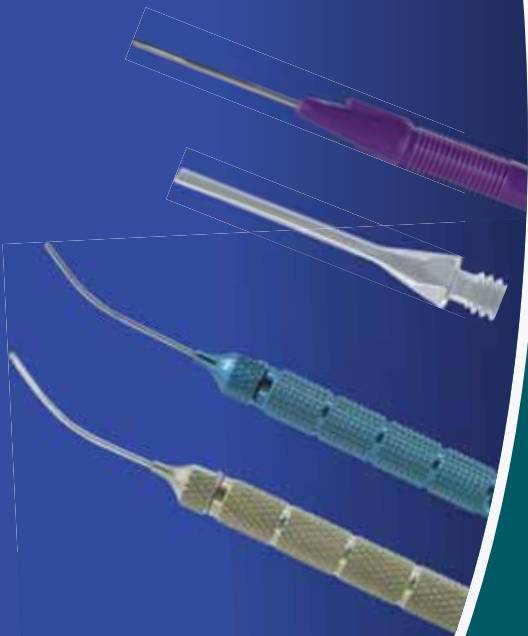

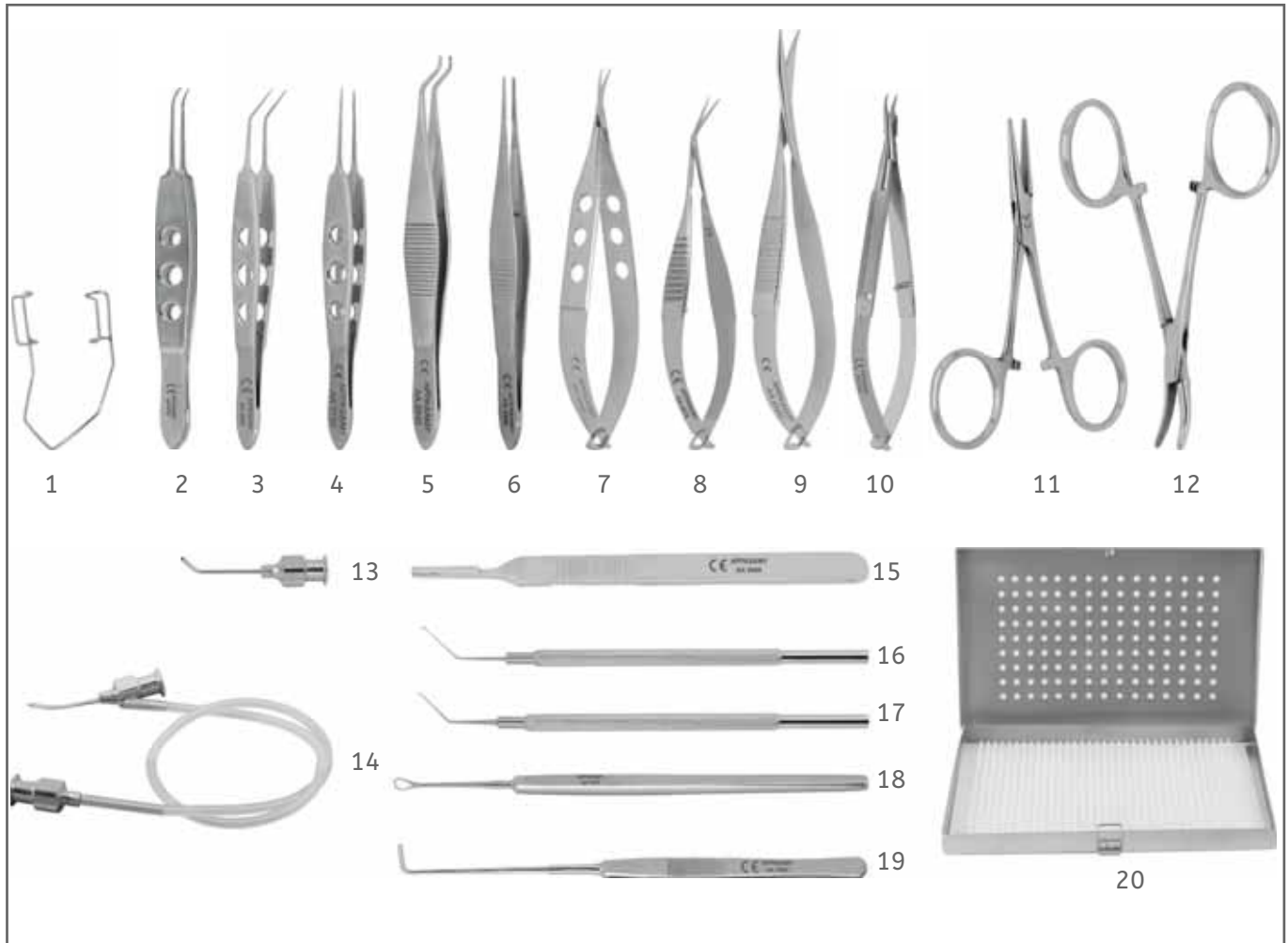

1. **AA 1009** Barraquer wire speculum, large
2. **AA 3755** Jaffe tying forceps smooth jaws with 5mm long platform curved
3. **AA 3805** McPherson IOL forceps, 11mm angled
4. **AA 3150** McPherson corneal forceps, 0.4mm, 1 x 2 teeth
5. **AA 3340** Dastoor superior rectus forceps, 1 x 2 teeth
6. **AA 3460** Wills hospital utility forceps
7. **AA 4040** Castroviejo corneal scissors small blades
8. **AA 4275** Vannas capsulotomy scissors, 11mm angled
9. **AA 4180** Westcott stitch scissors
10. **AA 5145** Barraquer N.Holder short model micro jaws, without lock
11. **AA 3920** Hartman mosquito forceps straight
12. **AA 3925** Hartman mosquito forceps curved
13. **AA 7105** Rycroft air injection cannula, 23 G
14. **AA 7420** Simcoe I/A cannula 23 G direct
15. **AA 5460** Bard-Parker handle #3 flat
16. **AA 1993** Agarwal phaco chopper 1mm fully cutting edge
17. **AA 1465** Sinskey II lens manipulating hook angled
18. **AA 1915** Lewis lens loop, small
19. **AA 1860** Smith lens Expressor
20. **AA 8005** Sterilization box with silicone mat

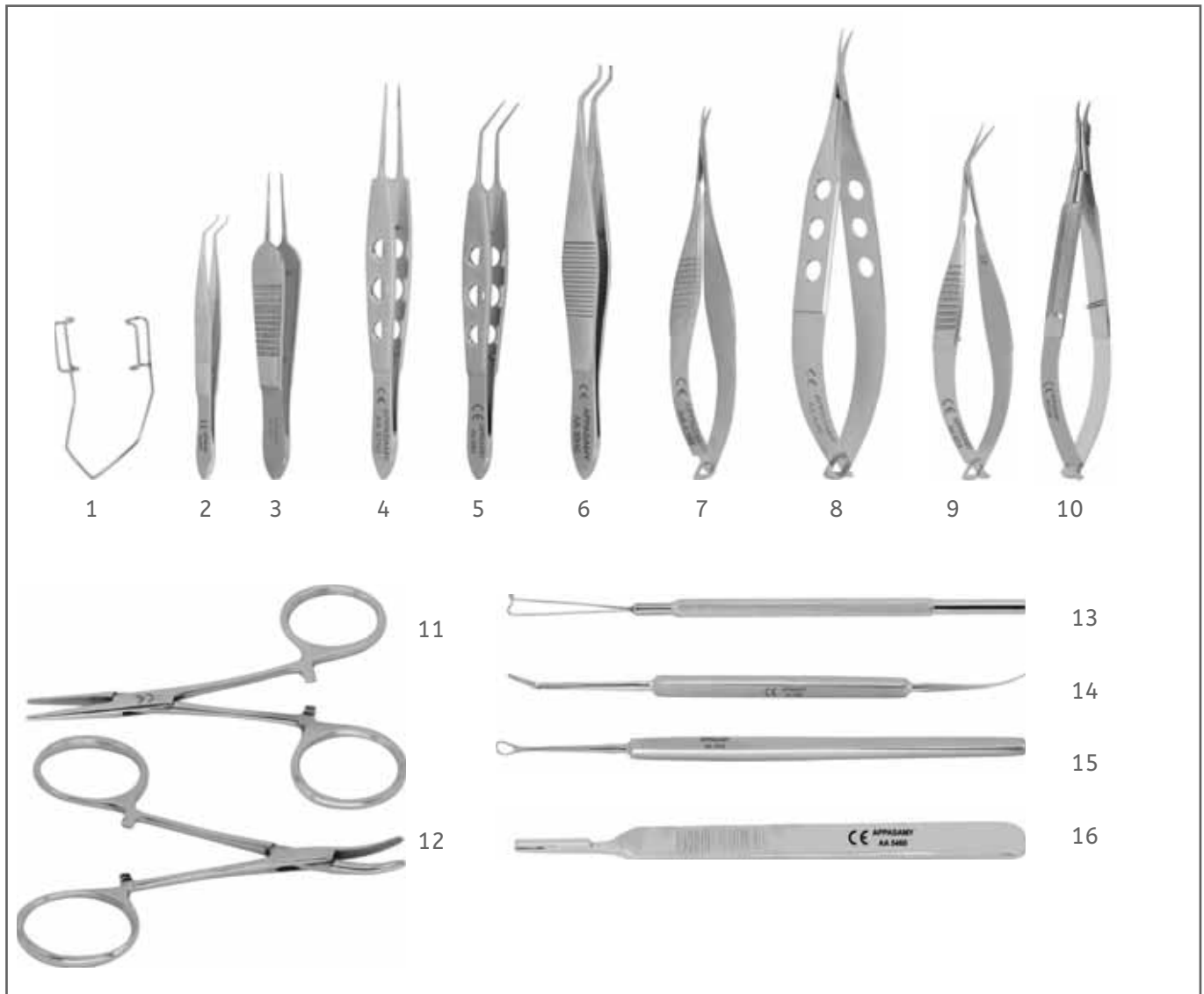

1. **AA 1009** Barraquer wire speculum, large
2. **AA 3025** Hess Iris forceps 1 x 2 teeth standard model
3. **AA 3275** St.Martin suturing forceps, 1 x 2 teeth
4. **AA 3750** Jaffe tying forceps smooth jaws with 5mm long platform straight
5. **AA 3805** McPherson IOL forceps, 11mm angled
6. **AA 3340** Dastoor superior rectus forceps, 1 x 2 teeth
7. **AA 4255** Vannas capsulotomy scissors, curved
8. **AA 4040** Castroviejo corneal scissors small blades
9. **AA 4275** Vannas capsulotomy scissors, 11mm angled
10. **AA 5145** Barraquer N.Holder short model micro jaws, without lock
11. **AA 3920** Hartman mosquito forceps straight
12. **AA 3925** Hartman mosquito forceps curved
13. **AA 1250** Dastoor Iris retractor straight
14. **AA 1685** Koman nair Iris spatula
15. **AA 1915** Lewis lens loop, small
16. **AA 5460** Bard-Parker handle #3 flat

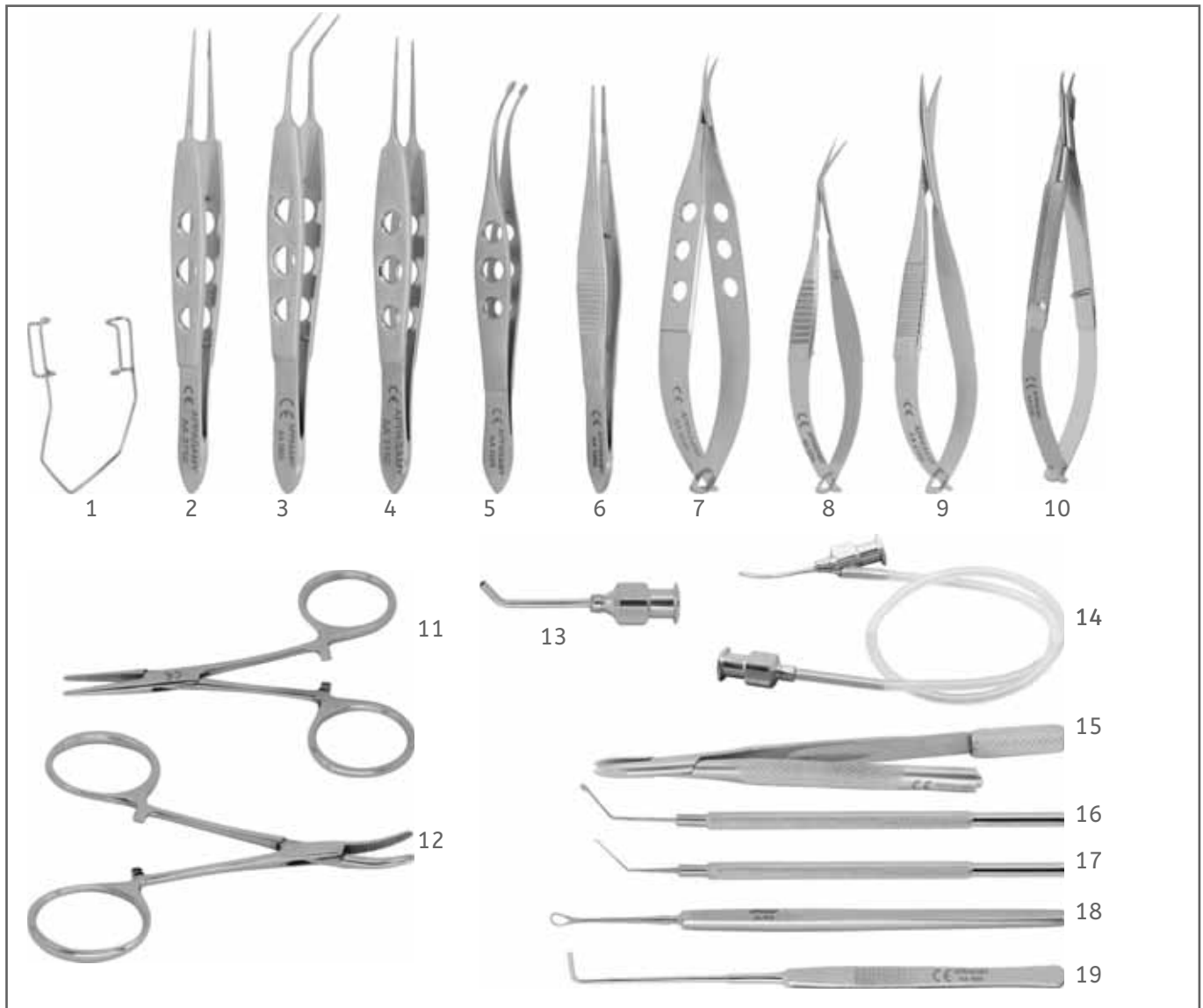

1. **AA 1009** Barraquer wire speculum, large
2. **AA 3750** Jaffe tying forceps smooth jaws with 5mm long platform straight
3. **AA 3805** McPherson IOL forceps, 11mm angled
4. **AA 3150** McPherson corneal forceps, 0.4mm, 1 x 2 teeth
5. **AA 3505** Arruga capsule forceps
6. **AA 3460** Wills hospital utility forceps
7. **AA 4040** Castroviejo corneal scissors small blades
8. **AA 4275** Vannas capsulotomy scissors, 11mm angled
9. **AA 4180** Westcott stitch scissors
10. **AA 5145** Barraquer N.Holder short model micro jaws, without lock
11. **AA 3920** Hartman mosquito forceps straight
12. **AA 3925** Hartman mosquito forceps curved
13. **AA 7105** Rycroft air injection cannula, 23 G
14. **AA 7420** Simcoe I/A cannula 23 G direct
15. **AA 5405** Castroviejo blade breaker
16. **AA 1911** Nightingale capsule polisher, posterior
17. **AA 1465** Sinskey II lens manipulating hook angled
18. **AA 1915** Lewis lens loop, small
19. **AA 1860** Smith lens expressor

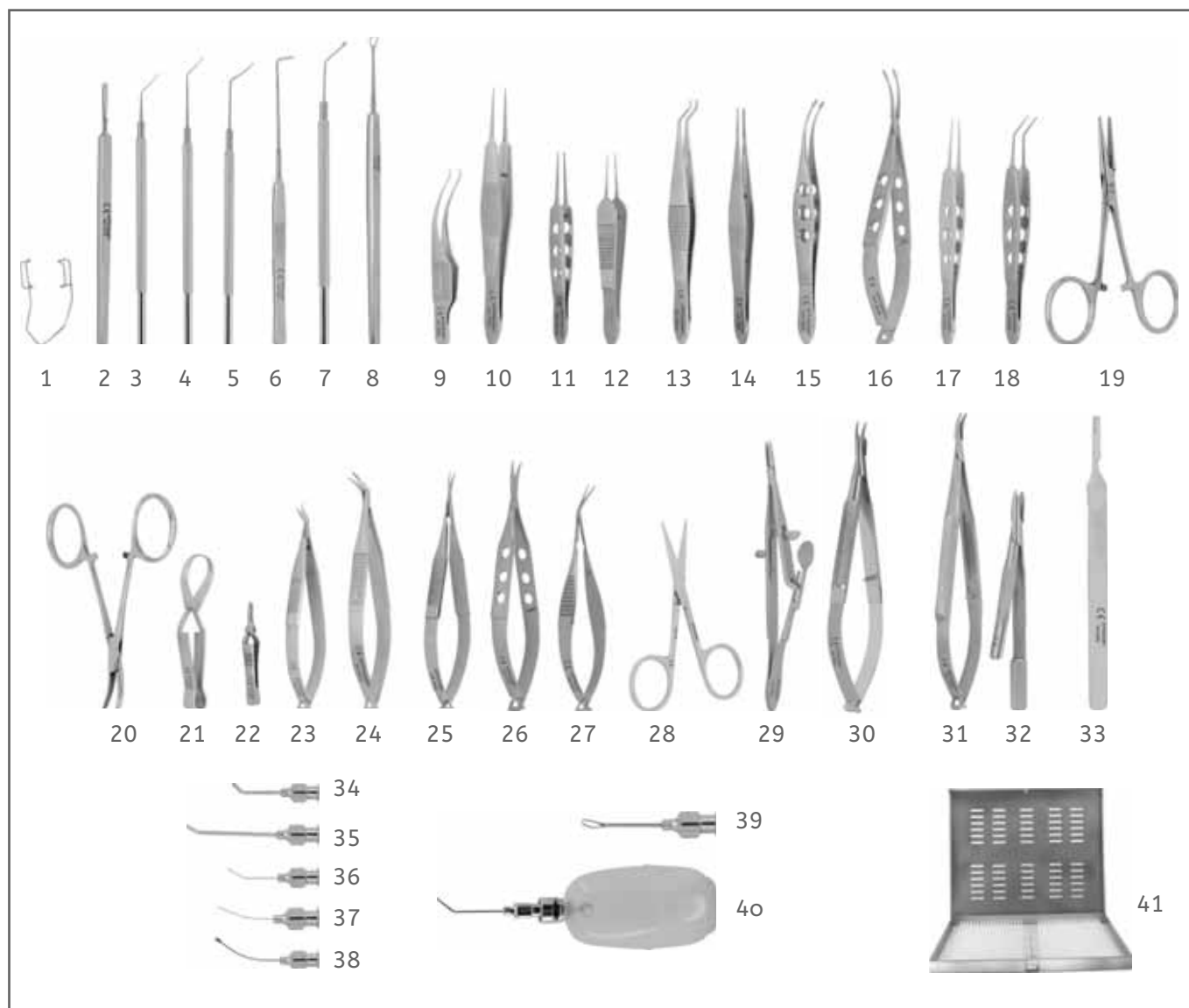

- 1.**AA 1009** Barraquer wire speculum, large
- 2.**AA 1370** Tooke corneal knife
- 3.**AA 1465** Sinsky II lens manipulating hook angled
- 4.**AA 1515** Kuglen Iris hook, angled
- 5.**AA 1655** Barraquer Iris spatula 0.25mm, angled
- 6.**AA 1860** Smith lens expressor
- 7.**AA 1911** Nightingale capsule polisher, posterior
- 8.**AA 1915** Lewis lens loop, small
- 9.**AA 3030** Colibri forceps 1 x 2 teeth 0.12mm
- 10.**AA 3180** Castroviejo suturing forceps 0.12mm,1 x 2 teeth
- 11.**AA 3255** Bishop-Harmon tissue forceps delicate 0.8mm
- 12.**AA 3275** St.Martin suturing forceps, 1 x 2 teeth
- 13.**AA 3340** Dastoor superior rectus forceps,1 x 2 teeth
- 14.**AA 3460** Wills hospital utility forceps
- 15.**AA 3505** Arruga capsule forceps
- 16.**AA 3690** Shepard IOL forceps
- 17.**AA 3790** McPherson tying forceps long handle
- 18.**AA 3805** McPherson IOL forceps, 11mm angled
- 19.**AA 3920** Hartman mosquito forceps straight
- 20.**AA 3925** Hartman mosquito forceps curved
- 21.**AA 3945** Baby Jones towel clamp
- 22.**AA 3950** Serrefine small straight
- 23.**AA 4010** Castroviejo corneoscleral scissors[s] blade left
- 24.**AA 4015** Castroviejo corneoscleral scissors [s] blade right
- 25.**AA 4100** Micro Iris scissors cur pointed small blades
- 26.**AA 4155** Westcott tenotomy scissors
- 27.**AA 4275** Vannas capsulotomy scissors angle forward 11mm
- 28.**AA 4500** Iris scissors straight 3.5" length
- 29.**AA 5020** Kalt needle holder straight
- 30.**AA 5145** Barraquer N.Holder short model micro jaws, without lock
- 31.**AA 5185** Barraquer needle holder standard jaws, curved w/o lock
- 32.**AA 5420** Swiss model blade breaker and holder, small
- 33.**AA 5460** Bard-Parker handle #3 flat
- 34.**AA 7105** Rycroft air injection cannula, 23 G
- 35.**AA 7145** Anterior chamber washout cannula 16 G
- 36.**AA 7205** Pearce hydo dissection cannula 35° angled,25 G
- 37.**AA 7230** Kellan hyderodelineation cannula curved bevel tip 26 G
- 38.**AA 7605** Jensen capsule polisher sand blast olive tip,23 G
- 39.**AA 7705** Knolle-Pearce irrigating vectis [4mm wide,7mm long loop]
- 40.**AA 7830** Silicone bulb with adaptor
- 41.**AA 8020** Appasamy sterilization box with two silicone mats

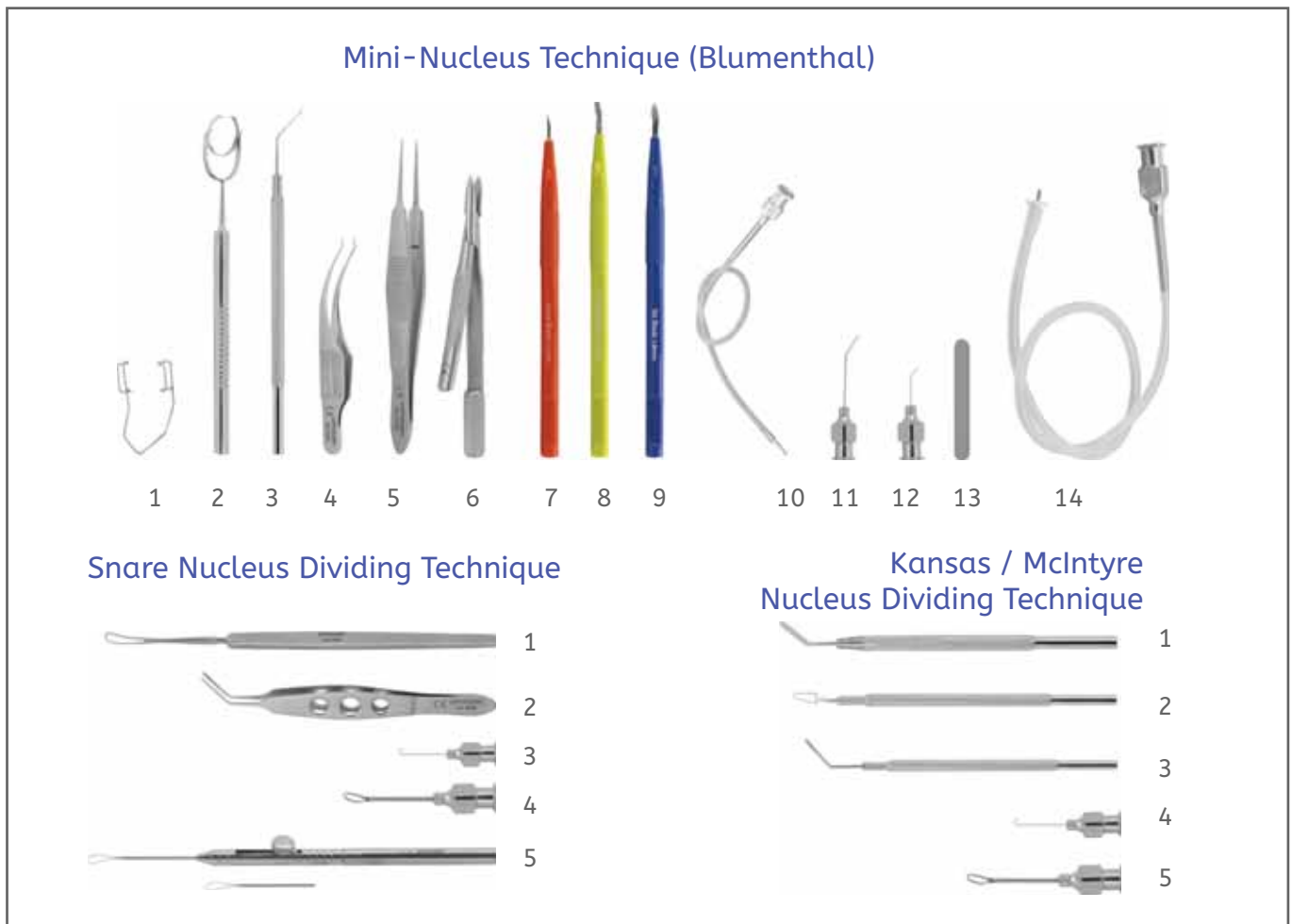

Mini-nucleus technique (Blumenthal)

1. **AA 1009** Barraquer wire speculum, large
2. **AA 1817** Shepard fixation ring
3. **AA 1993** Agarwal phaco chopper 1mm fully cutting edge
4. **AA 3030** Colibri forceps 1 x 2 teeth 0.12mm
5. **AA 3180** Castroviejo suturing forceps 0.12mm, 1 x 2 teeth
6. **AA 5420** Swiss model blade breaker and holder, small
7. **AA 560012** Lance knife (side port blade), 1.2mm
8. **AA 561021** Tunnel knife (crescent blade), 2.1mm
9. **AA 562028** Slit knife (Entry Keratome blade), 2.8mm
10. **AA 7150** Lewickly anterior chamber maintainer cannula
11. **AA 7200** Blumenthal cannula 25 G
12. **AA 7201** Blumenthal cannula 27G
13. **AA 7202** IOL glide silicone 35mm length x 5mm wide
14. **AA 7960** Infusion cannula size 2.5mm

Snare nucleus dividing technique

1. **AA 1935** Keener-Arlt lens loop strong curve
2. **AA 3908** Kansas nucleus removal forceps straight
3. **AA 7215** Gimbel shaped hydrodissector, 25 G
4. **AA 7705** Knolle-Pearce irrigating vectis [4mm wide, 7mm long loop]
5. **AA 1917** Appa -snare nucleus dividing snare, complete set

Kansas / McIntyre nucleus dividing technique

1. **AA 1965** Kansas nucleus bisector
2. **AA 1970** Kansas nucleus trisector right
3. **AA 1975** Kansas nucleus vectis solid right
4. **AA 7215** Gimbel 'U' shaped hydrodissector, 25 G
5. **AA 7705** Knolle-Pearce irrigating vectis [4mm wide, 7mm long loop]

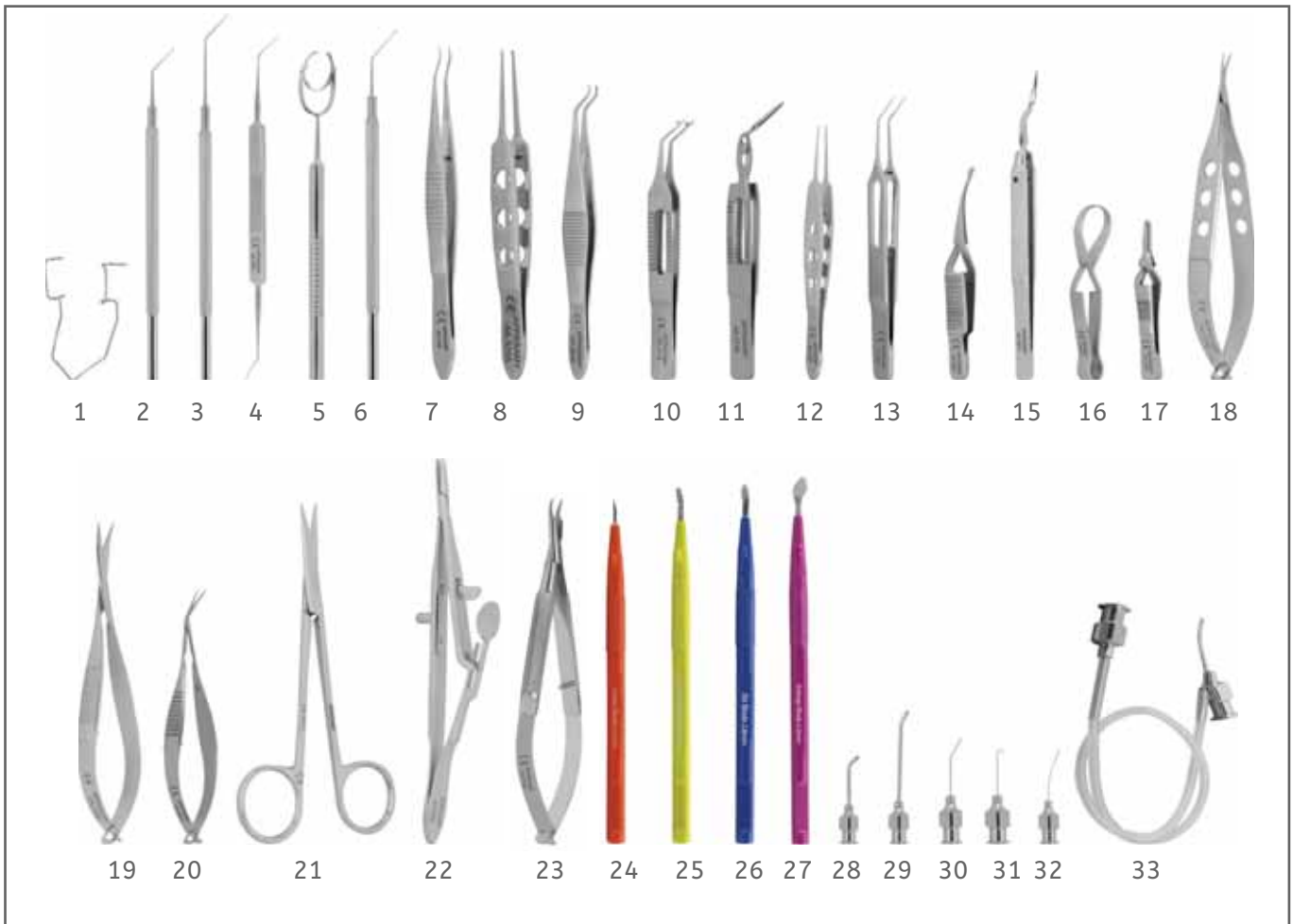

- 01. **AA 1025** Kratz -Barraquer wire speculum, big
- 02. **AA 1465** Sinsky II lens manipulating hook angled
- 03. **AA 1597** Akahoshi nucleus ball sustainer
- 04. **AA 1682** Castroviejo cyclodialysis spatula, 0.50mm wide
- 05. **AA 1817** Shepard fixation ring
- 06. **AA 1993** Agarwal phaco chopper 1mm fully cutting edge
- 07. **AA 3145** Lim's corneoscleral forceps 0.12mm, 1 x 2 teeth
- 08. **AA 3255** Bishop-Harmon tissue forceps delicate 0.8mm
- 09. **AA 3340** Dastoor superior rectus forceps, 1 x 2 teeth
- 10. **AA 3742** Appasamy lens folding forceps
- 11. **AA 3744** Appasamy lens inserting forceps cross action
- 12. **AA 3790** McPherson tying forceps St. Long handle
- 13. **AA 3855** Utrata capsulorhexis forceps, long straight shanks, flat handle
- 14. **AA 3906** Dodick nucleus cracking forceps
- 15. **AA 3914** Akahoshi phaco prechopper curved
- 16. **AA 3945** Baby Jones towel clamp
- 17. **AA 3950** Serrefine small straight
- 18. **AA 4040** Castroviejo corneal scissors small blades
- 19. **AA 4180** Westcott stitch scissors
- 20. **AA 4275** Vannas capsulotomy scissors, 11mm angled
- 21. **AA 4510** Eye scissors straight 4 1/2" length
- 22. **AA 5020** Kalt needle holder straight
- 23. **AA 5145** Barraquer N.Holder short model micro jaws, without lock
- 24. **AA 560012** Lance knife (side port blade), 1.2 mm
- 25. **AA 561021** Tunnel knife (crescent blade), 2.1 mm
- 26. **AA 562028** Slit knife (Entry Keratome blade), 2.8 mm
- 27. **AA 563050** Slit Enlarge knife (IOL Implant blade), 5.0 mm
- 28. **AA 7105** Rycroft air injection cannula, 23 G
- 29. **AA 7145** Anterior chamber washout cannula 16 G
- 30. **AA 7205** Pearce hydrodissection cannula , 35°. Angled 25 G
- 31. **AA 7215** Gimbel 'U' shaped hydrodissector, 25 G
- 32. **AA 7230** Kellan hydrodelineation cannula curved bevel tip 25 G
- 33. **AA 7420** Simcoe I/A cannula 23 G direct

AA - Stainless Steel, AAT - Titanium

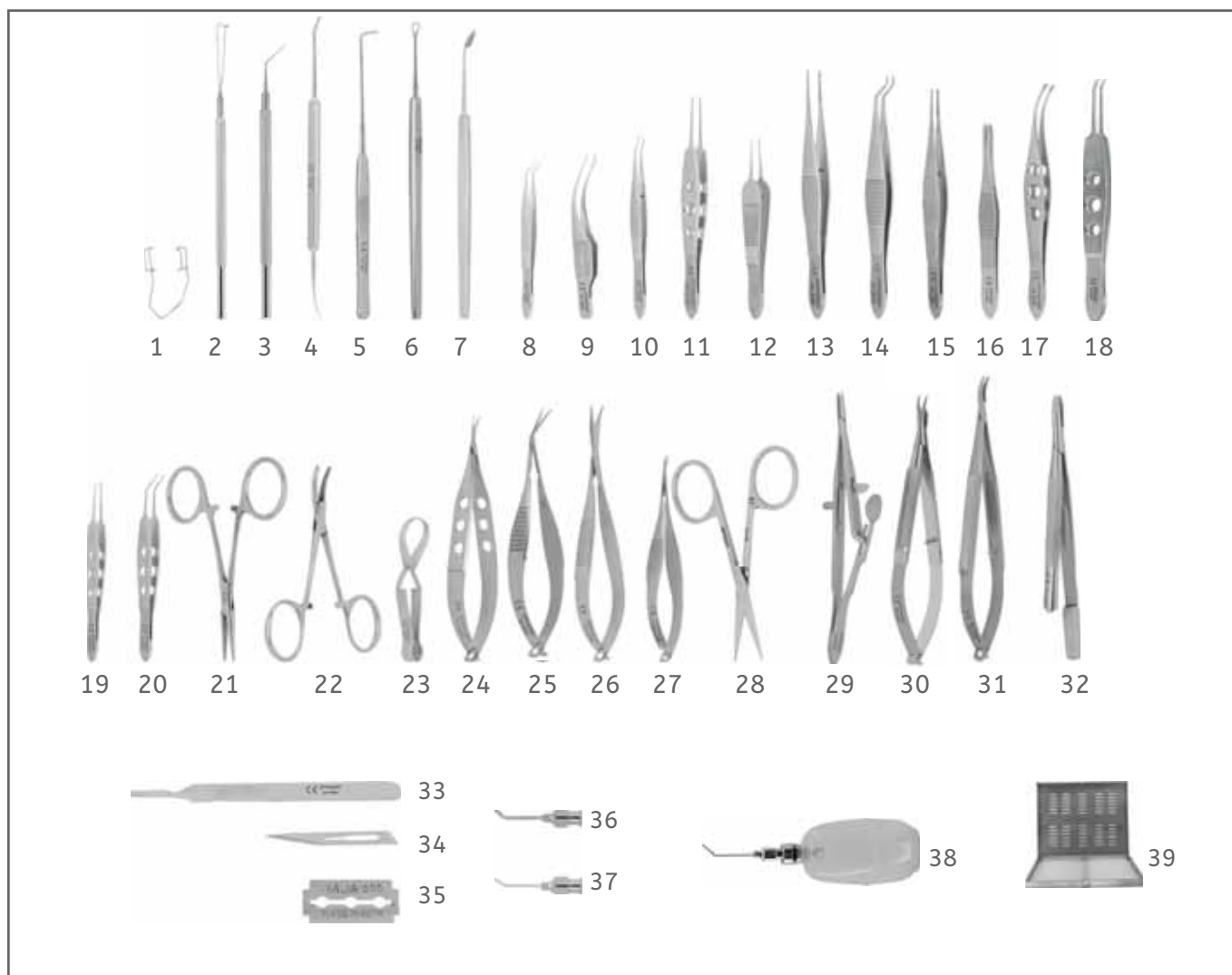

1. **AA 1009** Barraquer wire speculum, large
2. **AA 1250** Dastoor Iris retractor straight
3. **AA 1465** Sinskey II lens manipulating hook angled
4. **AA 1685** Koman nair Iris spatula double
5. **AA 1860** Smith lens expressor
6. **AA 1915** Lewis lens loop, small
7. **AA 1963** Cautery cone type copper
8. **AA 3025** Hess Iris forceps 1 x 2 teeth standard model
9. **AA 3030** Colibri forceps 1 x 2 teeth 0.12mm
10. **AA 3145** Lims corneoscleral forceps 0.12mm, 1 x 2 teeth
11. **AA 3150** McPherson corneal forceps st.0.4mm 1 x 2 teeth
12. **AA 3275** St.Martin suturing forceps, 1 x 2 teeth
13. **AA 3300** Fixation forceps 1 x 2 teeth
14. **AA 3340** Dastoor superior rectus forceps, 1 x 2 teeth
15. **AA 3460** Wills hospital utility forceps
16. **AA 3485** Beer cilia forceps
17. **AA 3505** Arruga capsule forceps
18. **AA 3755** Jaffe tying forceps smooth jaws with 5mm long platform curved
19. **AA 3790** McPherson tying forceps St. Long handle
20. **AA 3805** McPherson IOL forceps, 11mm angled
21. **AA 3920** Hartman mosquito forceps straight
22. **AA 3925** Hartman mosquito forceps curved
23. **AA 3945** Baby Jones towel clamp
24. **AA 4040** Castroviejo corneal scissors small blades
25. **AA 4275** Vannas capsulotomy scissors angle forward 11mm
26. **AA 4180** Westcott stitch scissors
27. **AA 4255** Vannas capsulotomy scissors, curved
28. **AA 4500** Iris scissors straight 3.5" length
29. **AA 5020** Kalt needle holder straight
30. **AA 5145** Barraquer N.Holder short model micro jaws, without lock
31. **AA 5185** Barraquer N.Holder standard jaws, curved w/o lock
32. **AA 5405** Castroviejo blade breaker and holder, big
33. **AA 5460** Bard-Parker handle #3 flat
34. **AA 5560** Bard-Parker blade
35. **AA 5570** Carbon razor breakable blade
36. **AA 7105** Rycroft air injection cannula, 23 G
37. **AA 7135** Bishop-Harmon anterior chamber cannula 19 G
38. **AA 7830** Silicone bulb with adaptor
39. **AA 8020** Appasamy sterilization box with two silicone mats

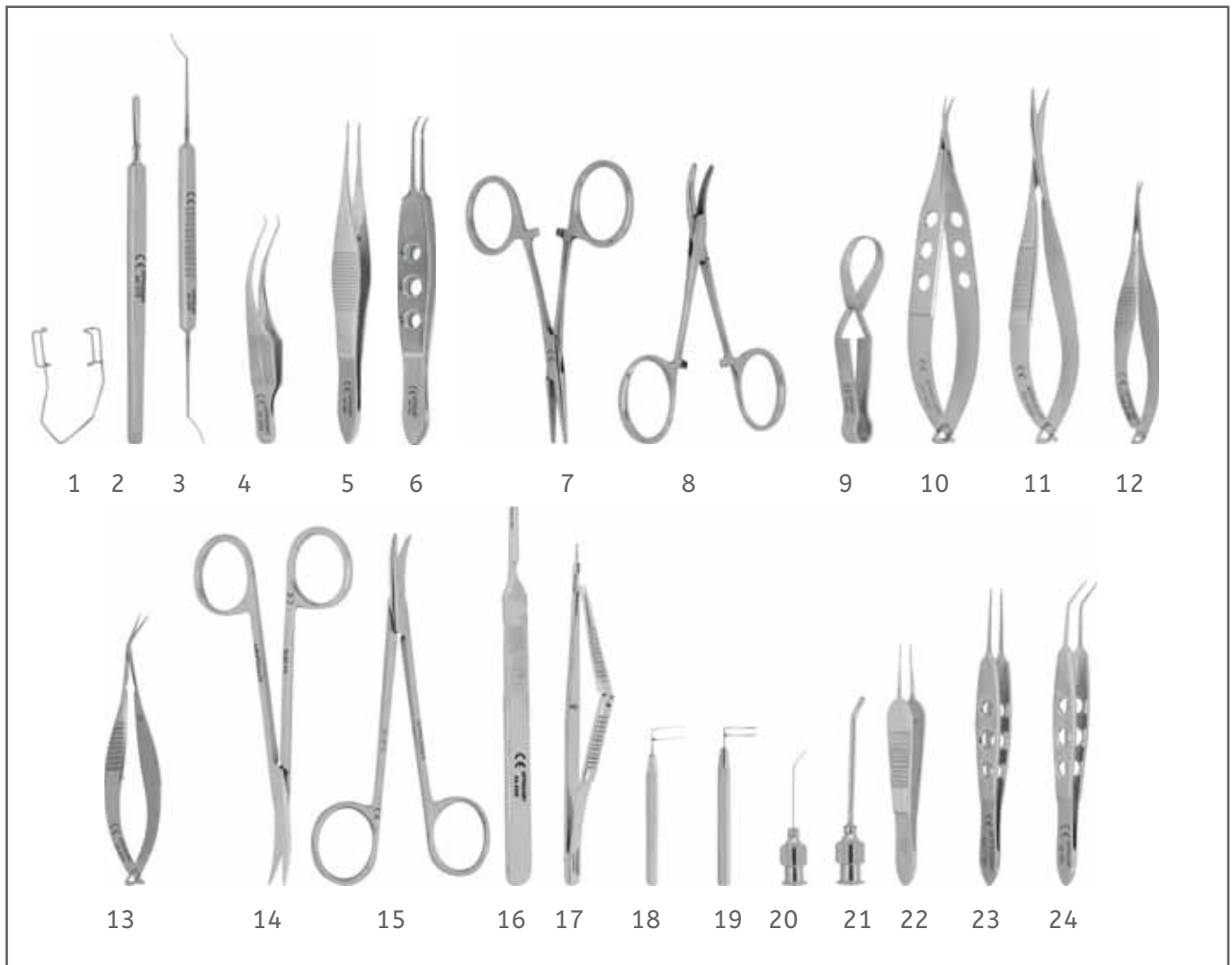

1. **AA 1009** Barraquer wire speculum, large
2. **AA 1370** Tooke corneal knife
3. **AA 1670** Castroviejo synechia spatula, double ended
4. **AA 3030** Colibri forceps 1 x 2 teeth 0.12mm
5. **AA 3450** Eye dressing forceps straight
6. **AA 3755** Jaffe tying forceps smooth jaws with 5mm long platform curved
7. **AA 3920** Hartman mosquito forceps straight
8. **AA 3925** Hartman mosquito forceps curved
9. **AA 3945** Baby Jones towel clamp
10. **AA 4040** Castroviejo corneal scissors small blades
11. **AA 4180** Westcott stitch scissors
12. **AA 4255** Vannas capsulotomy scissors, curved
13. **AA 4275** Vannas capsulotomy scissors, 11mm angled
14. **AA 4515** Eye scissors curved 4 1/2" length
15. **AA 4535** Stevens tenotomy scissors curved
16. **AA 5460** Bard-Parker handle #3 flat
17. **AA 6070** Kelly descemet membrane punch, 1.0mm
18. **AA 6160** Harms trabeculotomy probe right
19. **AA 6170** Harms trabeculotomy probe left
20. **AA 7107** Rycroft air injection cannula 27 G
21. **AA 7145** Anterior chamber washout cannula 16 G
22. **AA 3275** St.Martin suturing forceps, 1 x 2 teeth
23. **AA 3150** McPherson corneal forceps st. 0.4mm 1 x 2 teeth
24. **AA 3805** McPherson IOL forceps, 11mm angled

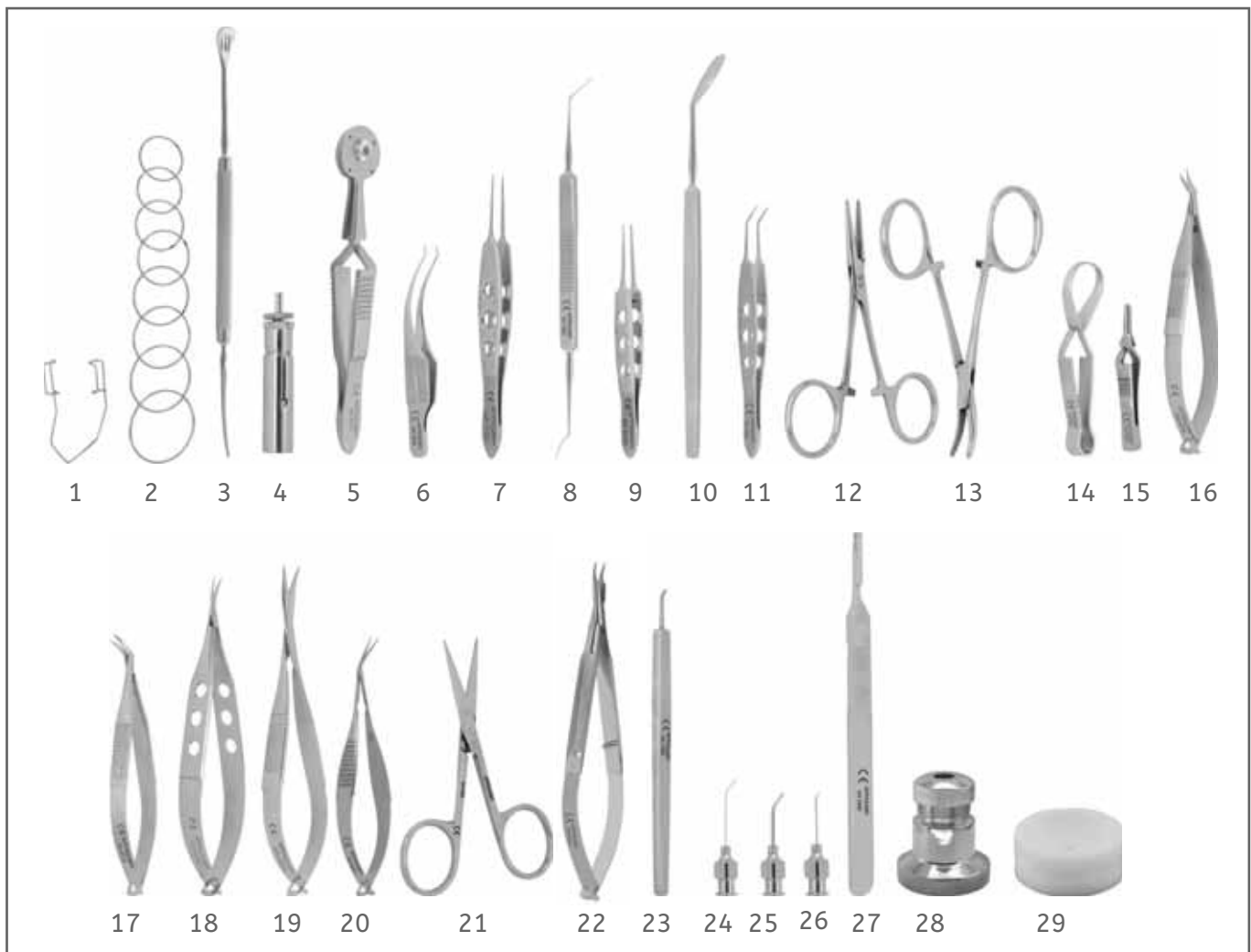

- 01. **AA 1009** Barraquer wire speculum, large
- 02. **AA 1280** Flieringa scleral fixation ring (set of 8 sizes)
- 03. **AA 1710** Paton spatula & spoon
- 04. **AA 2015** Castroviejo corneal trephine size 7.5mm Dia
- 05. **AA 2070** Dastoor corneal graft holding forceps
- 06. **AA 3030** Colibri forceps 1 x 2 teeth 0.12mm
- 07. **AA 3150** McPherson corneal forceps, 0.4mm, 1 x 2 teeth
- 08. **AA 1682** Castroviejo cyclodialysis spatula, 0.50mm wide
- 09. **AA 3255** Bishop-Harmon tissue forceps delicate 0.8mm
- 10. **AA 2040** Dastoor keratoplasty spatula
- 11. **AA 3800** Kelman-McPherson forceps 7.5mm angle long handle
- 12. **AA 3920** Hartman mosquito forceps straight
- 13. **AA 3925** Hartman mosquito forceps curved
- 14. **AA 3945** Baby Jones towel clamp
- 15. **AA 3950** Serrefine small straight
- 16. **AA 4010** Castroviejo corneoscleral scissors[s] blade left
- 17. **AA 4015** Castroviejo corneoscleral scissors [s] blade right
- 18. **AA 4040** Castroviejo corneal scissors small blades
- 19. **AA 4180** Westcott stitch scissors
- 20. **AA 4275** Vannas capsulotomy scissors, 11mm angled
- 21. **AA 4500** Iris scissors straight 3.5" length
- 22. **AA 5145** Barraquer N.Holder short model micro jaws, without lock
- 23. **AA 1360** Paufigue graft knife
- 24. **AA 7107** Rycroft air injection cannula 27 G
- 25. **AA 7125** Bracken A/C cannula curved 19 G
- 26. **AA 7130** Knolle anterior chamber irrigating cannula 23 G
- 27. **AA 5460** Bard-Parker handle #3 flat
- 28. **AA 2050** Tudor thomas corneal graft stand
- 29. **AA 2060** Lieberman corneal cutting block teflon

AA - Stainless Steel, AAT - Titanium

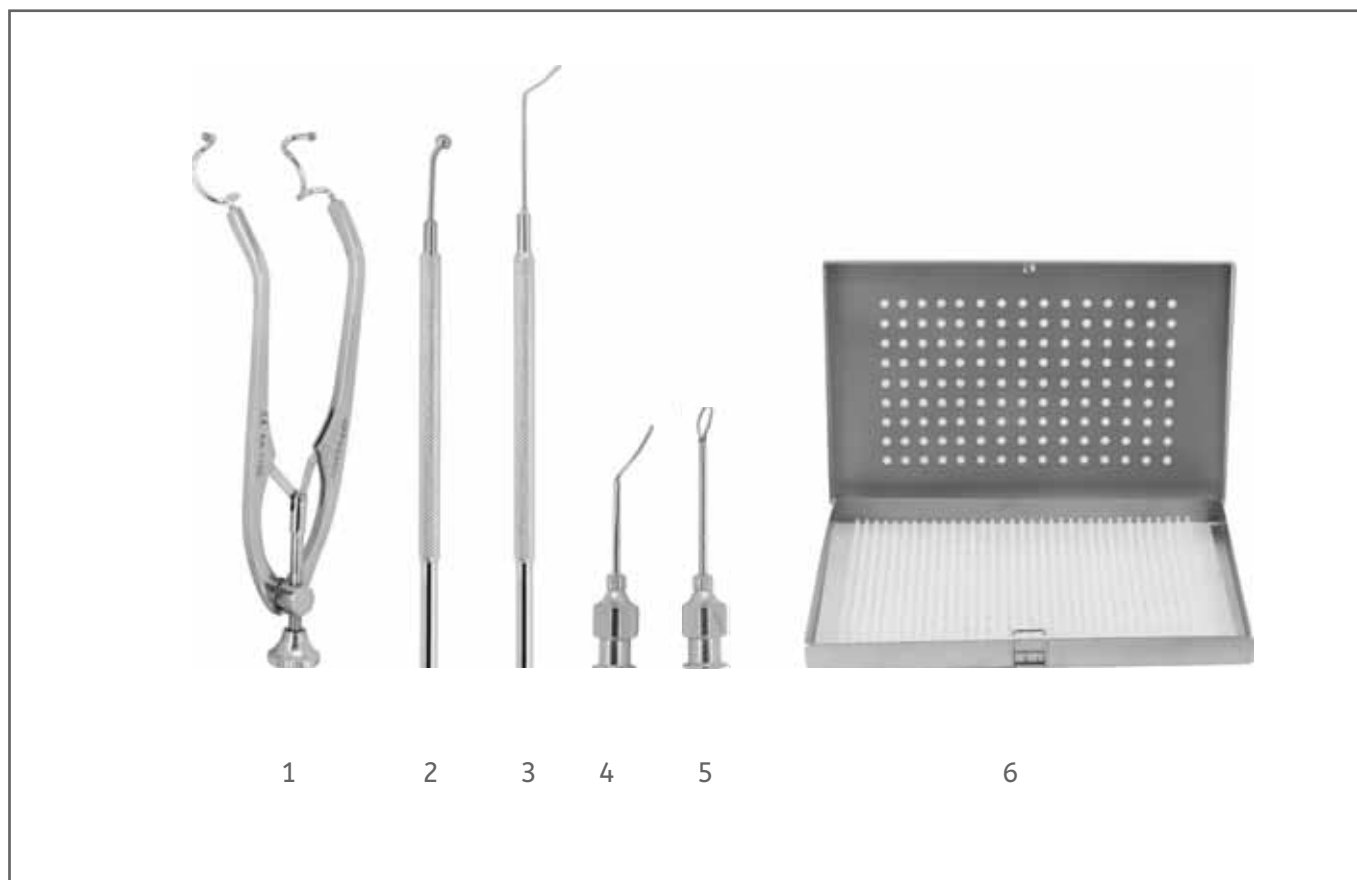

- 01. **AA 1195** Castroviejo LASIK speculum
- 02. **AA 1308** LASIK depressor
- 03. **AA 1683** LASIK spatula
- 04. **AA 7855** LASIK flap irrigator
- 05. **AA 7891** Rubenstein LASIK irrigating cannula
- 06. **AA 8005** Sterilization box with silicone mat

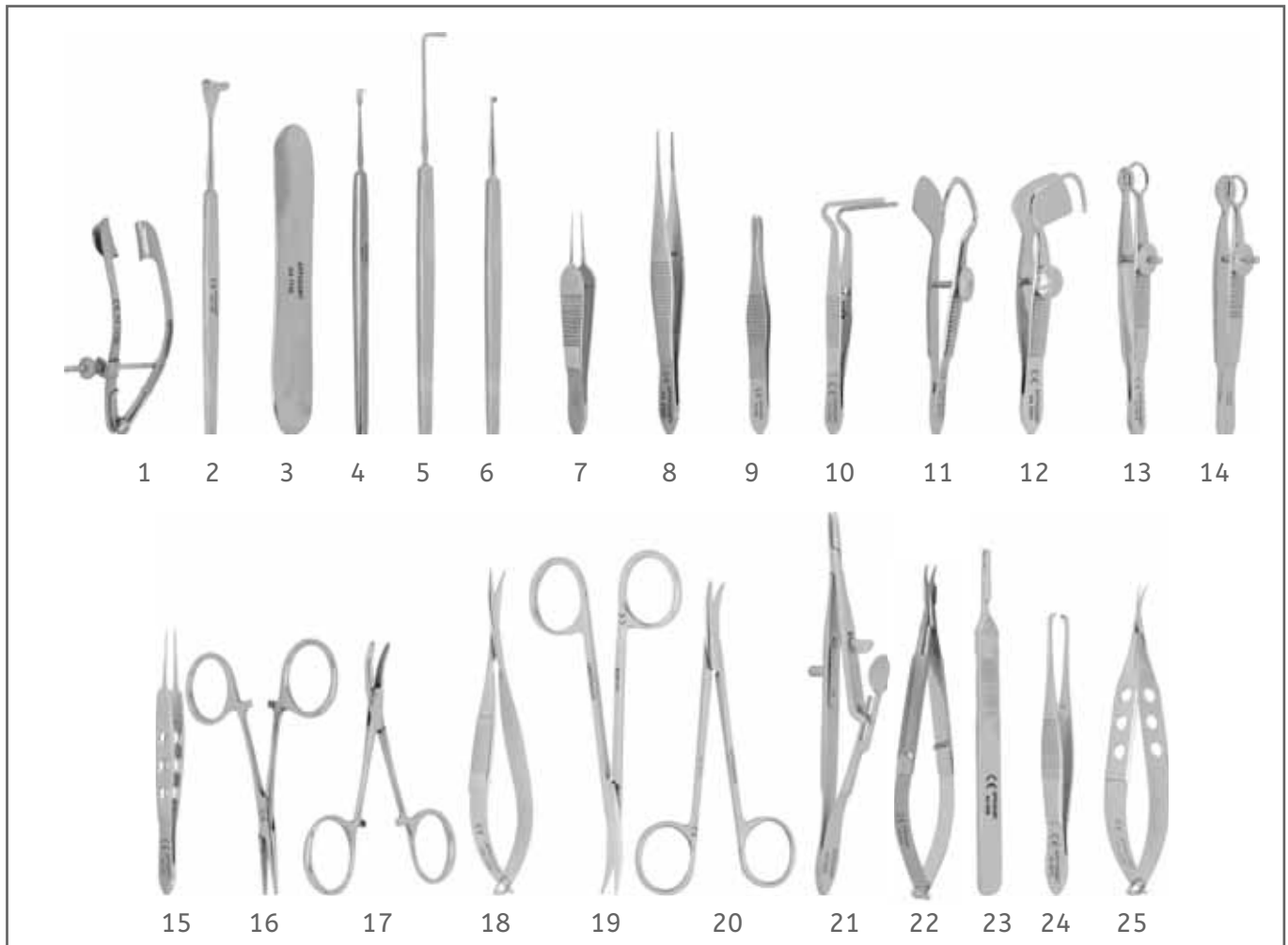

- 01. **AA 1120** Lancaster eye speculum
- 02. **AA 1260** Desmarres lid retractor size 0
- 03. **AA 1740** Jaeger lid plate
- 04. **AA 1810** Fixation hook double sharp 2.0 x 1.5mm small
- 05. **AA 1827** Graefe muscle hook size 3
- 06. **AA 1877** Meyerhoefer chalazion curette size 2
- 07. **AA 3275** St.Martin suturing forceps, 1 x 2 teeth
- 08. **AA 3300** Fixation forceps 1 x 2 teeth
- 09. **AA 3485** Beer cilia forceps
- 10. **AA 3565** Berke ptosis forceps 20mm
- 11. **AA 3600** Snellen entropium forceps left small
- 12. **AA 3605** Snellen entropium forceps right small
- 13. **AA 3615** Ayer chalazion forceps
- 14. **AA 3620** Lambert chalazion forceps
- 15. **AA 3790** McPherson tying forceps st. Long handle
- 16. **AA 3920** Hartman mosquito forceps straight
- 17. **AA 3925** Hartman mosquito forceps curved
- 18. **AA 4180** Westcott stitch scissors
- 19. **AA 4515** Eye scissors curved 4 1/2" length
- 20. **AA 4535** Stevens tenotomy scissors curved
- 21. **AA 5020** Kalt needle holder straight
- 22. **AA 5145** Barraquer N.Holder short model m.Jaws,w/o lock
- 23. **AA 5460** Bard-Parker handle #3 flat
- 24. **AA 3310** Fixation forceps-2x3 teeth angular
- 25. **AA 4040** Castroviejo corneal scissors small blades

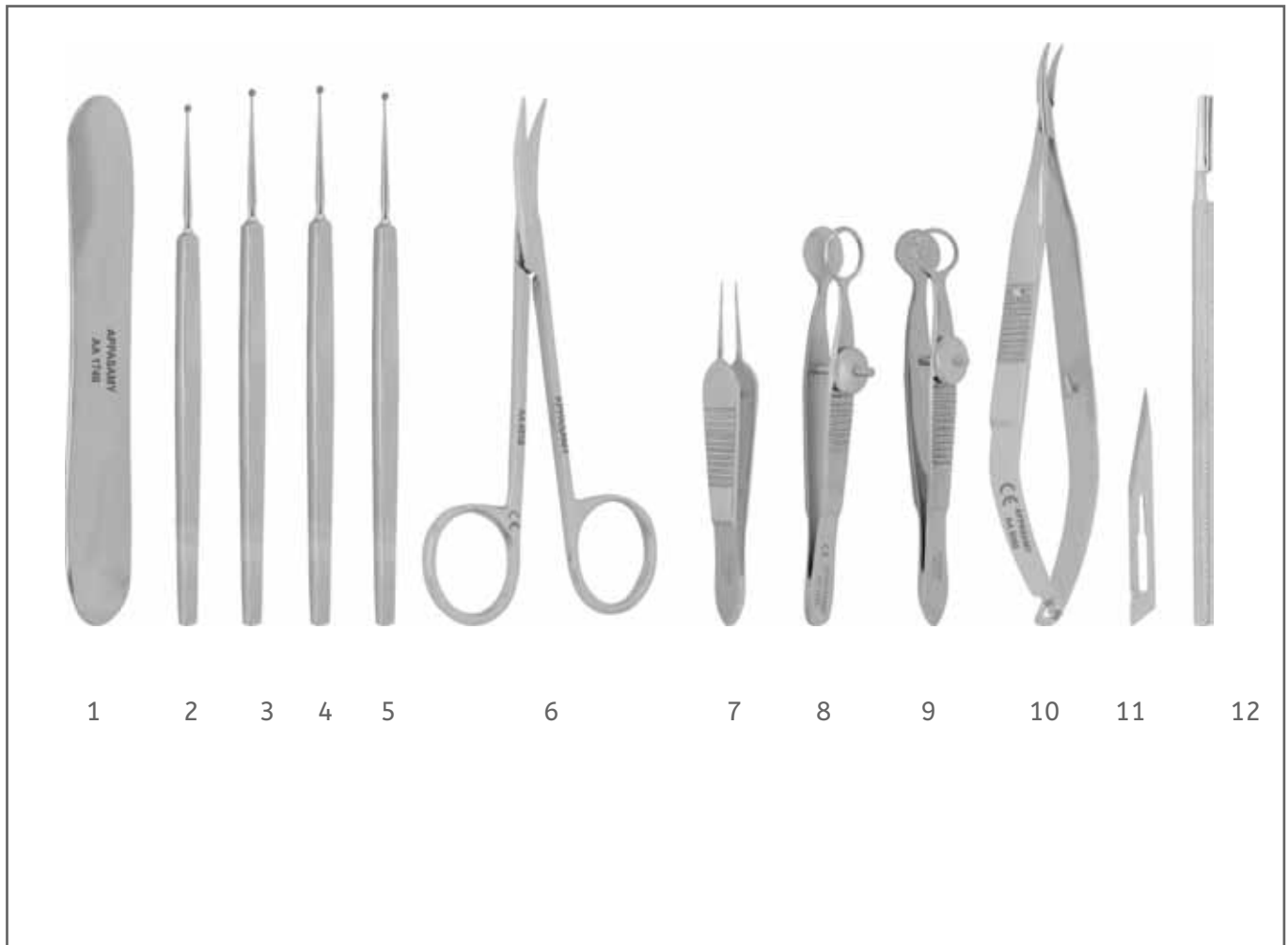

- 01. **AA 1740** Jaeger lid plate
- 02. **AA 1875** Meyerhoefer chalazion curette size 0, 1.50mm Dia
- 03. **AA 1876** Meyerhoefer chalazion curette size 1, 1.75mm Dia
- 04. **AA 1877** Meyerhoefer chalazion curette size 2, 2.25mm Dia
- 05. **AA 1878** Meyerhoefer chalazion curette size 3, 3.0mm Dia
- 06. **AA 4515** Eye scissors curved 4 1/2" length
- 07. **AA 3275** St.Martin suturing forceps, 1 x 2 teeth
- 08. **AA 3630** Hunt chalazion forceps, 12mm Dia
- 09. **AA 3625** Desmarres chalazion forceps 13mm/20mm Dia
- 10. **AA 5090** Castroviejo N.Holder std jaws curved with lock
- 11. **AA 5560** Bard-Parker blade #11
- 12. **AA 5465** Bard-Parker handle #3 round handle

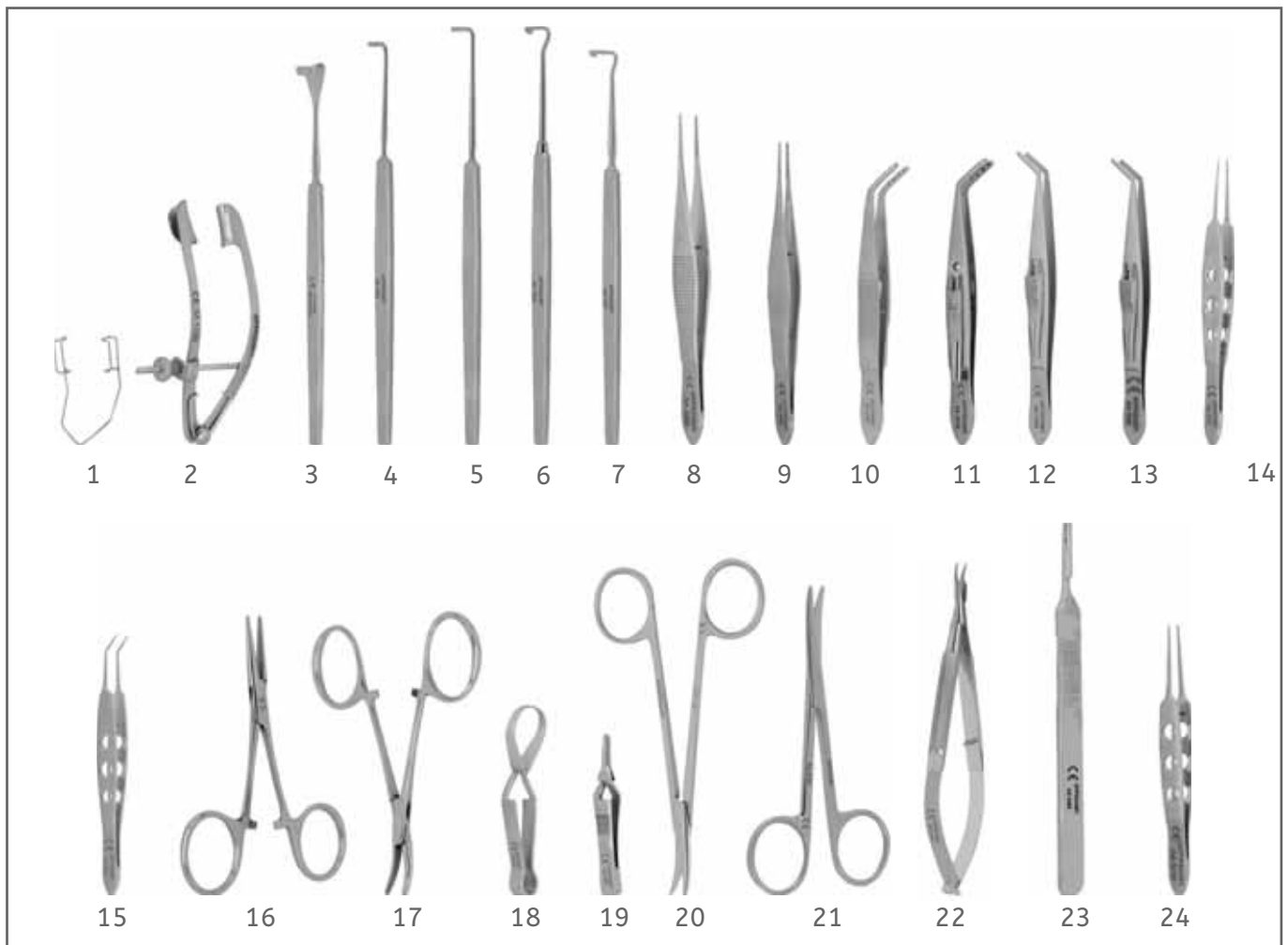

- 01. **AA 1009** Barraquer wire speculum, large
- 02. **AA 1120** Lancaster eye speculum
- 03. **AA 1260** Desmarres lid retractor size 0
- 04. **AA 1825** Graefe muscle hook size 1
- 05. **AA 1826** Graefe muscle hook size 2
- 06. **AA 1835** Jameson muscle hook small
- 07. **AA 1837** Jameson muscle hook large
- 08. **AA 3300** Fixation forceps 1 x 2 teeth
- 09. **AA 3460** Wills hospital utility forceps
- 10. **AA 3535** Jameson muscle forceps left child 4 teeth
- 11. **AA 3540** Jameson muscle forceps right child 4 teeth
- 12. **AA 3555** Worth advancement forceps left
- 13. **AA 3560** Worth advancement forceps right
- 14. **AA 3790** McPherson tying forceps st. Long handle
- 15. **AA 3800** Kelman-McPherson forceps 7.5mm angle long handle
- 16. **AA 3920** Hartman mosquito forceps straight
- 17. **AA 3925** Hartman mosquito forceps curved
- 18. **AA 3945** Baby Jones towel clamp
- 19. **AA 3950** Serrefine small straight
- 20. **AA 4535** Stevens tenotomy scissors curved
- 21. **AA 4555** Knapp strabismus scissors curved
- 22. **AA 5145** Barraquer N.Holder short model m.Jaws, w/o lock
- 23. **AA 5460** Bard-Parker handle #3 flat
- 24. **AA 3255** Bishop-Harmon tissue forceps delicate 0.8mm

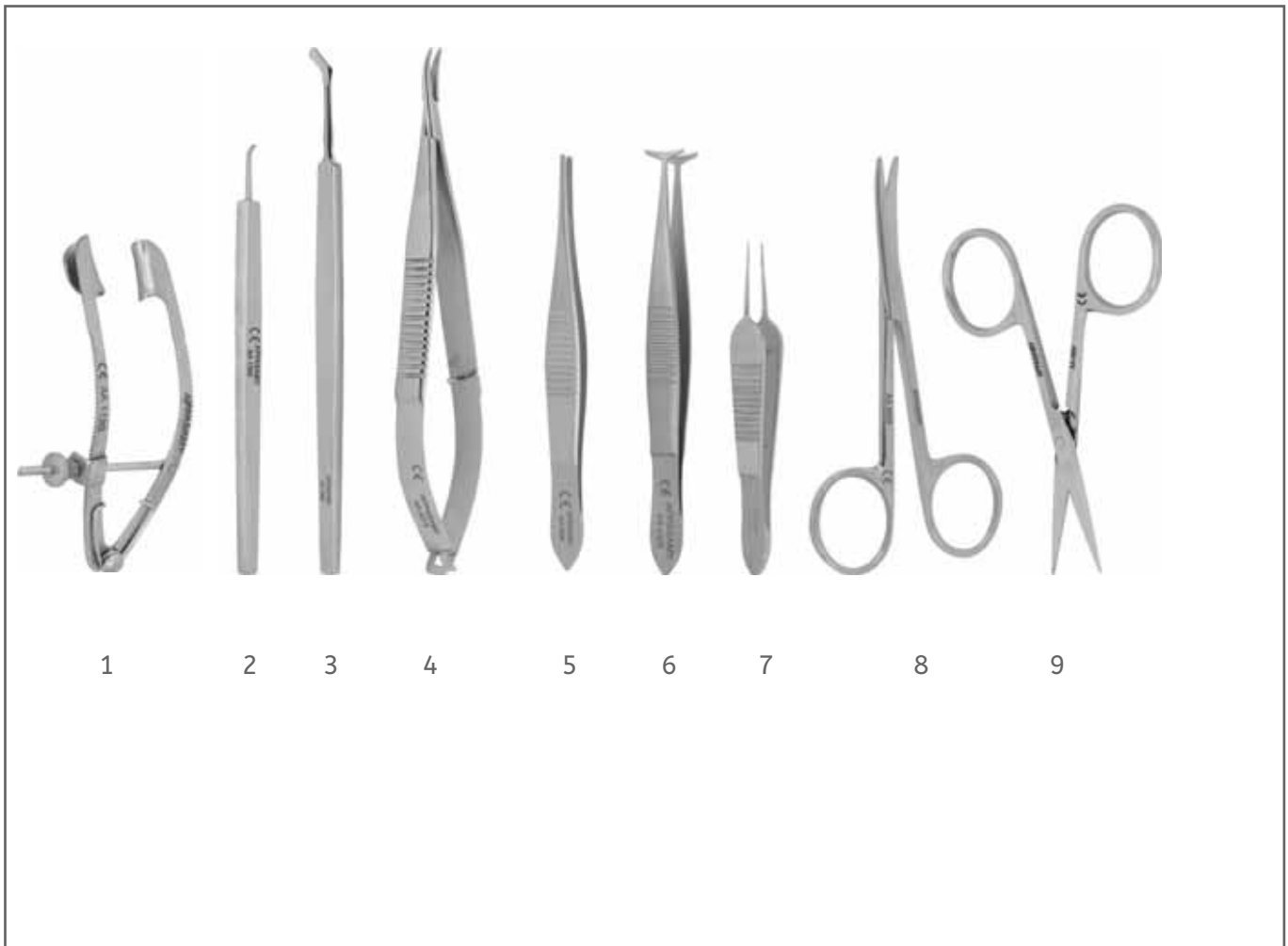

- 01.**AA 1120** Lancaster eye speculum
- 02.**AA 1360** Paufigue graft knife
- 03.**AA 1390** Paton corneal dissector
- 04.**AA 5075** Castroviejo N.Holder deli. Jaws curved without lock
- 05.**AA 3465** Bonaccolto utility forceps 1.2mm wide
- 06.**AA 3325** Green fixation forceps 10mm wide jaws
- 07.**AA 3275** St.Martin suturing forceps, 1 x 2 teeth
- 08.**AA 4555** Knapp strabismus scissors curved
- 09.**AA 4500** Iris scissors straight 3.5" length

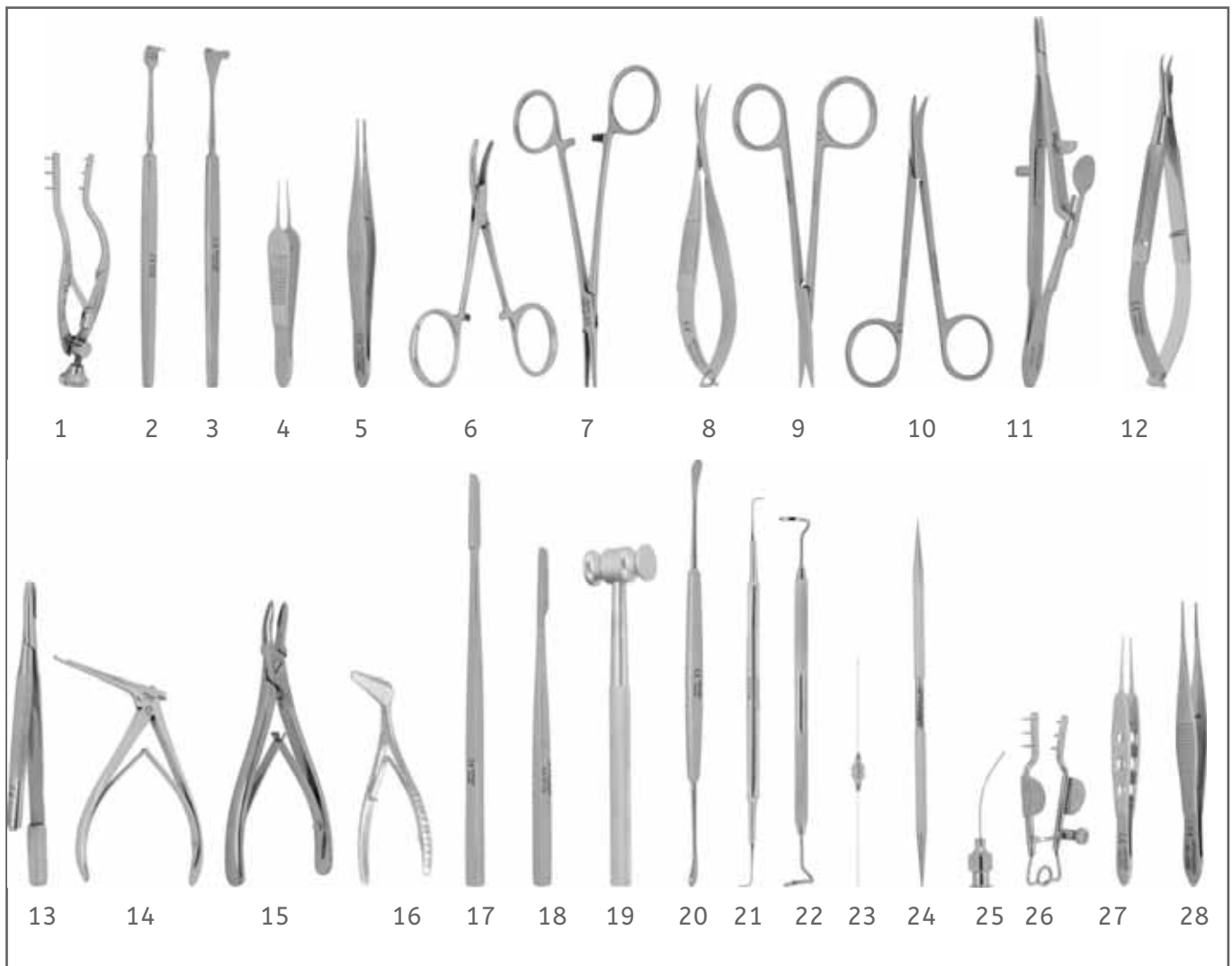

- 01. **AA 1200** Stevenson lacrimal sac retractor, 3x3 blunt prongs
- 02. **AA 1220** Knapp lacrimal sac retractor blunt
- 03. **AA 1260** Desmarres lid retractor size 0
- 04. **AA 3275** St.Martin suturing forceps, 1 x 2 teeth
- 05. **AA 3460** Wills hospital utility forceps
- 06. **AA 3925** Hartman mosquito forceps curved
- 07. **AA 3930** Halsted mosquito forceps straight
- 08. **AA 4180** Westcott stitch scissors
- 09. **AA 4510** Eye scissors straight 4 1/2"length
- 10. **AA 4535** Stevens tenotomy scissors curved
- 11. **AA 5020** Kalt needle holder straight
- 12. **AA 5145** Barraquer N.Holder short model m.Jaws,w/o lock
- 13. **AA 5405** Castroviejo blade breaker and holder,big
- 14. **AA 6010** Kerrison bone nibbling ronguer size 0
- 15. **AA 6030** Beyer bone nibbling ronguer single action
- 16. **AA 6040** Nasal speculum infant
- 17. **AA 6100** West lacrimal chisel straight
- 18. **AA 6110** West bone gouge
- 19. **AA 6120** Mallet for DCR
- 20. **AA 6130** Freer periosteal elevator
- 21. **AA 6140** Traquair periosteal elevator
- 22. **AA 6150** Pigtail probe with suture holes
- 23. **AA 6175** Bowman lacrimal probe set, malleable stainless steel
- 24. **AA 6440** Castroviejo lacrimal dialator (double end)
- 25. **AA 7040** West lacrimal cannula blunt tip with side port
- 26. **AA 1185** Mueller lacrimal sac retractor
- 27. **AA 3790** McPherson tying forceps St.Long handle
- 28. **AA 3300** Fixation forceps 1 x 2 teeth

AA - Stainless Steel, AAT - Titanium

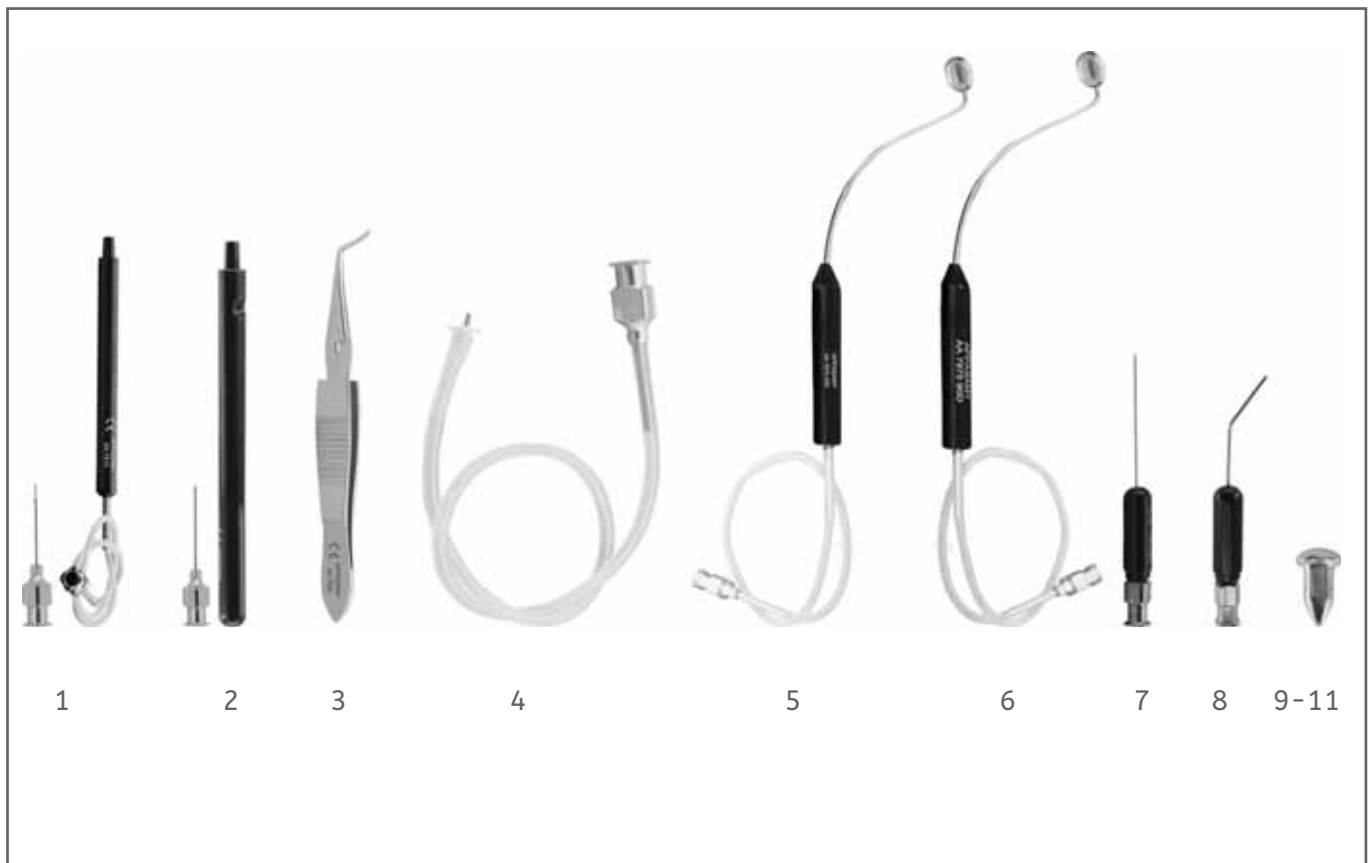

- 01. **AA 7915** Tapered extrusion handpiece cannula
- 02. **AA 7920** Charles flute needle cannula
- 03. **AA 7925** Scleral plug holding forceps
- 04. **AA 7960** Infusion cannula 2.5 mm, Beveled tip
- 05. **AA 7970** 45 Diopter irrigating contact lens
- 06. **AA 7975** 90 Diopter irrigating contact lens
- 07. **AA 7980** Membrane peeler
- 08. **AA 7985** May 30° bent needle
- 09. **AA 7950** Scleral plug, 18 G
- 10. **AA 7951** Scleral plug, 19 G
- 11. **AA 7952** Scleral plug, 20 G

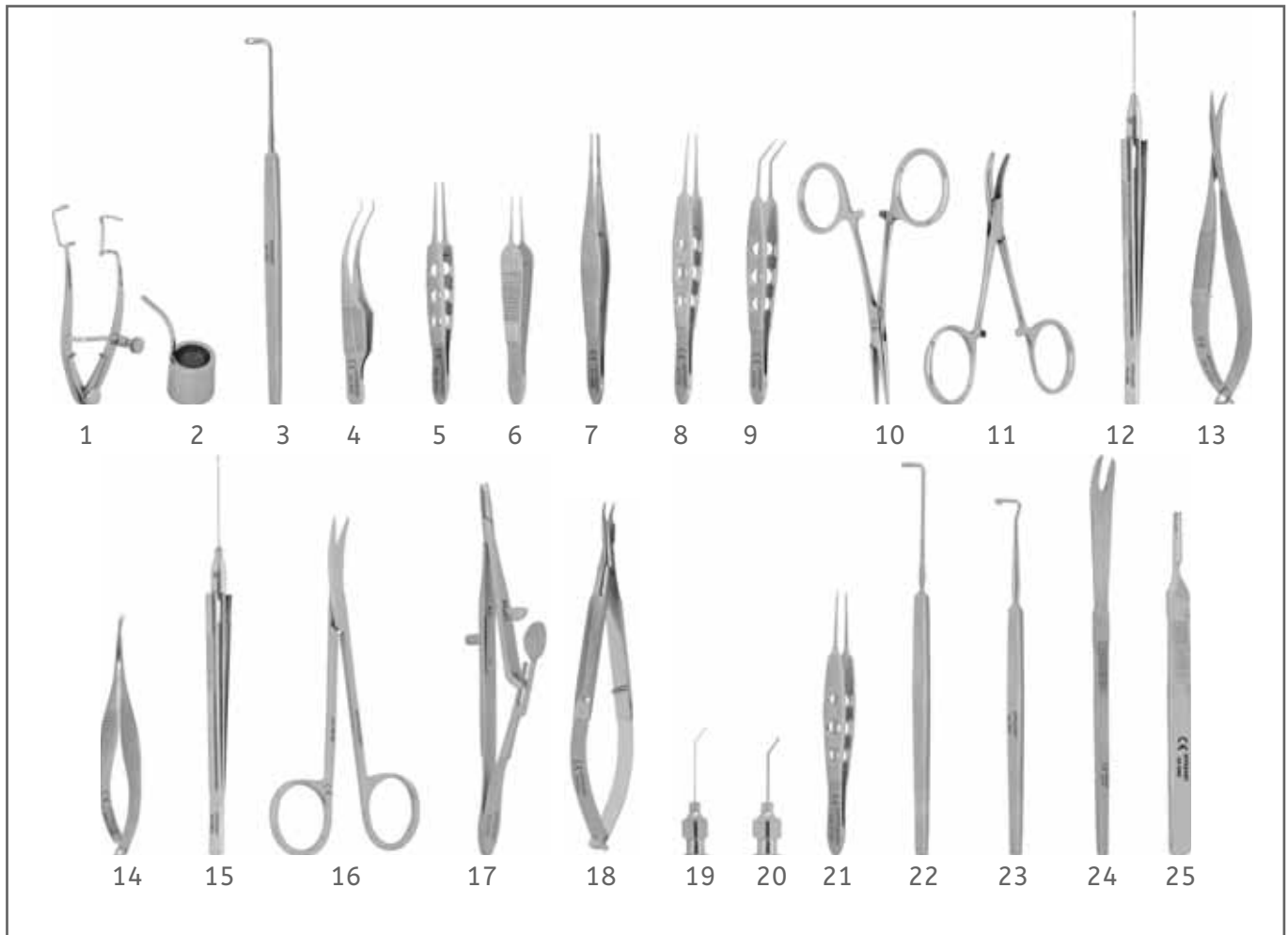

- 01. **AA 1090** Clark eye speculum small
- 02. **AA 1300** Schepens scleral depressor small #8
- 03. **AA 1830** Gass Retinal detachment hook
- 04. **AA 3030** Colibri forceps 1 x 2 teeth 0.12mm
- 05. **AA 3255** Bishop-Harmon tissue forceps delicate 0.8mm
- 06. **AA 3275** St.Martin suturing forceps, 1 x 2 teeth
- 07. **AA 3460** Wills hospital utility forceps
- 08. **AA 3790** McPherson tying forceps straight long handle
- 09. **AA 3805** McPherson IOL forceps, 11mm angled
- 10. **AA 3920** Hartman mosquito forceps straight
- 11. **AA 3925** Hartman mosquito forceps curved
- 12. **AA 3960** Vitreous forceps 20 G smooth jaws, straight
- 13. **AA 4180** Westcott stitch scissors
- 14. **AA 4255** Vannas capsulotomy scissors, curved
- 15. **AA 4450** Vitreous scissors 20 G straight
- 16. **AA 4515** Eye scissors curved 4 1/2" length
- 17. **AA 5020** Kalt needle holder straight
- 18. **AA 5145** Barraquer N.Holder short model micro jaws, w/o lock
- 19. **AA 7107** Rycroft air injection cannula 27 G
- 20. **AA 7135** Bishop-Harmon anterior chamber cannula 19 G
- 21. **AA 3150** McPherson corneal forceps, 0.4mm, 1 x 2 teeth
- 22. **AA 1827** Graefe Muscle hook size 3
- 23. **AA 1837** Jameson muscle hook large
- 24. **AA 1270** Schepens forked orbital retractor
- 25. **AA 5460** Bard-Parker handle #3 flat

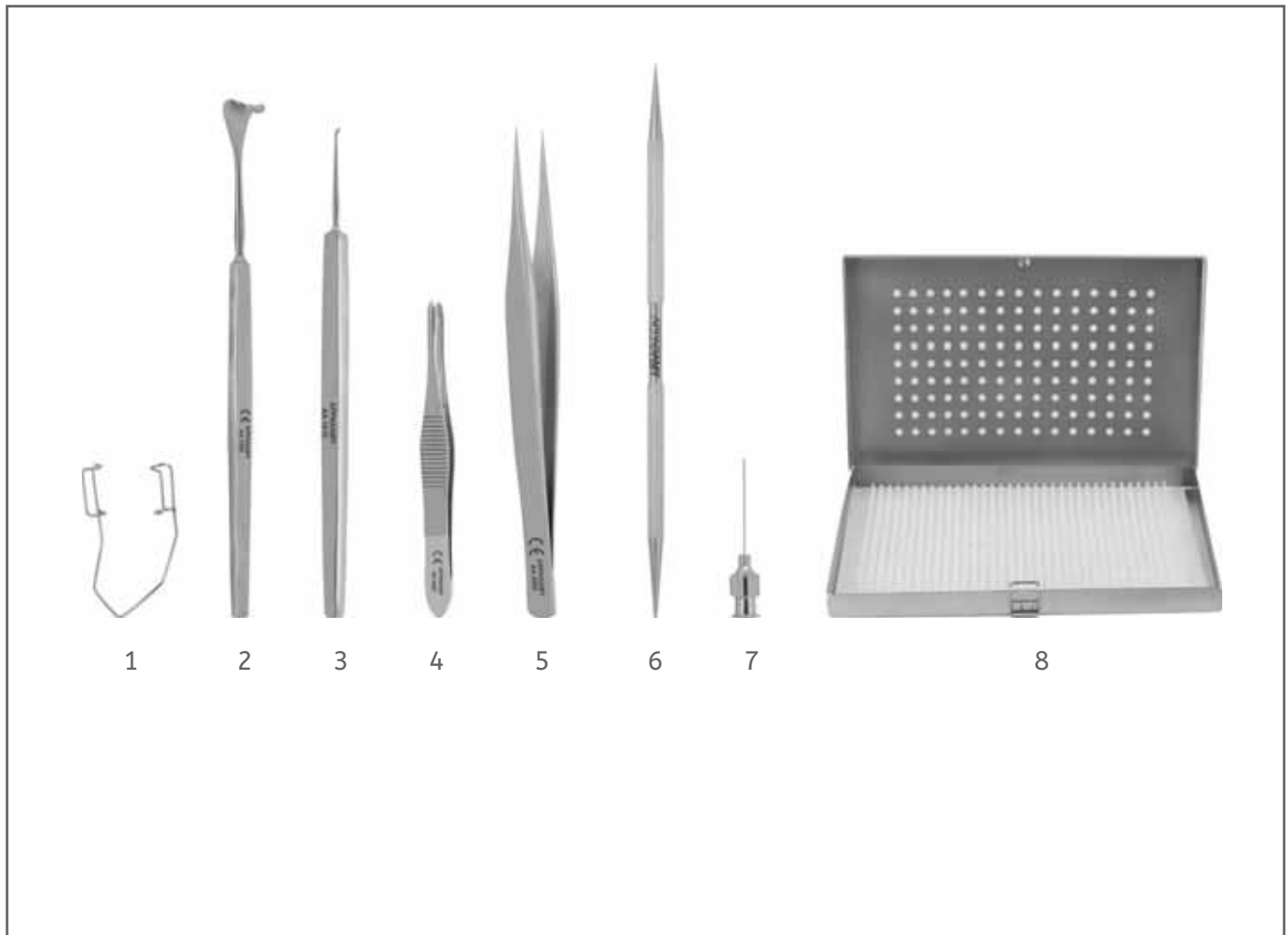

- 01. **AA 1009** Barraquer wire speculum, large
- 02. **AA 1262** Desmarres lid retractor size 2
- 03. **AA 1410** Golf club foreign body spud
- 04. **AA 3485** Beer cilia forceps
- 05. **AA 3885** Jewelers forceps standard
- 06. **AA 6440** Castroviejo lacrimal dilator (double end)
- 07. **AA 7010** Lacrimal cannula, 23 G, straight
- 08. **AA 8005** Sterilization box with silicone mat

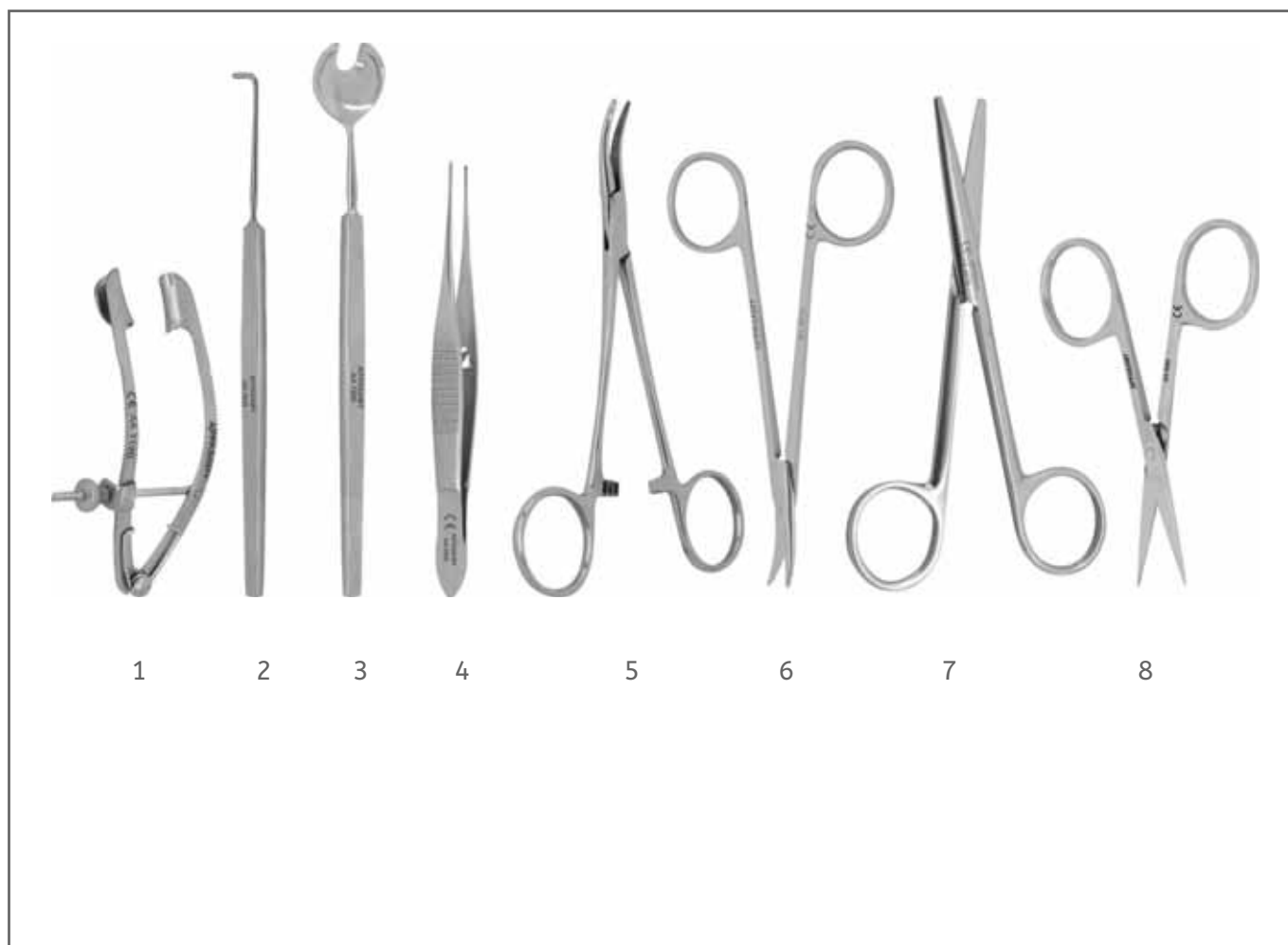

1. **AA 1120** Lancaster eye speculum
2. **AA 1825** Graefe muscle hook size 1
3. **AA 1890** Wells Enucleation spoon
4. **AA 3305** Elschnig fixation forceps 1 x 2 angled teeth
5. **AA 3935** Halsted mosquito forceps curved
6. **AA 4535** Stevens tenotomy scissors curved
7. **AA 4575** Enucleation scissors (st)
8. **AA 4500** Iris scissors, straight

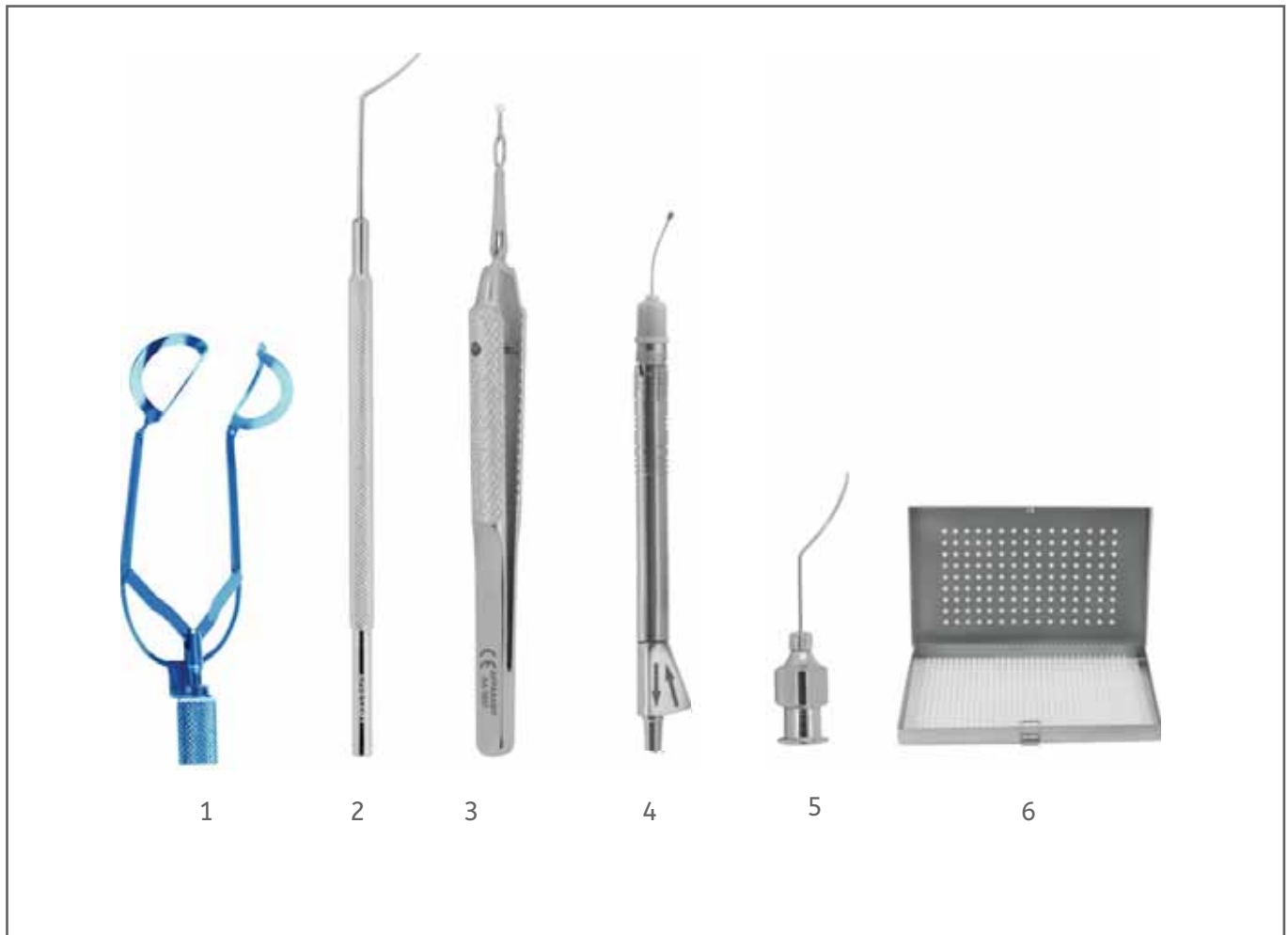

- 1. **AAT 1196** Jerome Bovert speculum reversible
- 2. **AA 1666** Slade femtosecond spatula
- 3. **AA 3907** Akahoshi Nucleus splitter forceps
- 4. **AAT 7393 / 7398A** I/A Probe - I/A Tip S-Curved, polished
- 5. **AA 7222** Slade femtosecond cannula
- 6. **AA 8005** Sterilization box with silicone mat

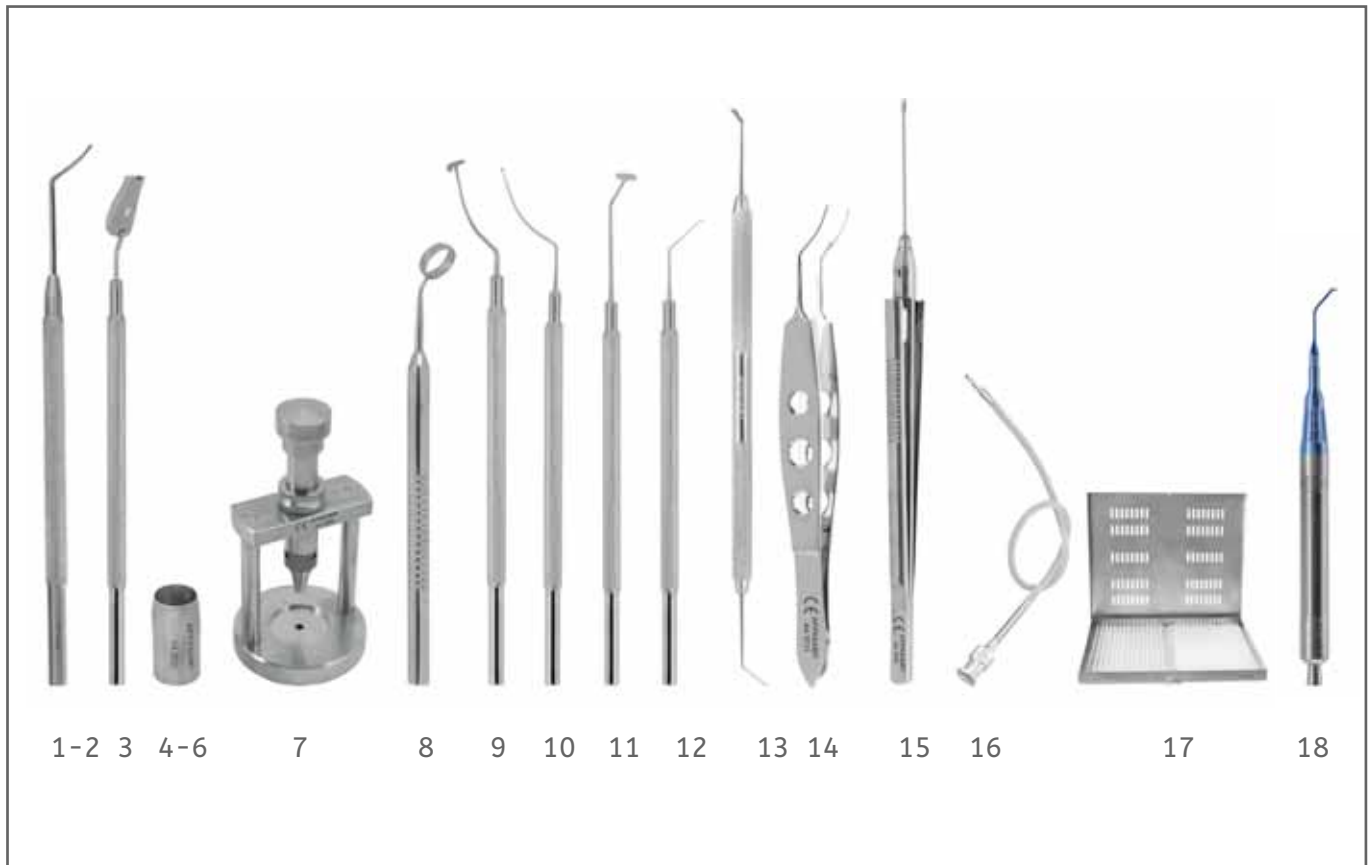

1. **AA 1398** Corneal dissector, straight blade
2. **AA 1399** Corneal dissector, vaulted blade
3. **AA 1696** Busin endothelial glide
4. **AA 2030** See through corneal trephine 8.5mm
5. **AA 2031** See through corneal trephine 9.0mm
6. **AA 2032** See through corneal trephine 9.5mm
7. **AA 2065** Corneal transplant punch
8. **AA 2249** Bores optic zone marker, 8.0mm
9. **AA 2500** DSAEK glider
10. **AA 2505** DSAEK stromal scrubber
11. **AA 2510** DSAEK descemet stripper
12. **AA 2515** Reverse sinskey hook
13. **AA 2530** Rosenwasser lamellar donor inserting shovel
14. **AA 3731** Donor lamellar inserting forceps
15. **AA 3990** Iridectomy forceps straight
16. **AA 7150** Lewicky A/C maintainer cannula
17. **AA 8020** Appasamy sterilization box with two silicone mats
18. **AAT 8325** Rosenwasser irrigating endothelial stripper

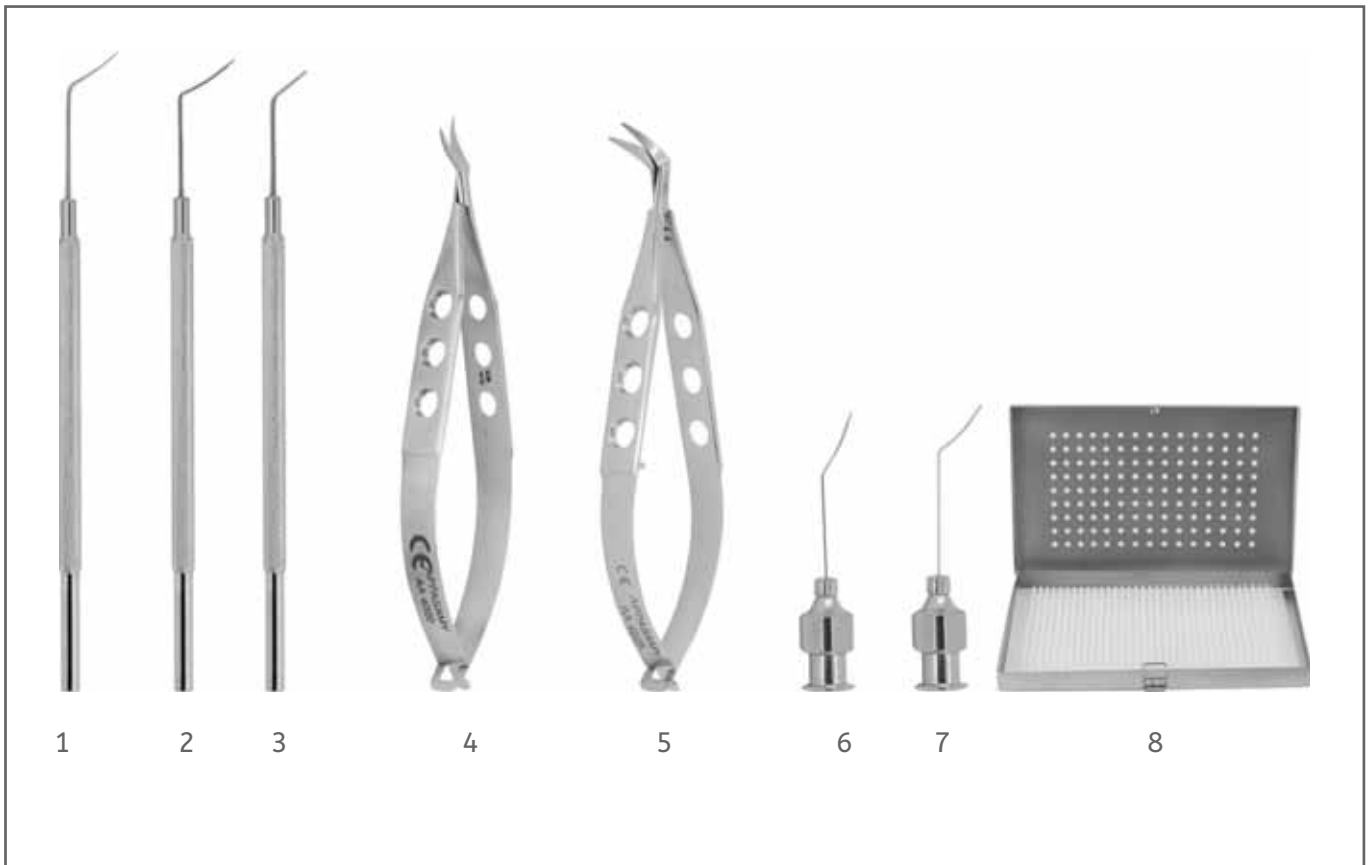

1. **AA 2555** DALK corneal dissector
2. **AA 2560** Rosenwasser DALK Trisector
3. **AA 2565** Bonfadini DALK spatula
4. **AA 4020** Katzin corneal transplant scissors, left
5. **AA 4025** Katzin corneal transplant scissors, right
6. **AA 7050** Rosenwasser DALK cannula, 27 G
7. **AA 7100** DALK air injection cannula, 27 G
8. **AA 8005** Sterilization box with silicone mat

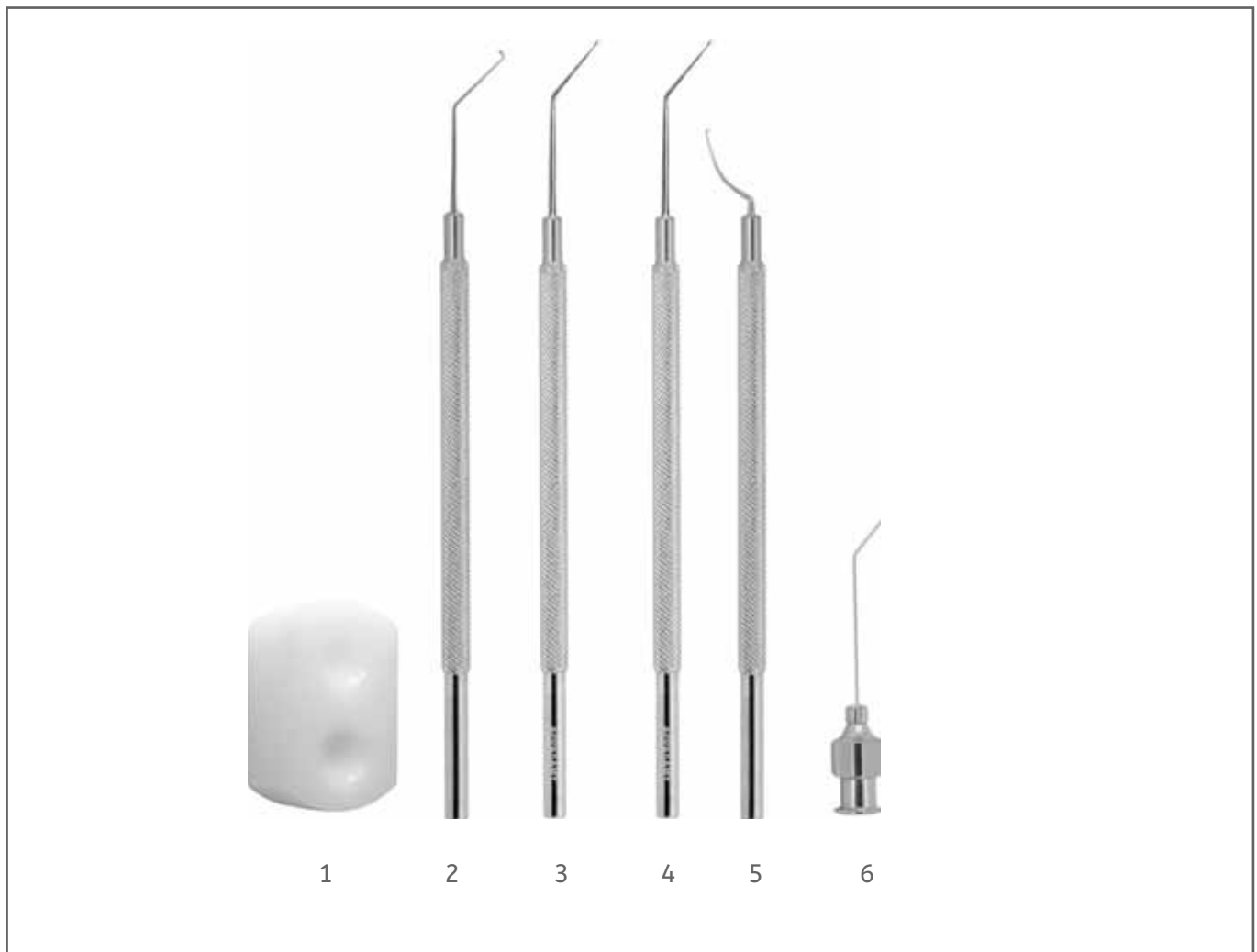

1. **AA 2062** DMEK twin block
2. **AA 2535** DMEK rake
3. **AA 2540** DMEK large crystal spatula
4. **AA 2545** DMEK small crystal spatula
5. **AA 2550** Dexatome DMEK/DSAEK spatula
6. **AA 7116** DMEK cannula 23 G

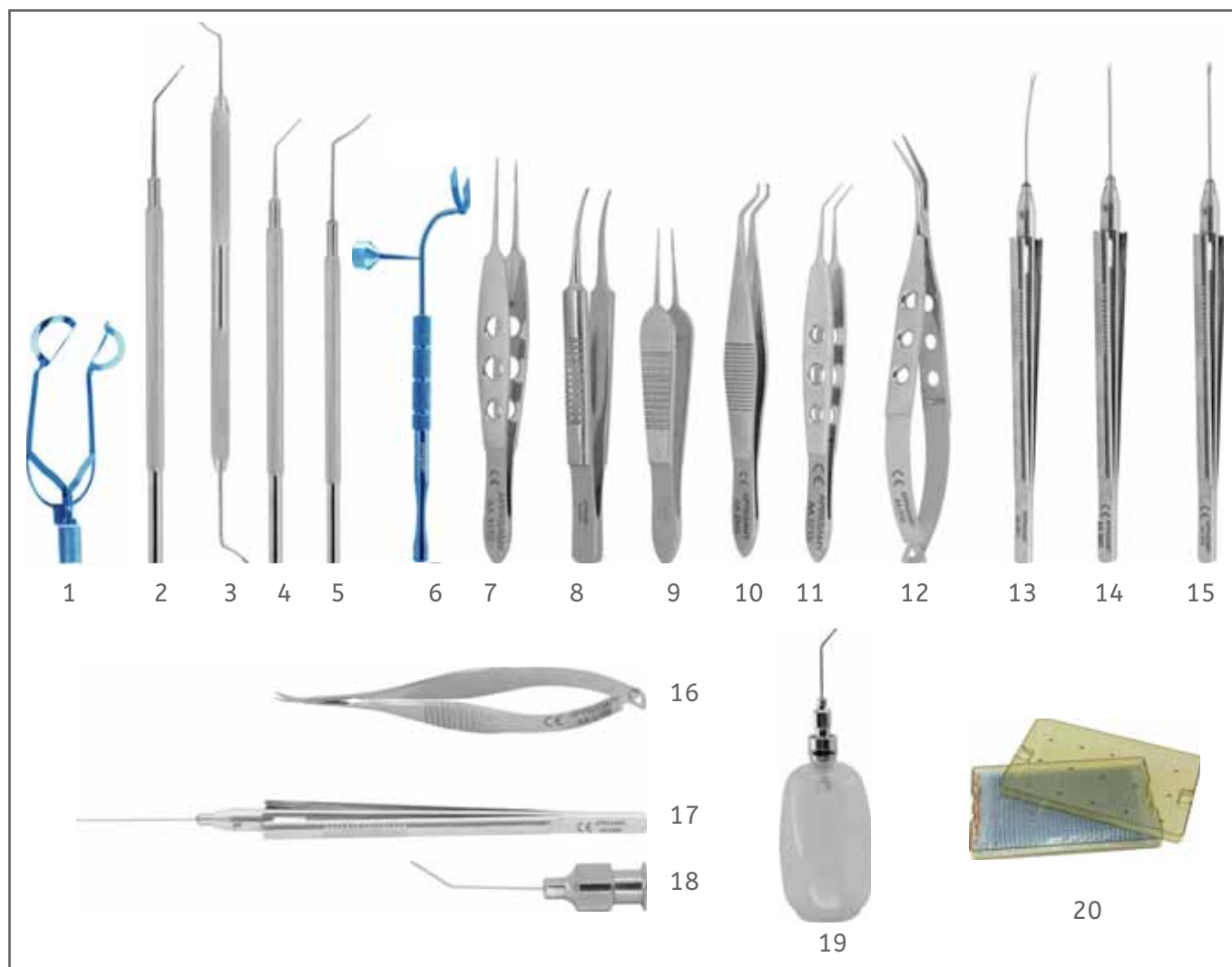

1. **AAT 1196** Jerome Bovert speculum reversible
2. **AA 1478** Toric lens manipulator
3. **AA 1481** Zaldivar lens manipulator
4. **AA 1613** Pisacano hook horizontal
5. **AA 1655** Barraquer Iris spatula, 0.25mm, angled.
6. **AAT 2800** LRI slit lamp marker
7. **AA 3170** Bonn forceps, long model, 0.12mm, 1 x 2 teeth
8. **AA 3270** Kirby Iris forceps, curved, 1.5mm, 1 x 2 teeth
9. **AA 3275** St.Martin suturing forceps, 1 x 2 teeth
10. **AA 3340** Dastoor superior rectus forceps, 1 x 2 teeth
11. **AA 3715** Faulkner lens holding forceps
12. **AA 3721** DSEK inserting forceps
13. **AA 3871** Kreshner micro incision capsulorhexis forceps, curved 20 G
14. **AA 3987** Lens cartridge loading forceps, straight 20 G
15. **AA 3990** Iridectomy forceps
16. **AA 4255** Vannas capsulotomy scissors, curved
17. **AA 4460** Viterous scissors 20 G, 30° angled jaws
18. **AA 7207** Pearce hydro dissection cannula, 35° angled 27 G
19. **AA 7830** Silicone bulb with adaptor
20. **AA 8200** Plastic sterilization box with silicone mat

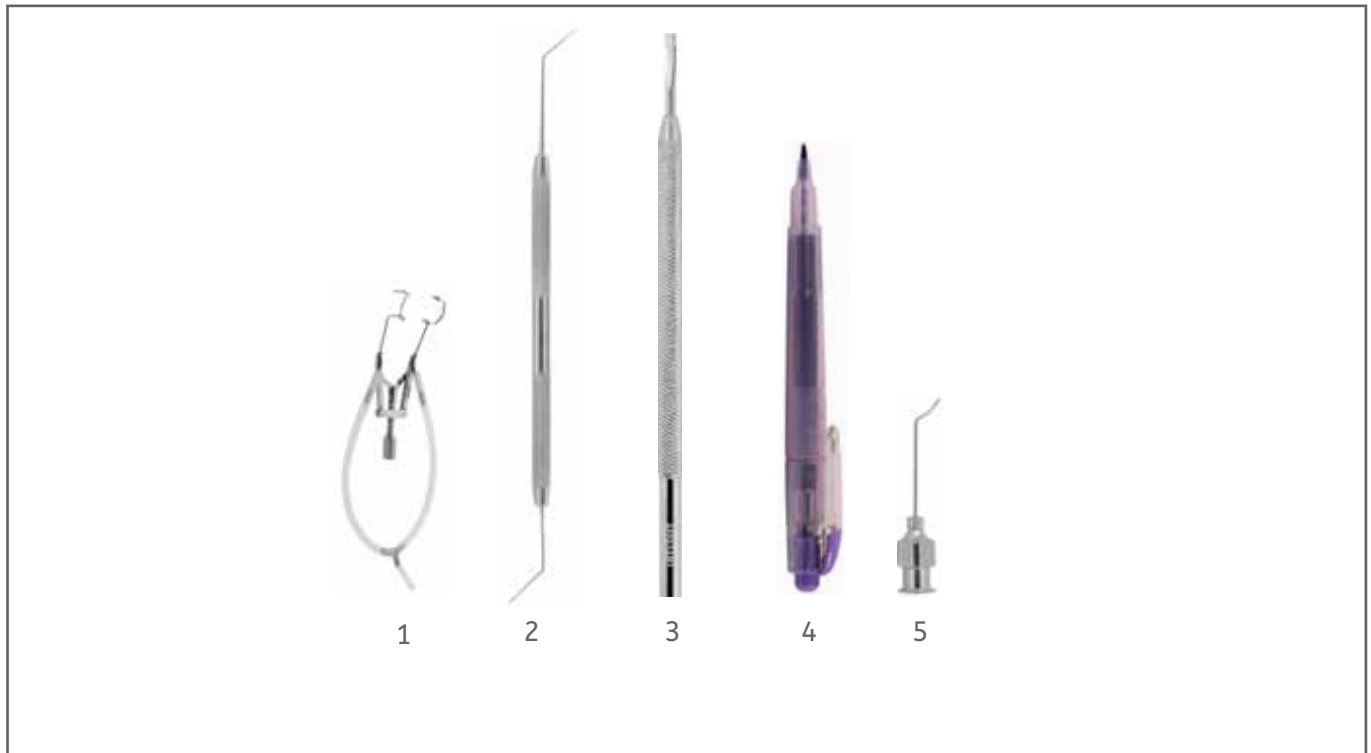

- 01. **AA 1088** Lieberman aspirating speculum, temporal
- 02. **AA 1639** LASIK flap lifter
- 03. **AA 2136** Grandon T-Incision marker, size 2.5mm wide
- 04. **AA 2300** Marking pen, fine tip
- 05. **AA 7870** Nichamin LASIK irrigating cannula, 6mm, 23 G

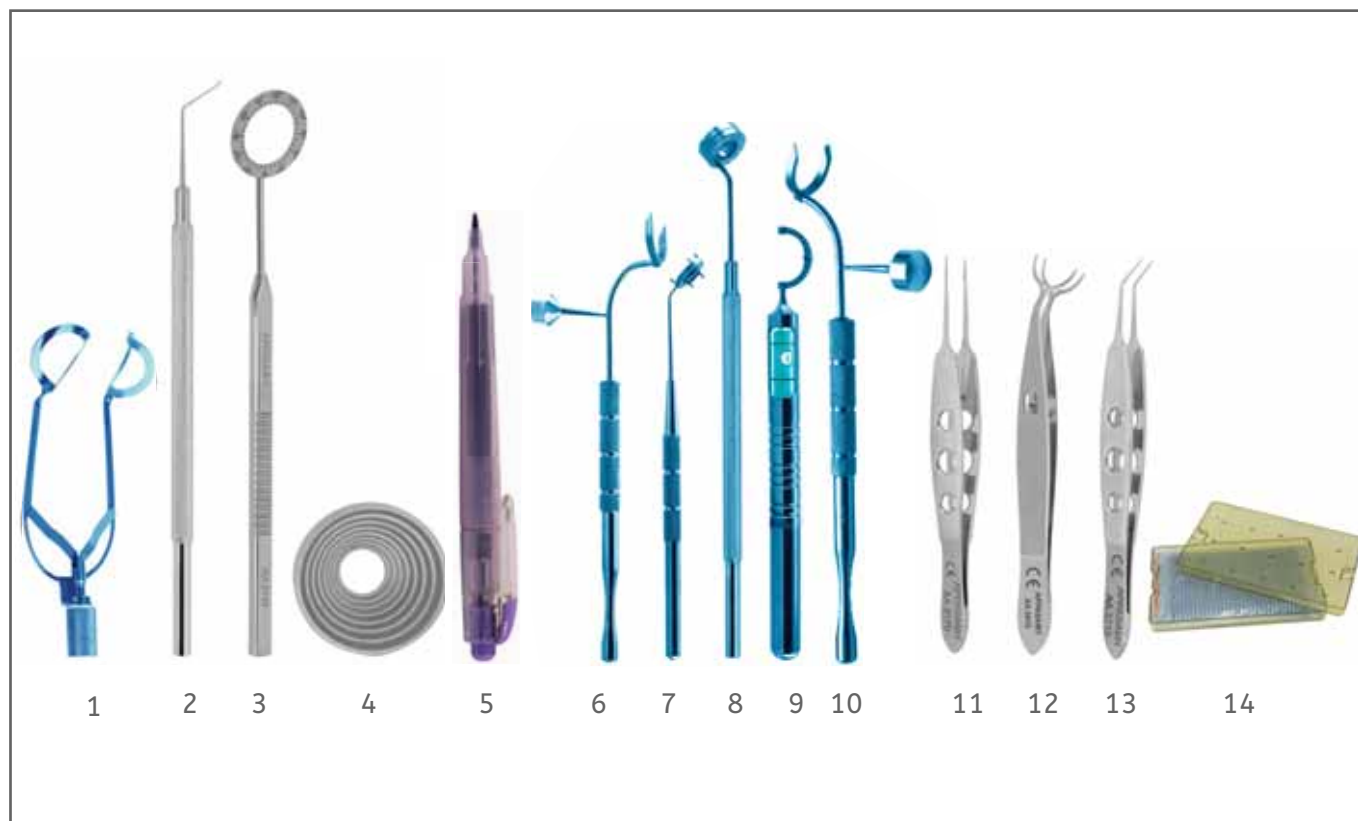

1. **AAT 1196** Jerome Bovert speculum reversible
2. **AA 1485** Bahr-Maltzman no hole IOL manipulating hook
3. **AA 2140** Mendez degree gauge
4. **AA 2183** Maloney intra-operative keratometer
5. **AA 2300** Marking pen, fine tip
6. **AAT 2800** LRI slit lamp marker
7. **AAT 2820** LRI marker, 6mm & 8mm chord lengths
8. **AAT 2825** LRI marker, 40-60-80 degree
9. **AAT 2830** Pre-op Toric reference marker with bubble level
10. **AAT 2840** LRI axis marker
11. **AA 3170** Bonn forceps, long model, 0.12mm, 1 x 2 teeth
12. **AA 3415** Kremer corneal fixation forceps, curved
13. **AA 3715** Faulkner lens holding forceps
14. **AA 8200** Plastic sterilization box with silicone mat

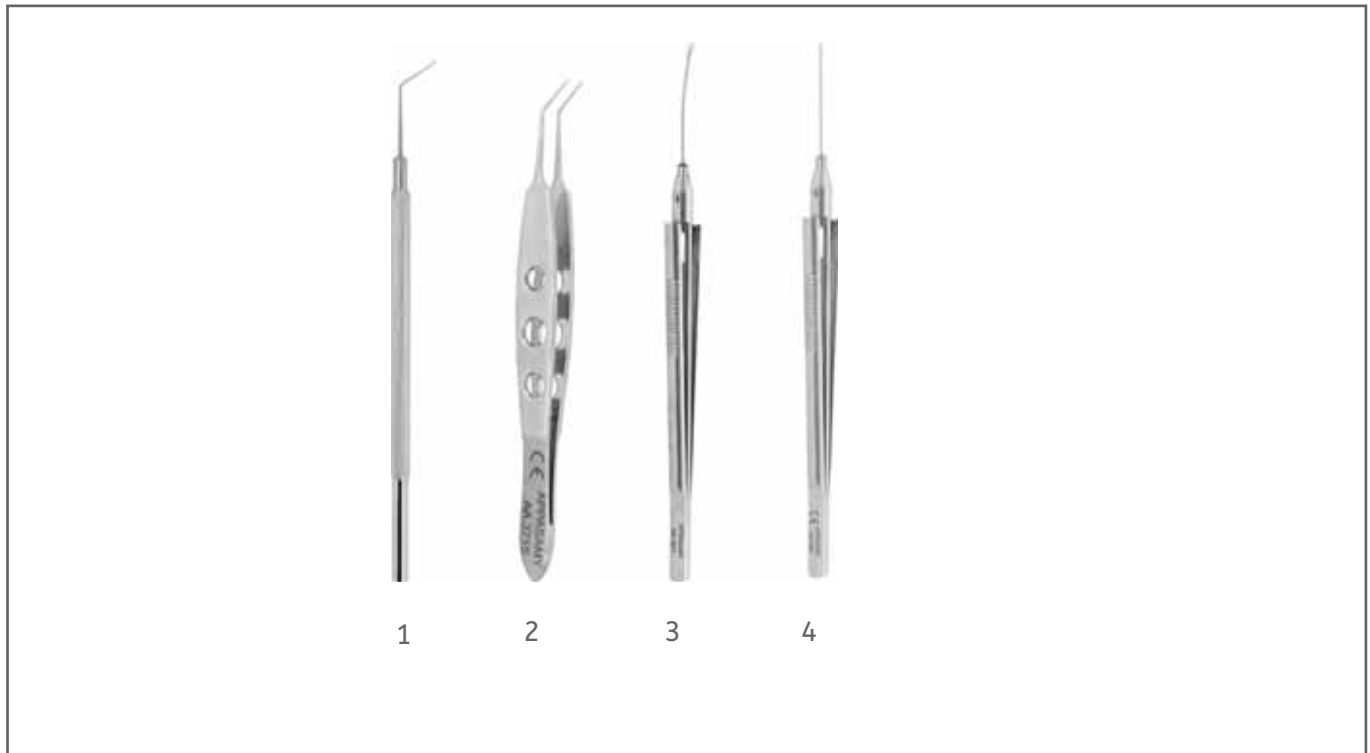

- 01. **AA 1485** Bahr-Maltzman no hole IOL manipulating hook
- 02. **AA 3715** Faulkner lens holding forceps
- 03. **AA 3871** Kreshner micro incision capsulorhexis forceps, curved 20 G
- 04. **AA 4460** Viterous scissors 20 G, 30° angled jaws

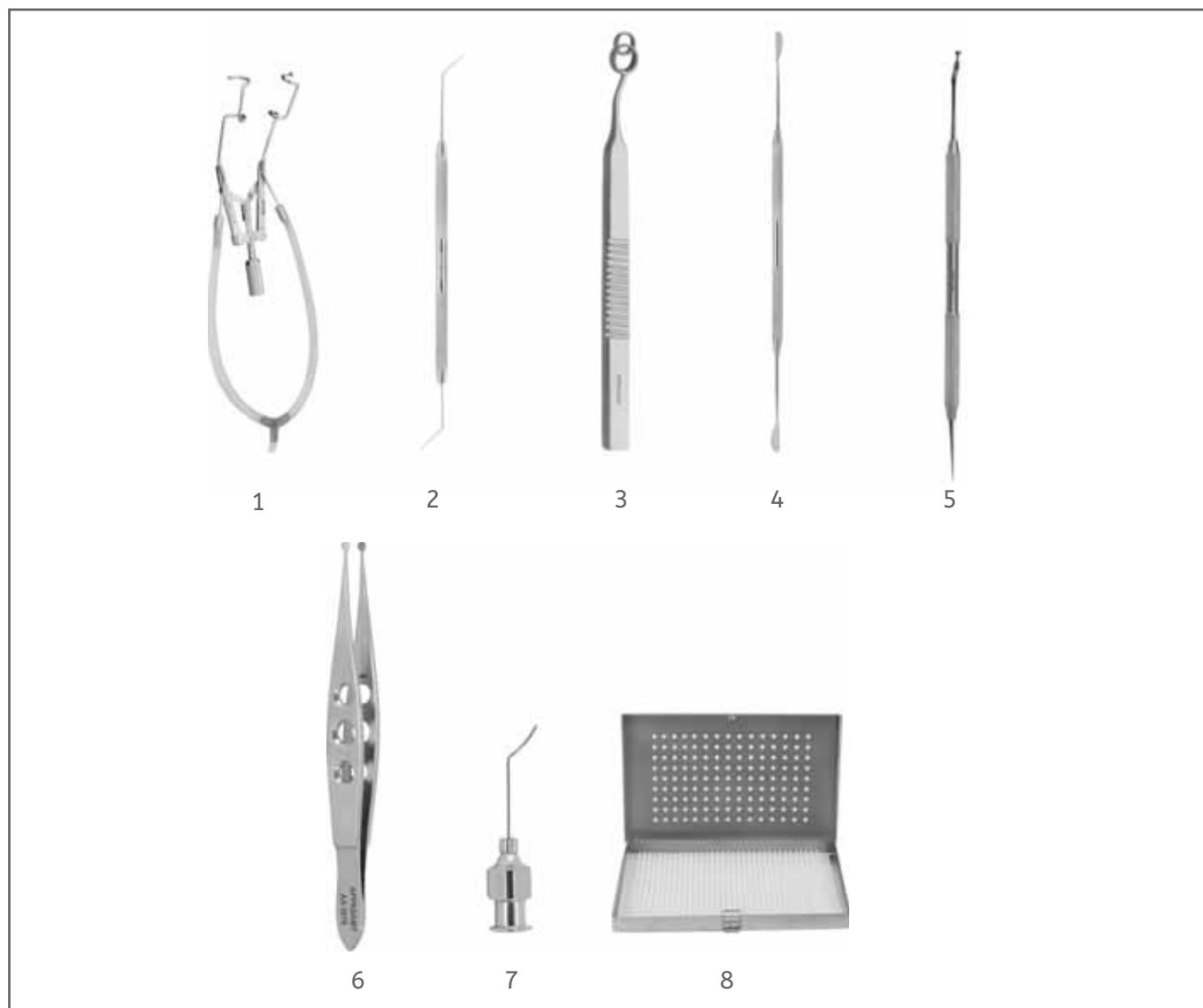

- 01. **AA 1086** Lieberman irrigating speculum, temporal
- 02. **AA 1639** LASIK flap lifter
- 03. **AA 2157** Corneal marker
- 04. **AA 2625** Buratto LASIK flap protector
- 05. **AA 2650** Thorlakson LASIK flap lifter
- 06. **AA 3876** Buratto LASIK flap forceps
- 07. **AA 7885** Buratto LASIK cannula 23 G
- 08. **AA 8005** Sterilization box with silicone mat

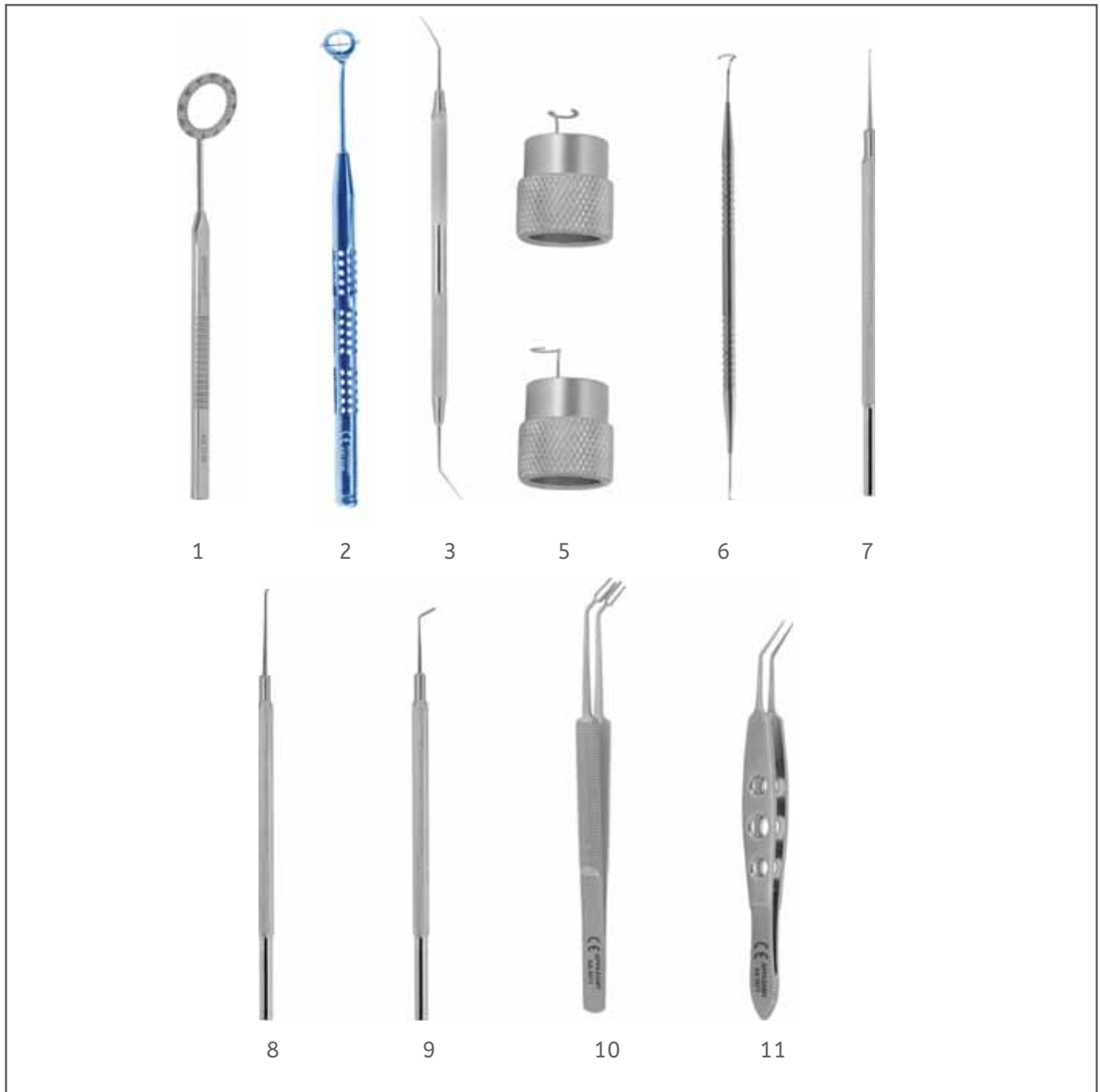

- 01. **AA 2140** Mendez degree gauge
- 02. **AAT 2146** Tunnel zone marker
- 03. **AA 2221** Optical zone marker
- 04. **AA 2432** ICSR tunnel marker left
- 05. **AA 2433** ICSR tunnel marker right
- 06. **AA 2434** ICSR tunnel marker double ended
- 07. **AA 2516** Elevator for ICSR implantation
- 08. **AA 2517** Suarez spreader
- 09. **AA 2518** Bicalto guide
- 10. **AA 3411** Nevyas-Wallace fixation forceps
- 11. **AA 3671** Forceps for ICSR implant



- 01.**AA 1481** Zaldiver lens Manipulator double ended
- 02.**AA 1482** Pallikaris lens manipulator
- 03.**AA 2286** Henderson alignment marker
- 04.**AA 2140** Mendez degree gauge
- 05.**AA 2288** Henderson Toric IOL marker
- 06.**AA 2300** Marking pen, fine tip
- 07.**AAT 2805** White house gravity axis marker II
- 08.**AAT 2815** Toric IOL combo marker
- 09.**AAT 2820** LRI marker 6 & 8mm chord length
- 10.**AAT 2825** LRI marker 40-60-80 degree
- 11.**AAT 2830** Pre-op Toric reference marker, with bubble level
- 12.**AA 7621** Henderson MICS capsule polisher, 23 g
- 13.**AA 8200** Plastic sterilization box with silicone mat

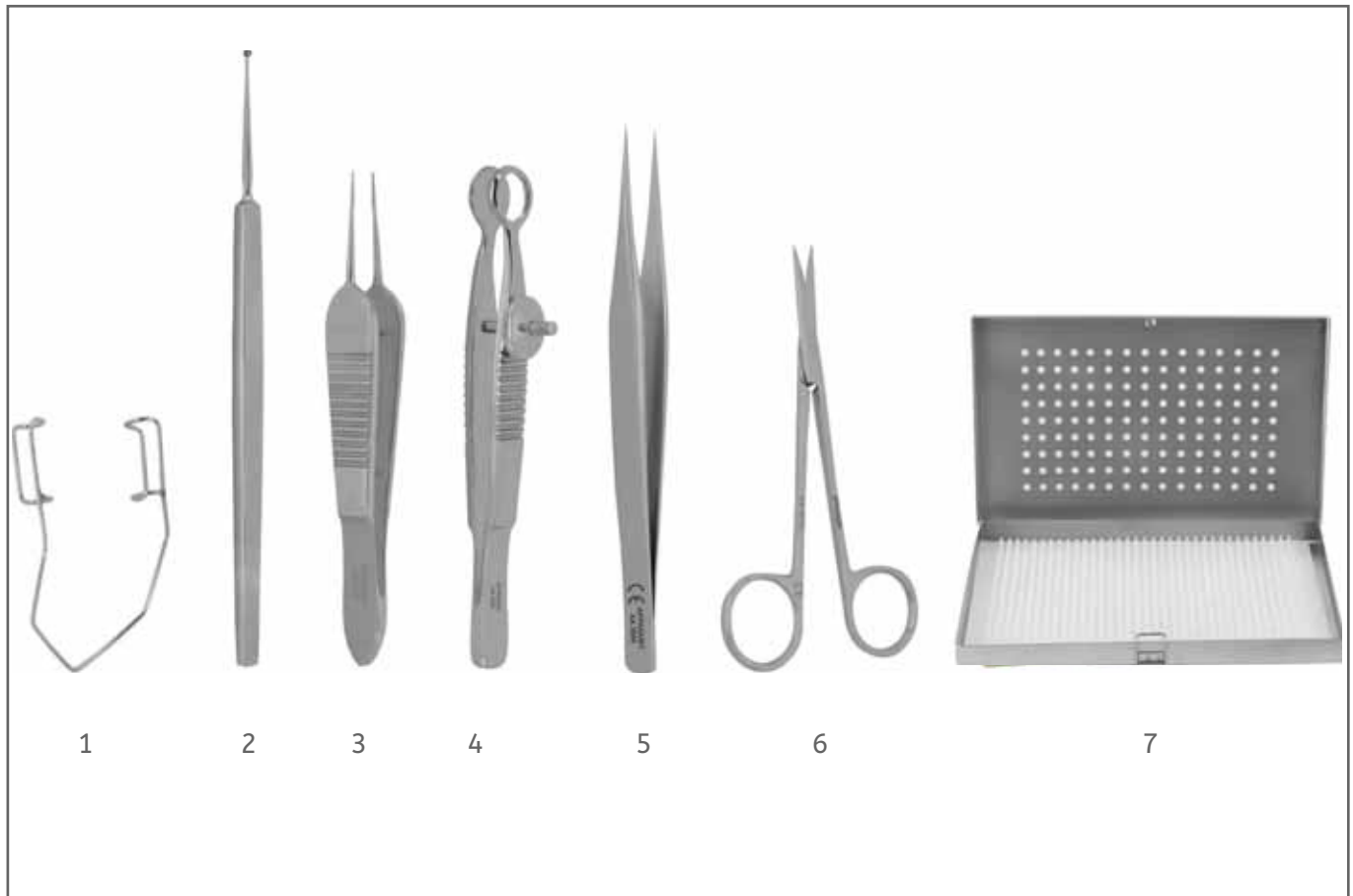

1. **AA 1009** Barraquer wire speculum, large
2. **AA 1875** Meyerhoefer chalazion curette, size 0
3. **AA 3275** St.Martin suturing forceps, 1 x 2 teeth
4. **AA 3620** Lambert chalazion forceps
5. **AA 3885** Jewelers forceps
6. **AA 4510** Eye scissors, 4.5" length
7. **AA 8005** Sterilization box with silicone mat

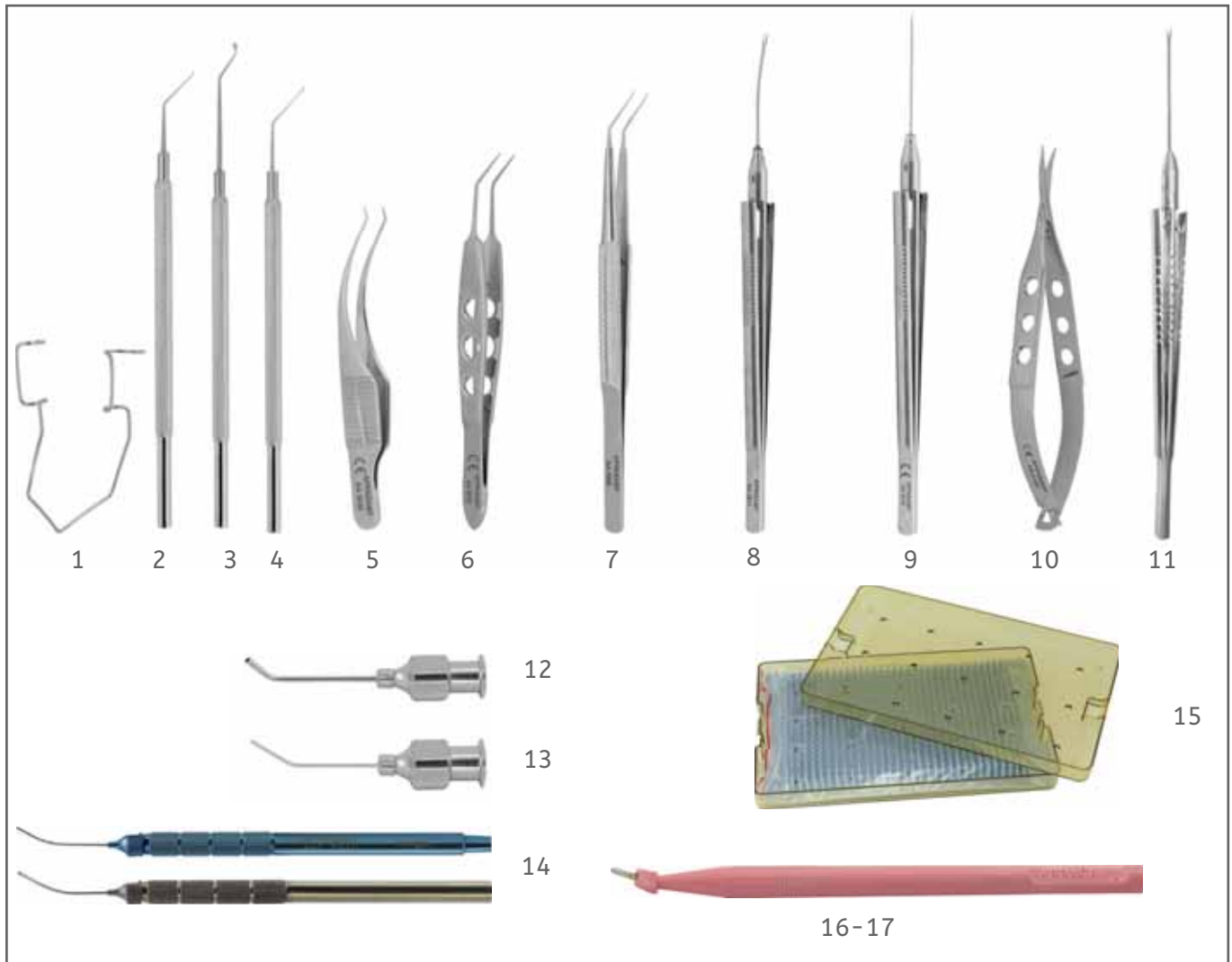

1. **AA 1025** Kratz-Barraquer wire speculum, big
2. **AA 1465** Sinsky II lens manipulating hook angled
3. **AA 1597A** Akahoshi nucleus ring sustainer
4. **AA 1993** Agarwal phaco chopper 1mm fully cutting edge
5. **AA 3030** Colibri forceps 1 x 2 teeth 0.12mm
6. **AA 3805** McPherson IOL forceps, 11mm angled
7. **AA 3868** Utrata capsulorhexis forceps, round handle, extra delicate
8. **AA 3872** Kreshner micro incision capsulorhexis forceps, curved 23 G
9. **AA 3918** Akahoshi super combo prechopper
10. **AA 4155** Westcott tenotomy scissors
11. **AA 4455** Vitreous scissors curved, 20 G
12. **AA 7105** Rycroft air injection cannula, 23 G
13. **AA 7205** Pearce hydrodissection cannula, 25 G
14. **AAT 7410/11** I/A Bimanual set
15. **AA 8200** Plastic sterilization box with silicone mat
16. **AA 572014** Ultra thin phaconit knife, 1.4mm
17. **AA 572018** Ultra thin phaconit knife, 1.8mm

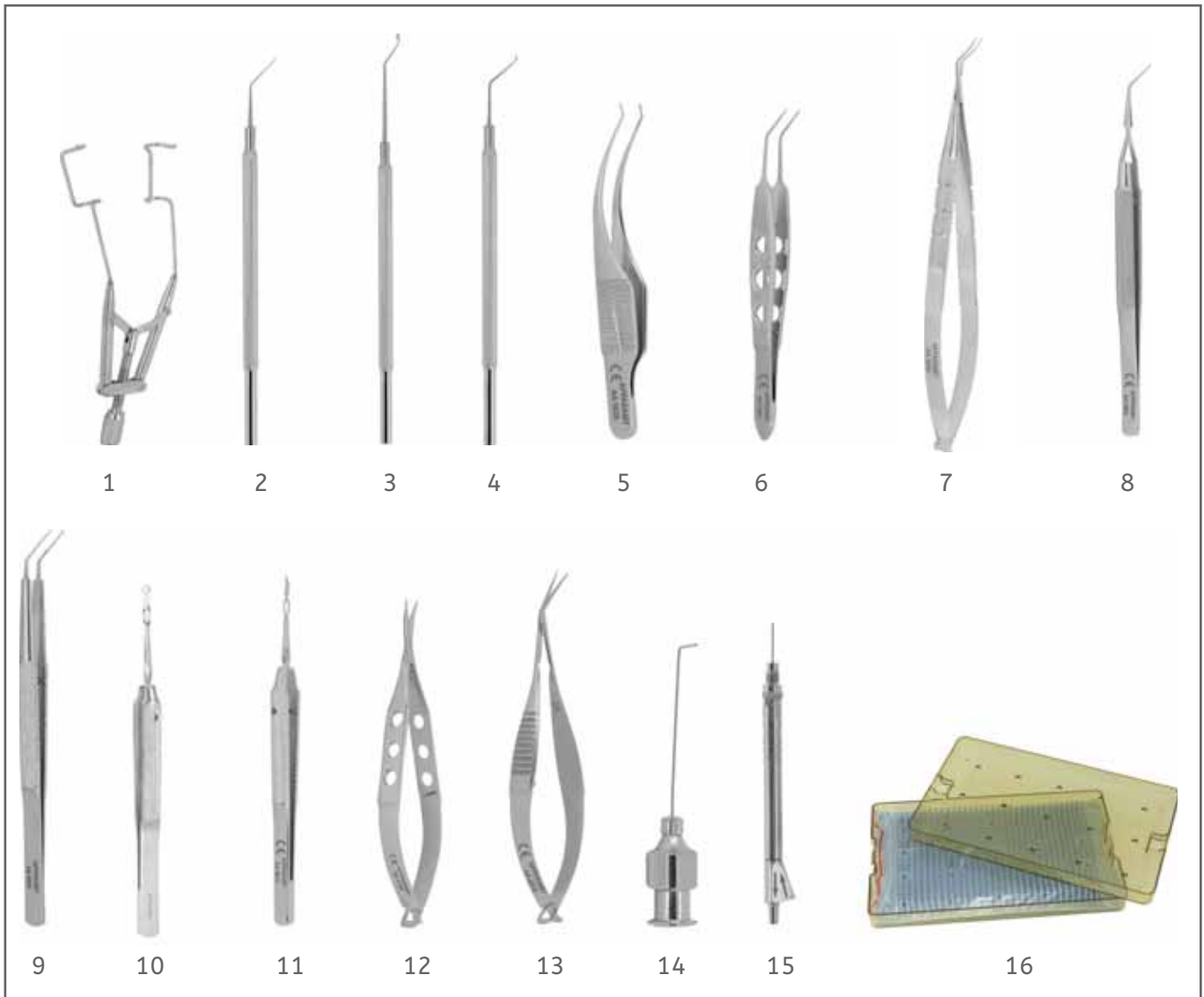

- 01. **AA 1184** Lieberman temporal speculum
- 02. **AA 1465** Sinsky II lens manipulating hook angled
- 03. **AA 1597A** Akahoshi nucleus ring sustainer
- 04. **AA 2000** Nagahara karate chopper straight
- 05. **AA 3030** Colibri forceps 1 x 2 teeth 0.12mm
- 06. **AA 3805** McPherson IOL forceps, 11mm angled
- 07. **AA 3856** Inamura capsulorhexis forceps
- 08. **AA 3860** Akahoshi capsulorhexis cross action forceps
- 09. **AA 3864** Giannetti capsulorhexis forceps
- 10. **AA 3907** Akahoshi nucleus splitter forceps
- 11. **AA 3913B** Akahoshi combo pre chopper
- 12. **AA 4155** Westcott tenotomy scissors
- 13. **AA 4275** Vannas capsulotomy scissors angle forward 11mm
- 14. **AA 7295** Akahoshi hydrodissection cannula 27 G
- 15. **AAT 7393/94** I/A Probe set with straight silicone sleeve tip, 19 G
- 16. **AA 8200** Plastic sterilization box with silicone mat

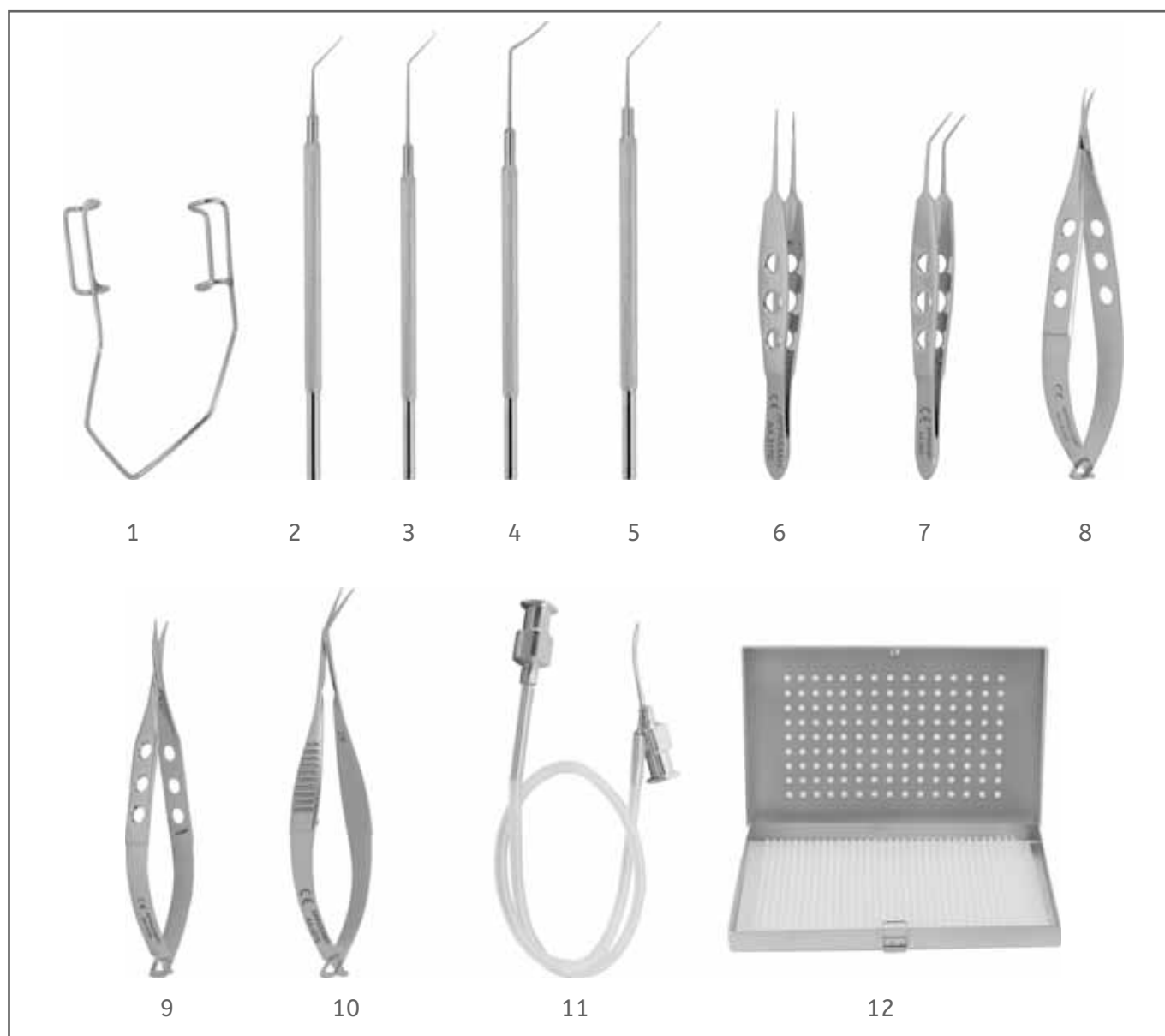

- 01. **AA 1009** Barraquer wire speculum, large
- 02. **AA 1465** Sinsky II lens manipulating hook angled
- 03. **AA 1597** Akahoshi nucleus ball sustainer
- 04. **AA 1655** Barraquer Iris spatula 0.25mm, angled
- 05. **AA 1993** Agarwal phaco chopper 1mm fully cutting edge
- 06. **AA 3170** Bonn forceps long model 0.12mm, 1 x 2 teeth
- 07. **AA 3805** McPherson IOL forceps, 11mm angled
- 08. **AA 4040** Castroviejo corneal scissors small blades
- 09. **AA 4155** Westcott tenotomy scissors
- 10. **AA 4275** Vannas capsulotomy scissors angle forward 11mm
- 11. **AA 7420** Simcoe I/A cannula 23 G direct
- 12. **AA 8005** Sterilization box with silicone mat

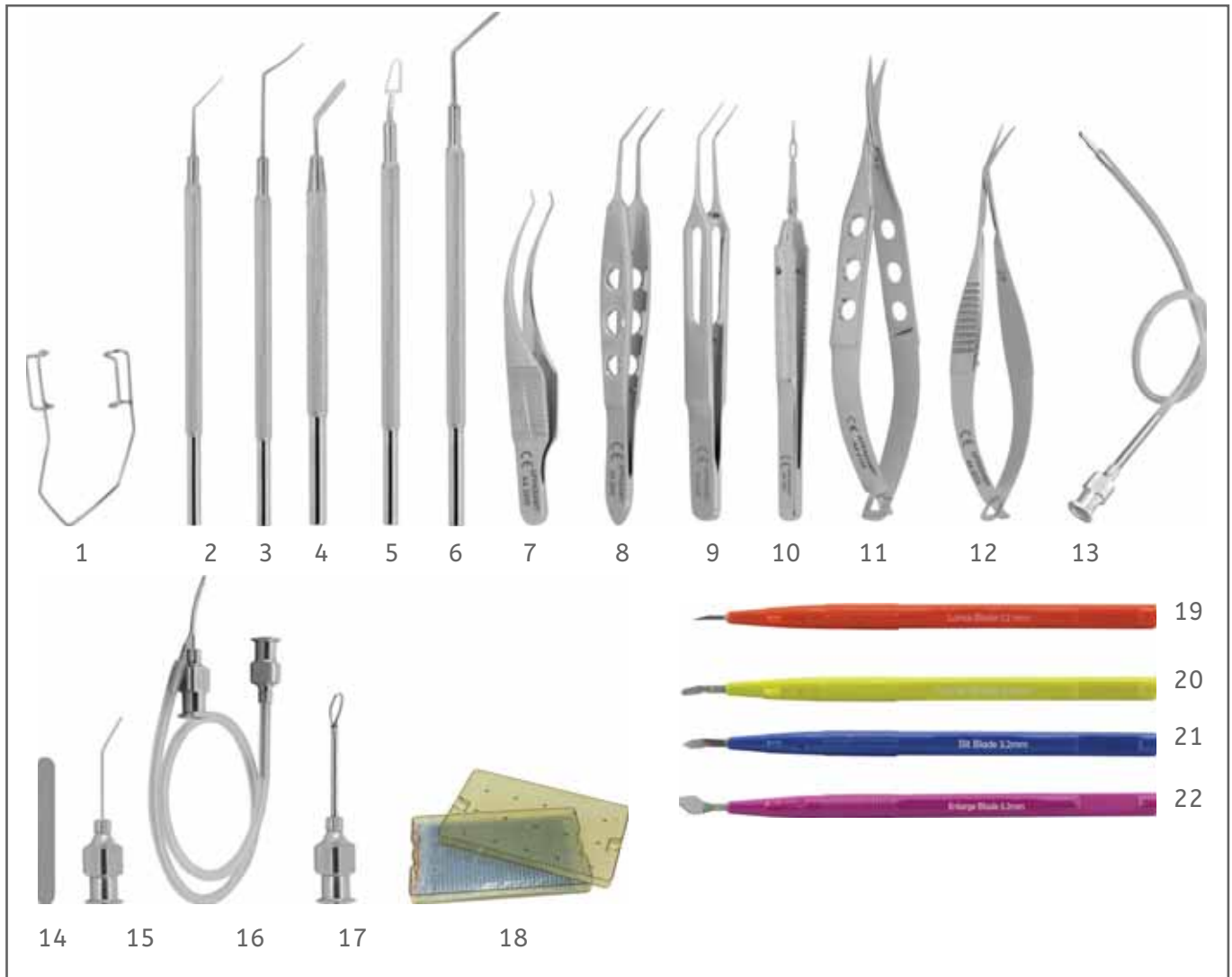

1. **AA 1009** Barraquer wire speculum, large
2. **AA 1465** Sinsky II lens manipulating hook angled
3. **AA 1655** Barraquer Iris spatula, 0.25mm, angled
4. **AA 1965** Kansas nucleus bisector
5. **AA 1970** Kansas nucleus trisector
6. **AA 1975** Kansas nucleus vectis solid, right
7. **AA 3030** Colibri forceps 1 x 2 teeth 0.12mm
8. **AA 3805** McPherson IOL forceps, 11mm angled
9. **AA 3855** Utrata capsulorhexis forceps, long straight shanks, flat handle
10. **AA 3907** Akahoshi nucleus splitter forceps
11. **AA 4155** Westcott tenotomy scissors
12. **AA 4275** Vannas capsulotomy scissors angle forward 11mm
13. **AA 7150** Lewicky A/C maintainer
14. **AA 7202** IOL glide, silicone
15. **AA 7205** Pearce hydrodissection cannula, 25 G
16. **AA 7447** Ruit irrigating/aspirating cannula, 23 G
17. **AA 7705** Knolle-Pearce irrigating vectis, 4mm wide, 7mm long loop
18. **AA 8200** Plastic sterilization box with silicone mat
19. **AA 560012** Lance knife (side port blade), 1.2mm
20. **AA 561021** Tunnel knife (crescent blade), 2.1mm
21. **AA 562032** Slit knife (Entry Keratome blade), 3.2mm
22. **AA 563052** Slit enlarge knife (IOL implant blade), 5.2mm

AA - Stainless Steel, AAT - Titanium

Titanium Surgery Set

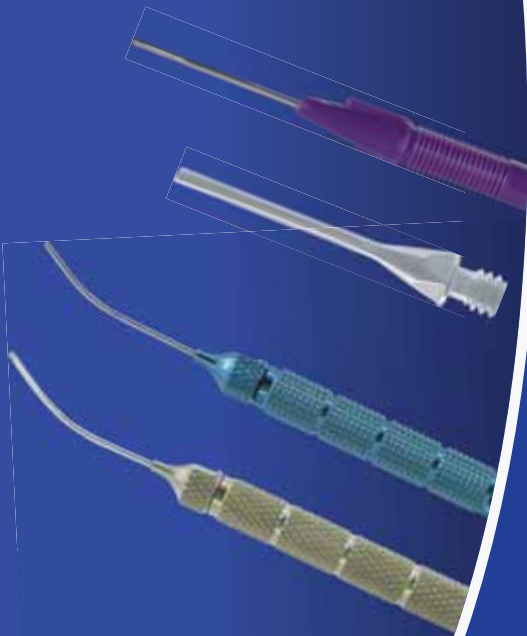

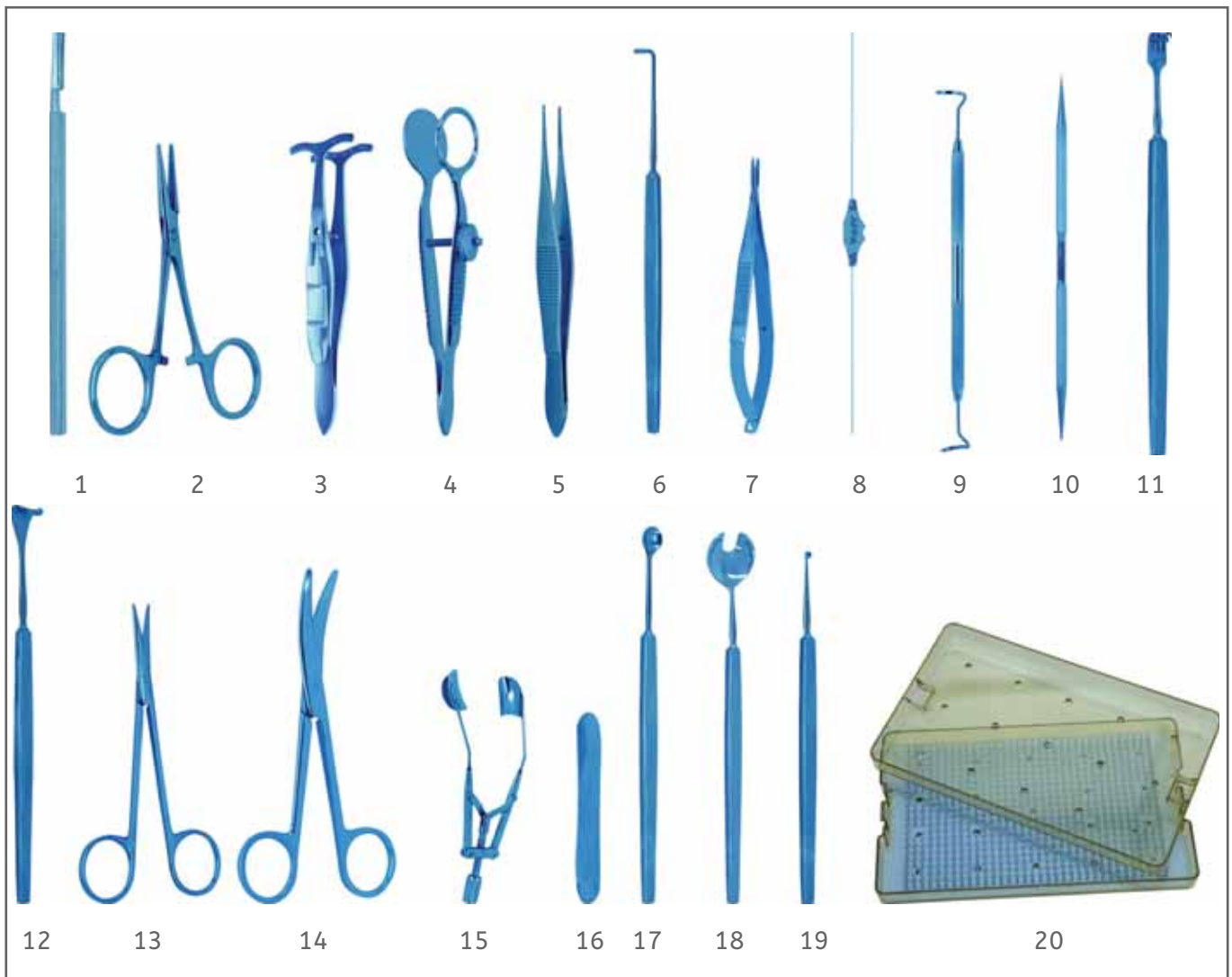

1. **AAT 5465** Bard-Parker handle #3 round handle
2. **AAT 3920** Hartman mosquito forceps straight
3. **AAT 3631** Putterman type Lid clamp
4. **AAT 3628** Desmarres chalazion forceps
5. **AAT 3300** Fixation forceps 1 x 2 teeth
6. **AAT 1826** Graefe muscle hook size 2
7. **AAT 5065** Castroviejo needle holder
8. **AAT 6175** Bowman lacrimal probe,
9. **AAT 6150** Pigtail probe with suture holes
10. **AAT 6440** Lacrimal dilator double-end
11. **AAT 1225** Knapp lacrimal sac retractor sharp
12. **AAT 1262** Desmarres Lid retractor solid blades size 2, straight
13. **AAT 4530** Stevens tenotomy scissors blunt tips, ring handle straight
14. **AAT 4580** Enucleation scissors ring handle medium curve
15. **AAT 1187** Lieberman - Tennant eye speculum
16. **AAT 1740** Jaeger Lid plate
17. **AAT 1880** Bunge evisceration spoon small
18. **AAT 1890** Enucleation spoon
19. **AAT 1877** Meyerhoefer chalazion curette size 2
20. **AA 8200** Plastic sterilization box with silicone mat

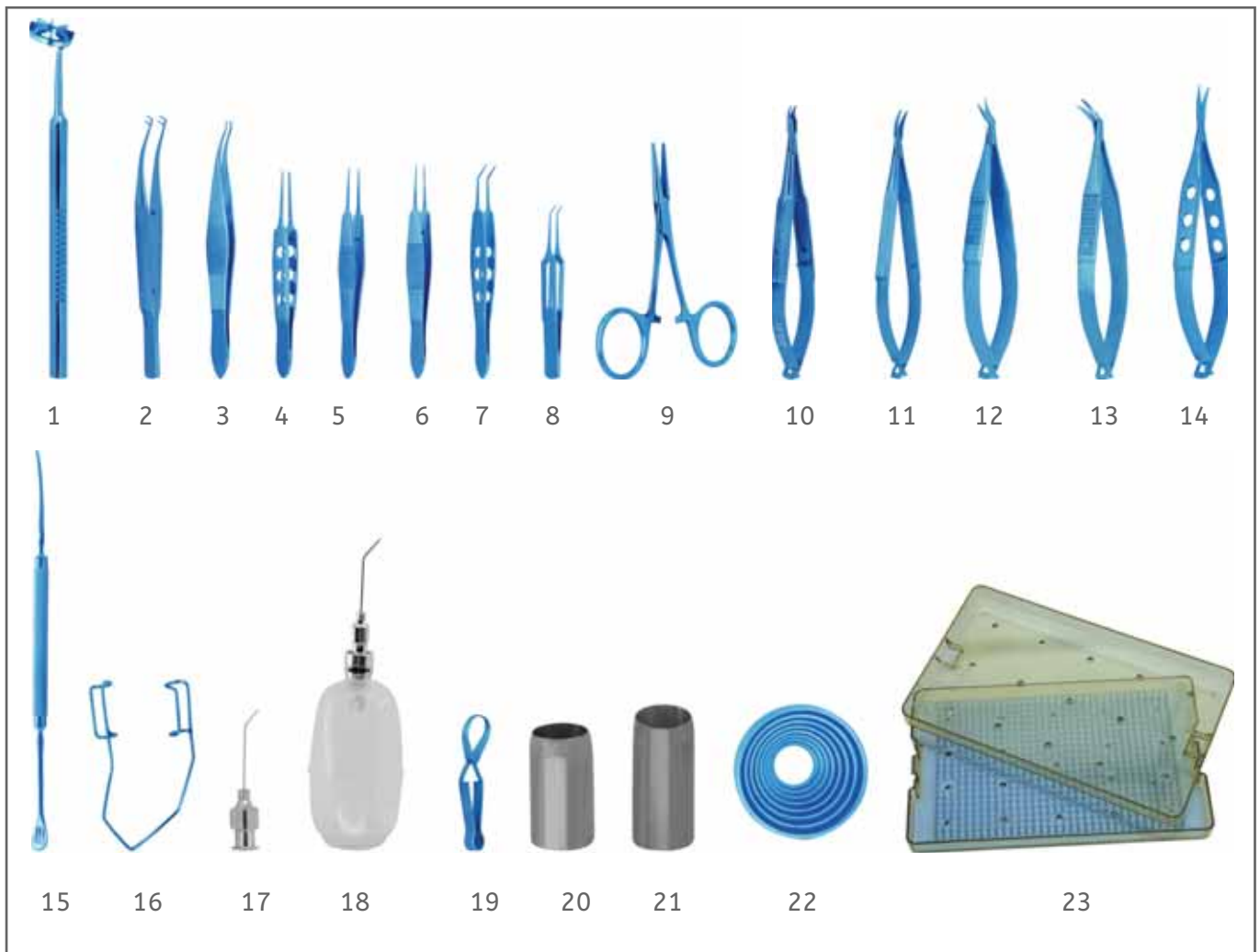

1. **AAT 2270** Anis suture placement marker
2. **AAT 3056** Polack double corneal forceps for corneal suturing
3. **AAT 3130** Castroviejo colibri forceps very delicate, 1 x 2 teeth
4. **AAT 3250** Bishop-Harmon tissue forceps 1 x 2 teeth
5. **AAT 3180** Castroviejo suturing forceps 1 x 2 teeth, 0.12mm
6. **AAT 3185** Castroviejo suturing forceps 1 x 2 teeth, 0.3mm
7. **AAT 3800** Kelman-McPherson forceps 7.5mm angle long handle
8. **AAT 3795** McPherson tying forceps smooth jaws long handle, 5mm angled
9. **AAT 3920** Hartman mosquito forceps straight
10. **AAT 5145** Barraquer N.Holder short model micro jaws, without lock
11. **AAT 5165** Barraquer needle holder very delicate jaws
12. **AAT 4010** Castroviejo corneoscleral scissors[s] blade left
13. **AAT 4015** Castroviejo corneoscleral scissors [s] blade right
14. **AAT 4155** Westcott tenotomy scissors
15. **AAT 1710** Paton spatula & spoon
16. **AAT 1009** Barraquer wire speculum, large
17. **AA 7105** Rycroft air injection cannula, 23 G
18. **AA 7830** Silicone bulb with adaptor
19. **AAT 3945** Baby Jones towel clamp
20. **AA 2028** Appasamy corneal trephine size 7.5mm Dia
21. **AA 2029** Appasamy corneal trephine size 8mm Dia
22. **AAT 2183** Maloney intra-operative keratometer
23. **AA 8200** Plastic sterilization box with silicone mat

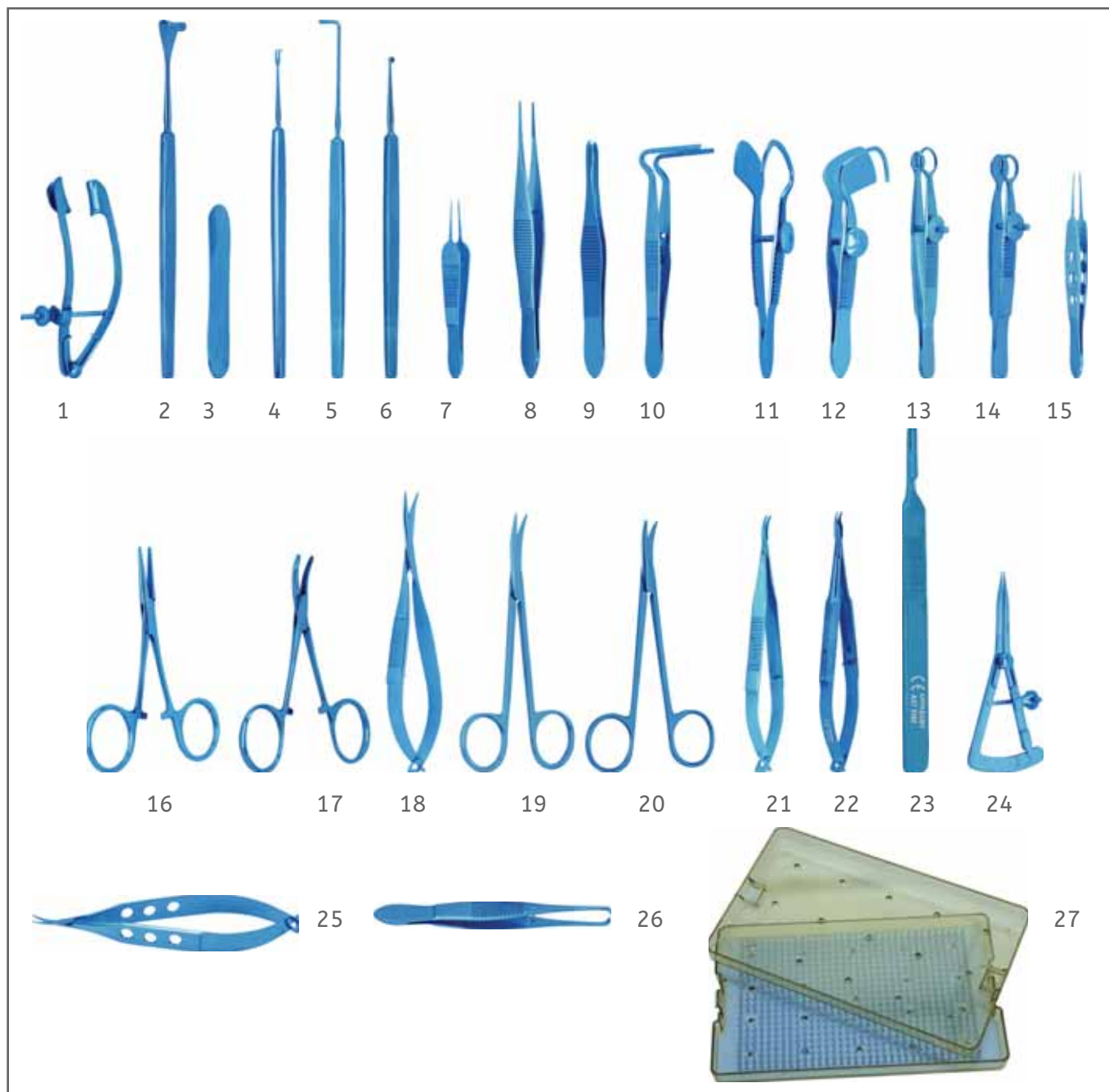

- | | |
|---|---|
| 1. AAT 1120 Lancaster eye speculum | 15. AAT 3790 McPherson tying forceps St. Long handle |
| 2. AAT 1260 Desmarres Lid retractor size 0 | 16. AAT 3920 Hartman mosquito forceps straight |
| 3. AAT 1740 Jaeger Lid plate | 17. AAT 3925 Hartman mosquito forceps curved |
| 4. AAT 1810 Fixation hook double sharp 2.0 x 1.5mm small | 18. AAT 4180 Westcott stitch scissors |
| 5. AAT 1827 Graefe muscle hook size 3 | 19. AAT 4515 Eye scissors curved 4 1/2" length |
| 6. AAT 1877 Meyerhoefer chalazion curette size 2 | 20. AAT 4535 Stevens tenotomy scissors curved |
| 7. AAT 3275 St.Martin suturing forceps, 1 x 2 teeth | 21. AAT 5095 Castroviejo needle holder standard jaws |
| 8. AAT 3300 Fixation forceps 1 x 2 teeth | 22. AAT 5145 Barraquer N.Holder short model micro jaws, w/o lock |
| 9. AAT 3485 Beer cilia forceps | 23. AAT 5460 Bard-Parker handle #3 flat |
| 10. AAT 3565 Berke ptosis forceps 20mm | 24. AAT 2075 Castroviejo caliper 20mm spread |
| 11. AAT 3600 Snellen entropium forceps left small | 25. AAT 4040 Castroviejo corneal scissors small blades |
| 12. AAT 3605 Snellen entropium forceps right small | 26. AAT 3310 Fixation forceps-2x3 teeth angular |
| 13. AAT 3615 Ayer chalazion forceps | 27. AA 8200 Plastic sterilization box with silicone mat |
| 14. AAT 3620 Lambert chalazion forceps | |

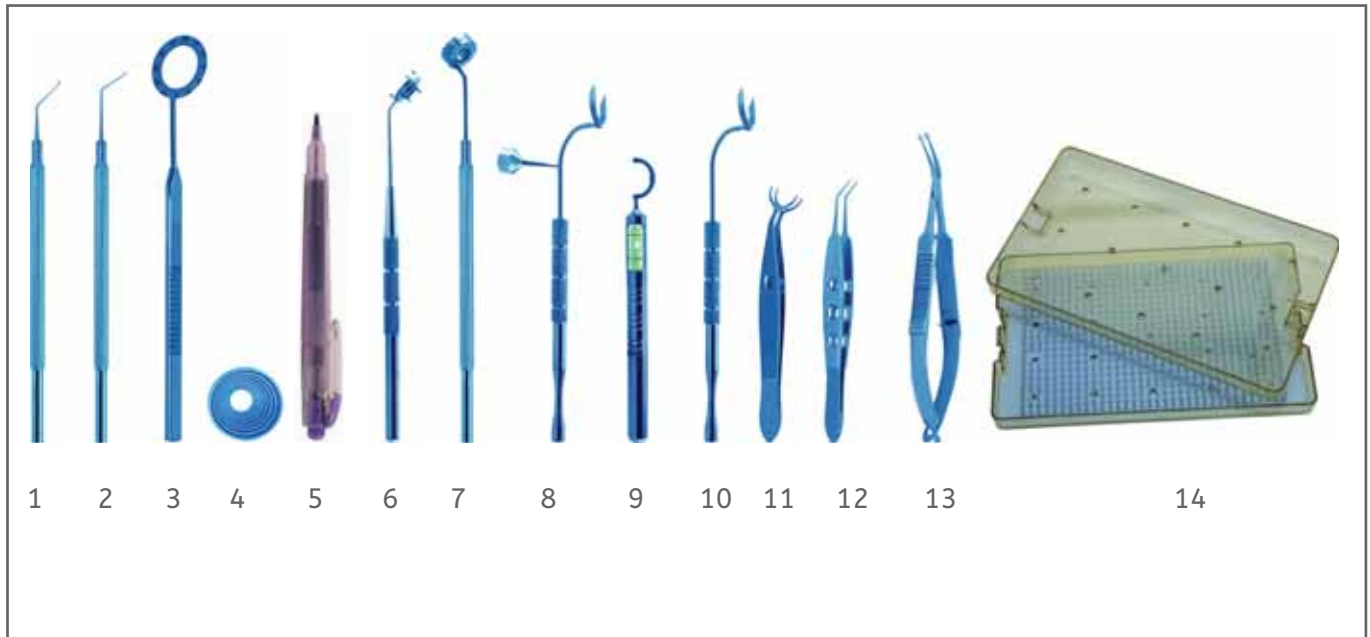

1. **AAT 1996** Rosen phaco splitter
2. **AAT 1485** Bahr-Maltzman no hole IOL manipulating hook
3. **AAT 2140** Mendez degree gauge
4. **AAT 2183** Maloney intra-operative keratometer
5. **AA 2300** Marking pen, fine tip
6. **AAT 2820** LRI marker, 6mm & 8mm chord lengths
7. **AAT 2825** LRI marker, 40-60-80 degree
8. **AAT 2800** LRI slit lamp marker
9. **AAT 2830** Pre-op Toric reference marker w/bubble level
10. **AAT 2840** LRI axis marker
11. **AAT 3415** Kremer corneal fixation forceps, curved
12. **AAT 3715** Faulkner lens holding forceps
13. **AAT 3710** Lieberman micro-ring lens forceps 1.2mm Dia
14. **AA 8200** Plastic sterilization box with silicone mat

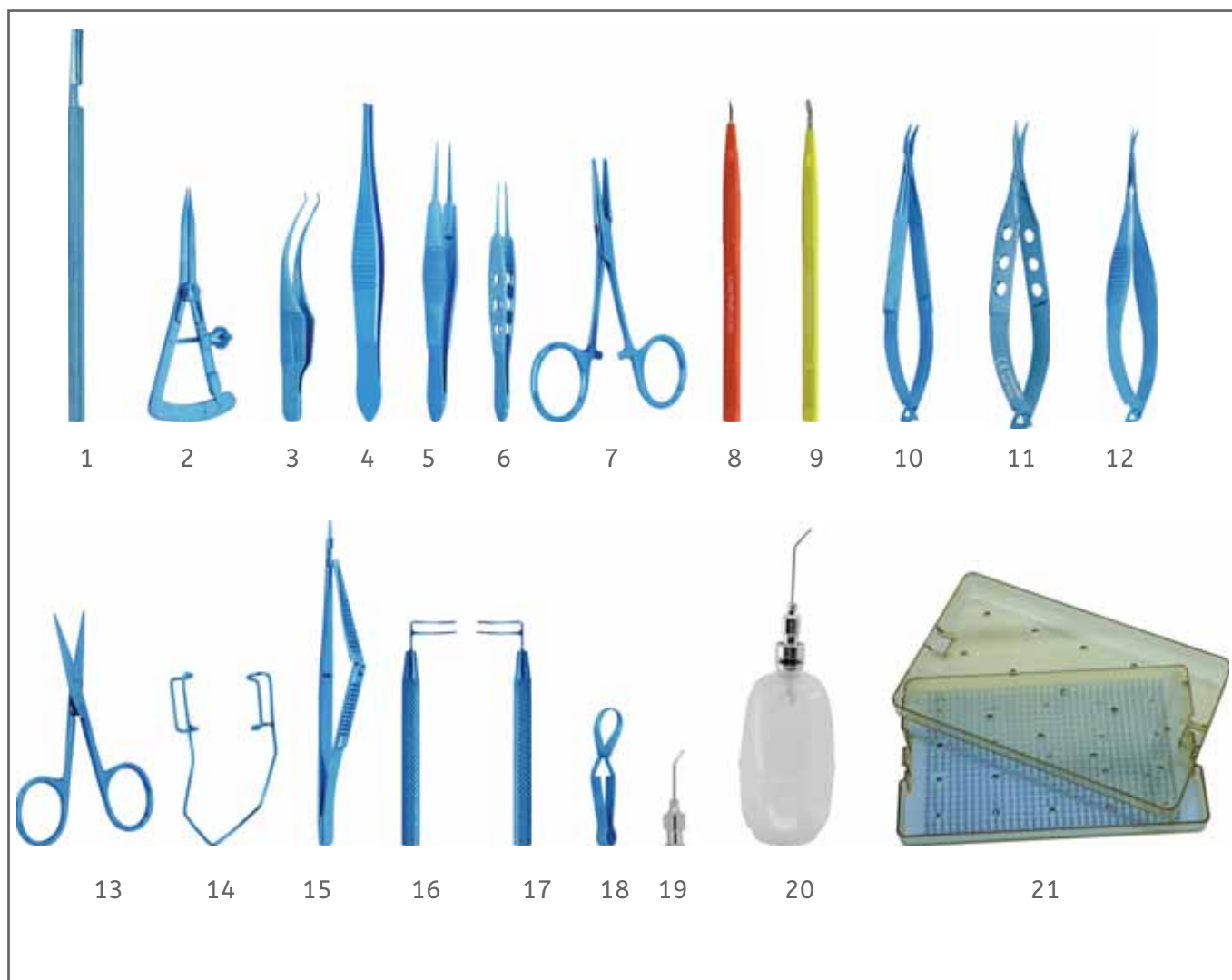

1. **AAT 5465** Bard-Parker handle #3 round handle
2. **AAT 2075** Castroviejo caliper 20mm spread
3. **AAT 3030** Colibri forceps 1 x 2 teeth 0.12mm
4. **AAT 3465** Bonaccolto utility forceps 1.2mm wide
5. **AAT 3180** Castroviejo suturing forceps 1 x 2 teeth, 0.12mm
6. **AAT 3790** McPherson tying forceps long handle
7. **AAT 3920** Hartman mosquito forceps straight
8. **AA 560012** Lance Knife (side port blade), 1.2mm
9. **AA 561021** Tunnel Knife (crescent blade), 2.1mm
10. **AAT 5165** Barraquer needle holder very delicate jaws
11. **AAT 4155** Westcott tenotomy scissors
12. **AAT 4255** Vannas capsulotomy scissors, curved
13. **AAT 4500** Iris scissors straight 3.5" length
14. **AAT 1009** Barraquer wire speculum, large
15. **AAT 6070** Kelly descemet membrane punch, 1.0mm
16. **AAT 6160** Harms trabeculotomy probe right
17. **AAT 6170** Harms trabeculotomy probe left
18. **AAT 3945** Baby Jones towel clamp
19. **AA 7125** Bracken A/C cannula curved 19 G
20. **AA 7830** Silicone bulb with adaptor
21. **AA 8200** Plastic sterilization box with silicone mat

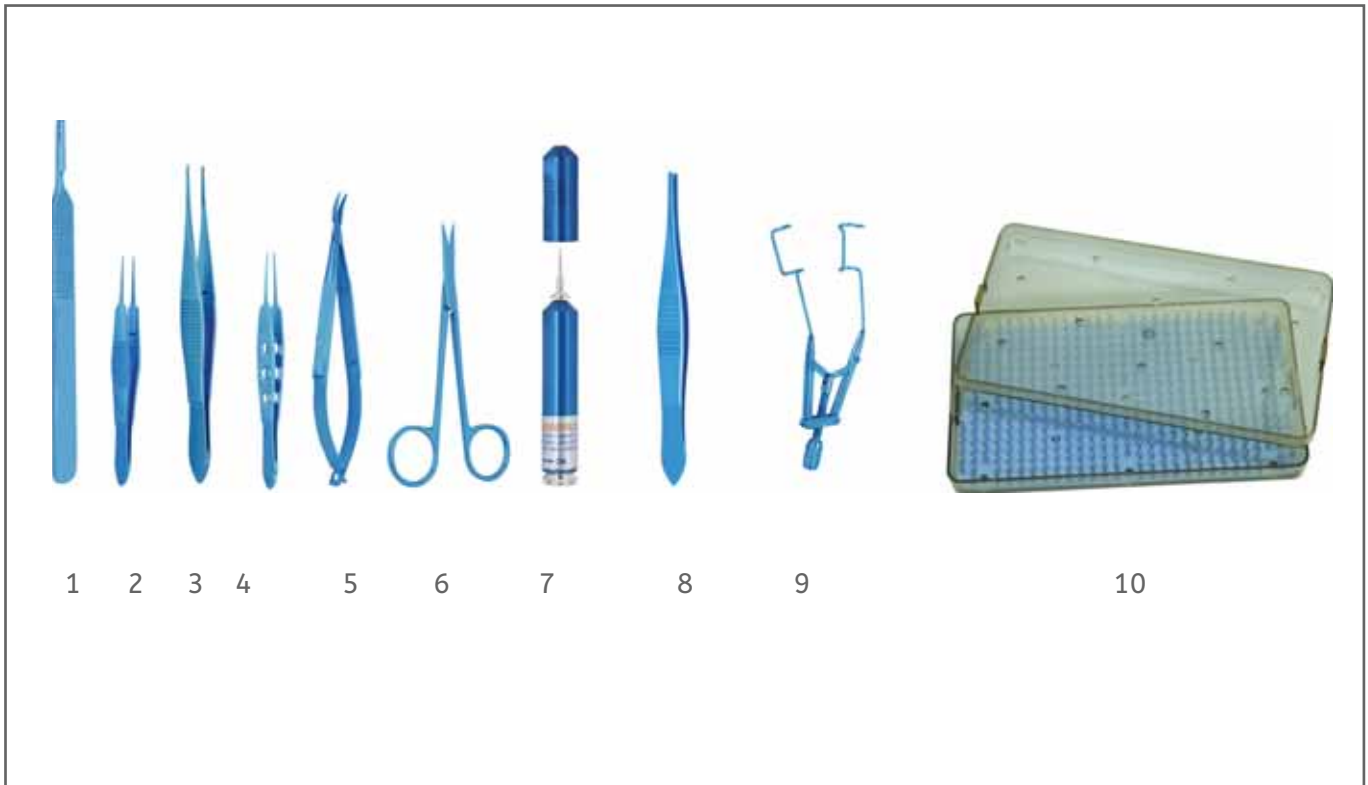

1. **AAT 5460** Bard-Parker handle #3 flat
2. **AAT 3180** Castroviejo suturing forceps 1 x 2 teeth, 0.12mm
3. **AAT 3300** Fixation forceps 1 x 2 teeth
4. **AAT 3790** Pherson tying forceps long handle
5. **AAT 5165** Barraquer needle holder very delicate jaws
6. **AAT 4510** Eye scissors straight 4 1/2" length
7. **AAT 1430** Algerbrush corneal rust ring remover battery powered
8. **AAT 3465** Bonaccolto utility forceps 1.2mm wide
9. **AAT 1184** Lieberman temporal speculum
10. **AA 8201** Plastic sterilization box with silicone mat

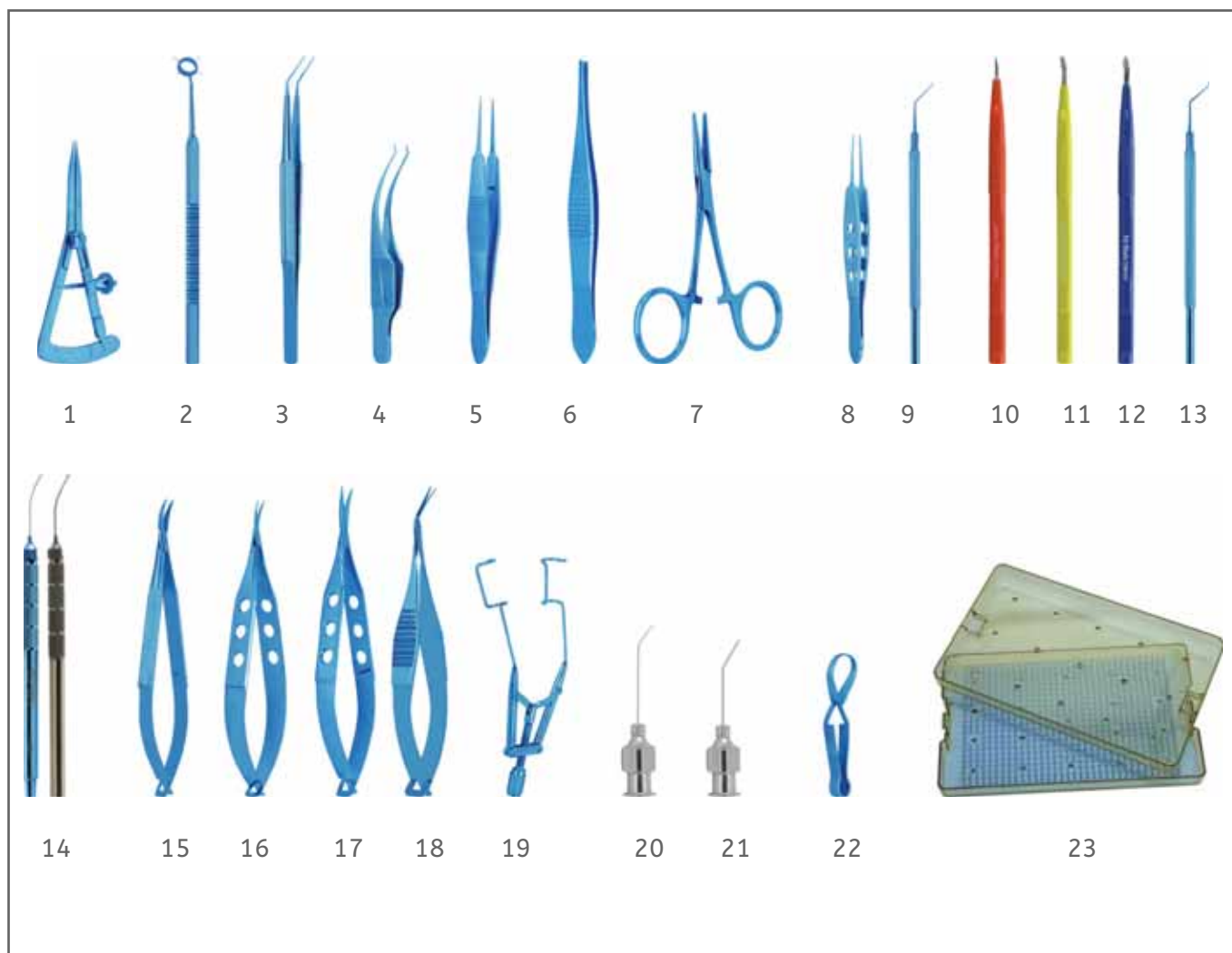

1. **AAT 2075** Castroviejo caliper 20mm spread, straight
2. **AAT 2283** Capsulorhexis marker 6mm diameter marking ring
3. **AAT 3868** Utrata capsulorhexis forceps, round handle, Extra delicate
4. **AAT 3030** Colibri forceps 1 x 2 teeth 0.12mm
5. **AAT 3180** Castroviejo suturing forceps 1 x 2 teeth, 0.12mm
6. **AAT 3465** Bonaccolto utility forceps 1.2mm wide
7. **AAT 3920** Hartman mosquito forceps straight
8. **AAT 3790** McPherson tying forceps long handle
9. **AAT 1465** Sinsky II lens manipulating hook angled
10. **AA 560012** Lance Knife (side port blade), 1.2mm
11. **AA 561021** Tunnel Knife (crescent blade), 2.1mm
12. **AA 562028** Slit Knife 2.8mm (keratome blade)
13. **AAT 1993** Agarwal phaco chopper 1mm fully cutting edge
14. **AAT 7410/11** I/A Bimanual set
15. **AAT 5165** Barraquer needle holder very delicate jaws
16. **AAT 4040** Castroviejo corneal scissors small blades
17. **AAT 4155** Westcott tenotomy scissors
18. **AAT 4295** Gills-Vannas capsulotomy scissors
19. **AAT 1184** Lieberman temporal speculum
20. **AA 7107** Rycroft air injection cannula 27 G
21. **AA 7205** Pearce hydrodissection cannula, 25 G
22. **AAT 3945** Baby Jones towel clamp
23. **AA 8200** Plastic sterilization box with silicone mat

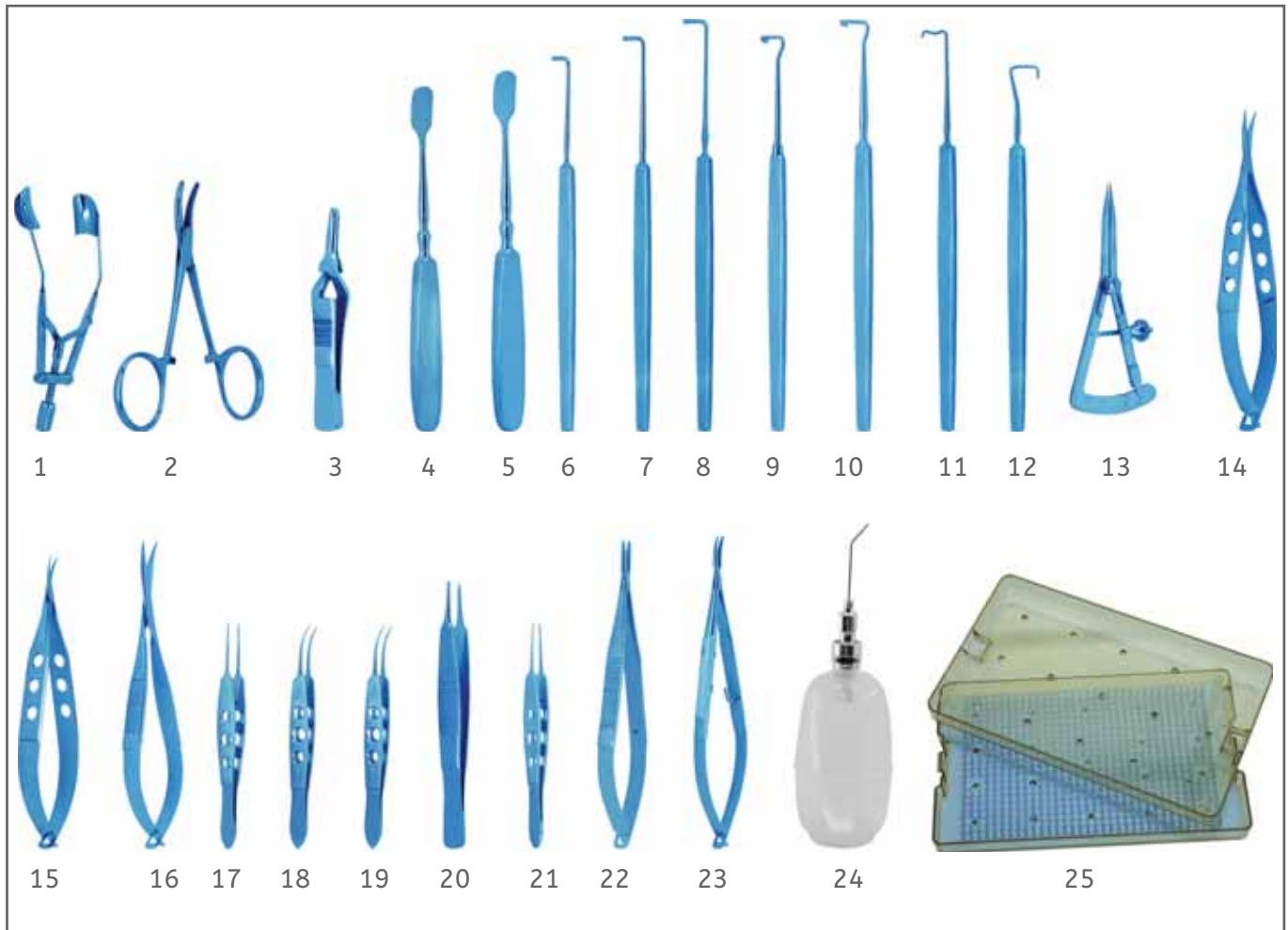

1. **AAT 1187** Lieberman - Tennant eye speculum solid, blades
2. **AAT 3925** Hartman mosquito forceps curved
3. **AAT 3950** Serrefine small straight
4. **AAT 1885** Mule evisceration scoop small
5. **AAT 1886** Mule evisceration scoop large
6. **AAT 1825** Graefe muscle hook size 1
7. **AAT 1826** Graefe muscle hook size 2
8. **AAT 1827** Graefe muscle hook size 3
9. **AAT 1835** Jameson muscle hook small
10. **AAT 1837** Jameson muscle hook large
11. **AAT 1850** Chavasse muscle hook
12. **AAT 1855** Culler rectus muscle hook
13. **AAT 2075** Castroviejo caliper 20mm spread straight
14. **AAT 4155** Westcott tenotomy scissors
15. **AAT 4040** Castroviejo corneal scissors small blades
16. **AAT 4180** Westcott stitch scissors
17. **AAT 3170** Bonn forceps, long model, 0.12mm, 1 x 2 teeth
18. **AAT 3350** Moody fixation forceps 1 x 2 teeth, 0.5mm left
19. **AAT 3351** Moody fixation forceps 1 x 2 teeth, 0.5mm right
20. **AAT 3330** Lester fixation forceps straight 1 x 2 teeth
21. **AAT 3790** McPherson tying forceps long handle
22. **AAT 5060** Castroviejo needle holder straight, with lock
23. **AAT 5160** Barraquer needle holder curved with lock
24. **AA 7830** Silicone bulb with adaptor
25. **AA 8200** Plastic sterilization box with silicone mat

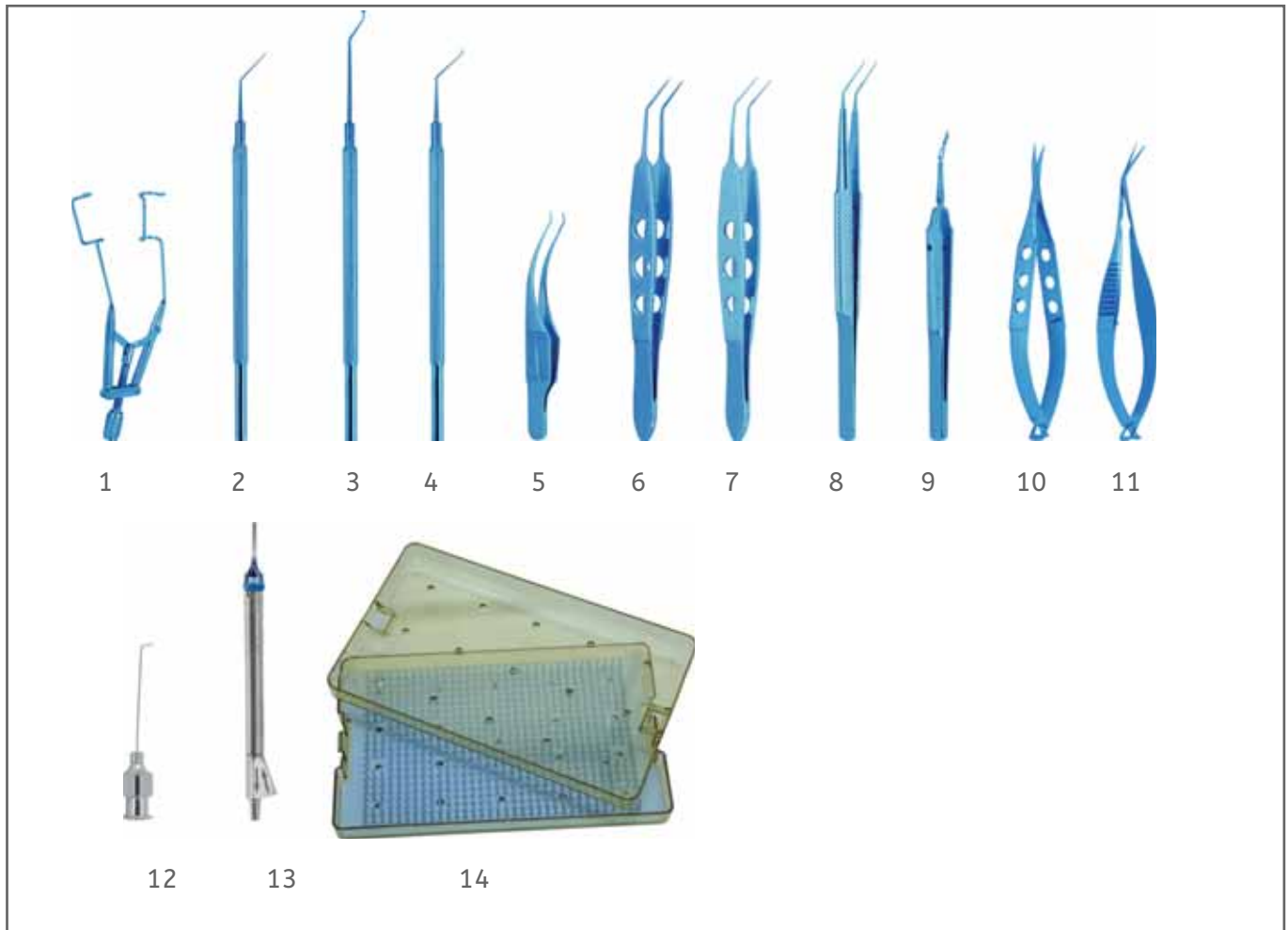

1. **AAT 1184** Lieberman temporal speculum
2. **AAT 1465** Sinsky II lens manipulating hook angled
3. **AAT 1597A** Akahoshi nucleus ring sustainer
4. **AAT 1989B** Mohan Rajan micro combo chopper pointed tips 1.50mm
5. **AAT 3030** Colibri forceps 1 x 2 teeth 0.12mm
6. **AAT 3805** McPherson IOL forceps, 11mm angled
7. **AAT 3855** Utrata capsulorhexis forceps
8. **AAT 3869** Utrata capsulorhexis forceps straight round handle
9. **AAT 3913B** Akahoshi combo pre chopper
10. **AAT 4155** Westcott tenotomy scissors
11. **AAT 4275** Vannas capsulotomy scissors angle forward 11mm
12. **AA 7295** Akahoshi hydrodissection cannula 27 G
13. **AAT 7393/94** I/A Probe
14. **AA 8200** Plastic sterilization box with silicone mat

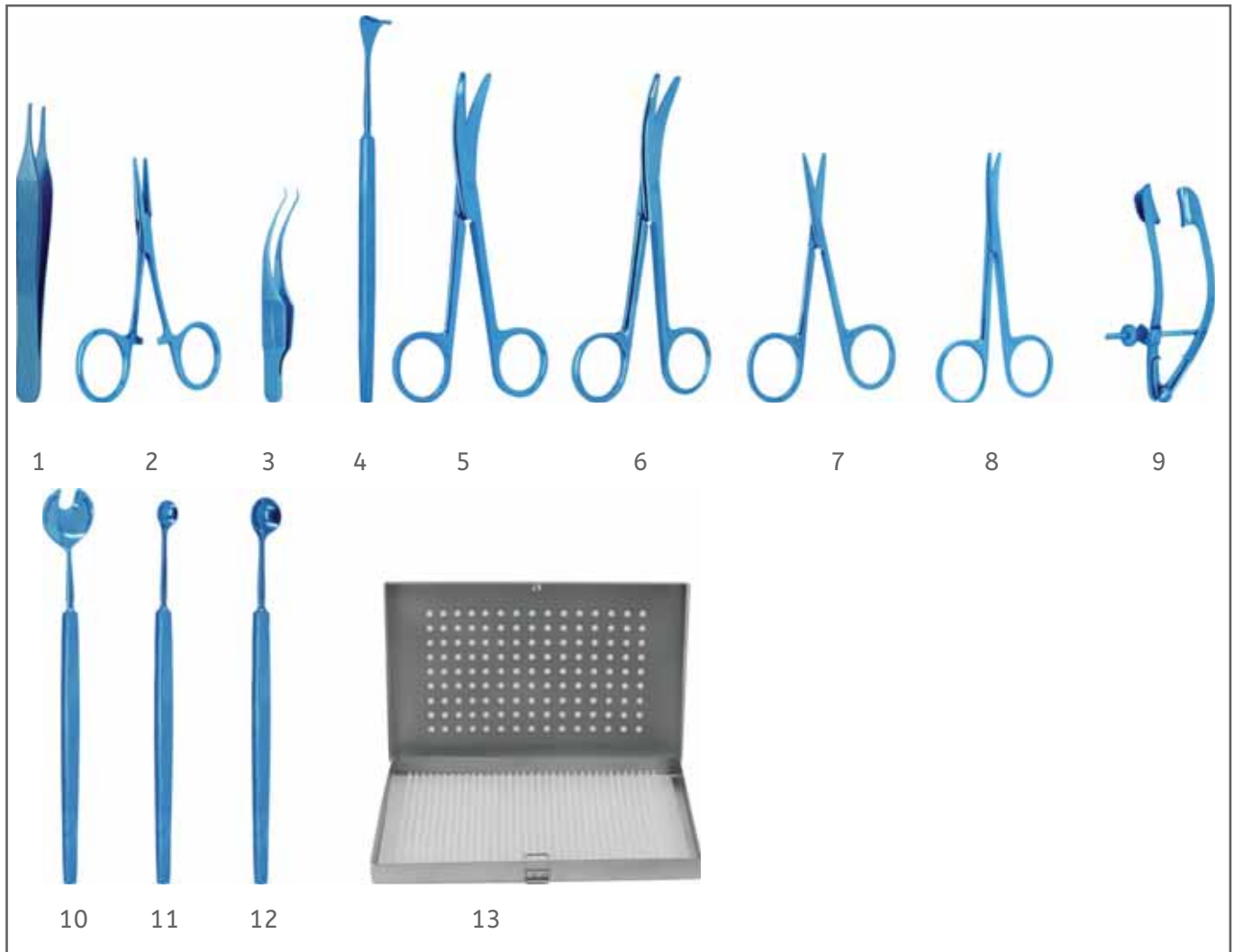

1. **AAT 3301** Adson fixation forceps
2. **AAT 3920** Hartman mosquito forceps straight
3. **AAT 3030** Colibri forceps 1 x 2 teeth 0.12mm
4. **AAT 1261** Desmarres Lid retractor size 1-12mm width
5. **AAT 4580** Enucleation scissors ring handle medium curve
6. **AAT 4585** Enucleation scissors ring handle strong curve
7. **AAT 4550** Knapp strabismus scissors blunt tips ring handle straight
8. **AAT 4555** Knapp strabismus scissors blunt tips ring handle curved
9. **AAT 1120** Lancaster eye speculum
10. **AAT 1890** Wells enucleation spoon small
11. **AAT 1880** Bunge evisceration spoon small
12. **AAT 1881** Bunge evisceration spoon large
13. **AA 8005** Sterilization box with silicone mat

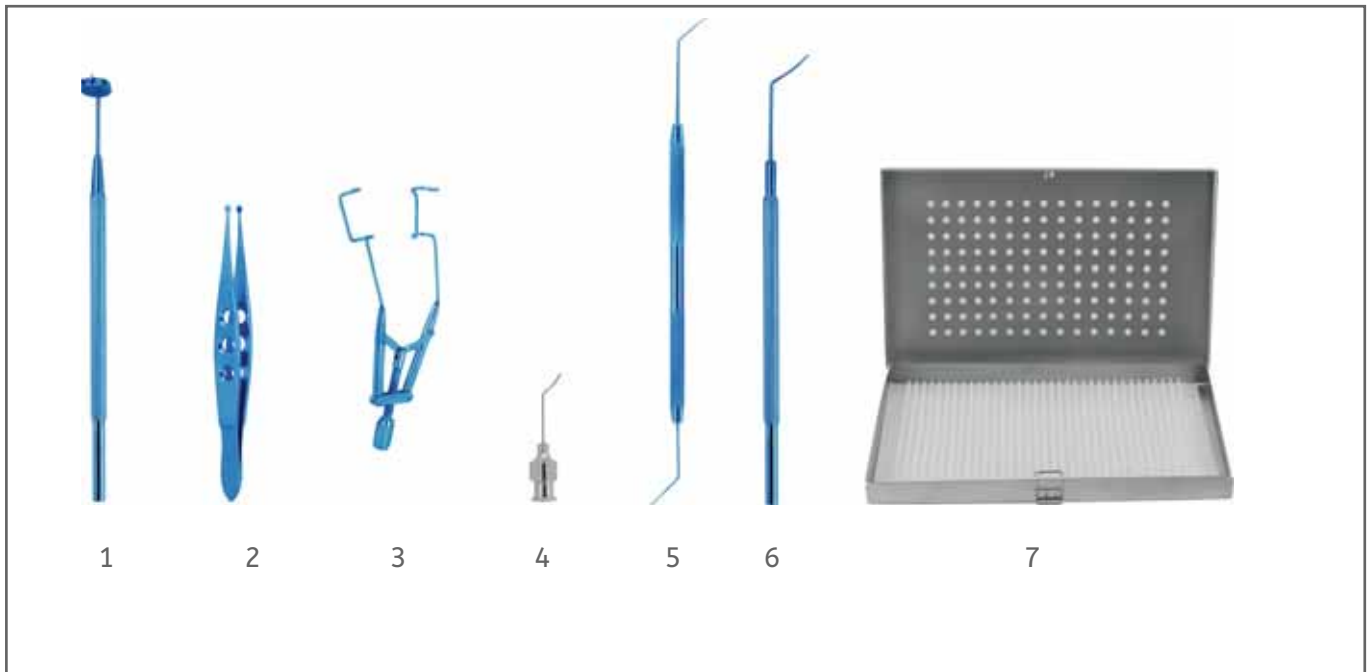

1. **AAT 2182** Appa LASIK marker
2. **AAT 3876** Buratto LASIK flap forceps
3. **AAT 1184** Lieberman temporal speculum
4. **AA 7885** Buratto LASIK cannula 23 G
5. **AAT 1639** LASIK flap lifter combines a 45°angled
6. **AAT 1666** Slade femtosecond spatula
7. **AA 8005** Sterilization box with silicone mat

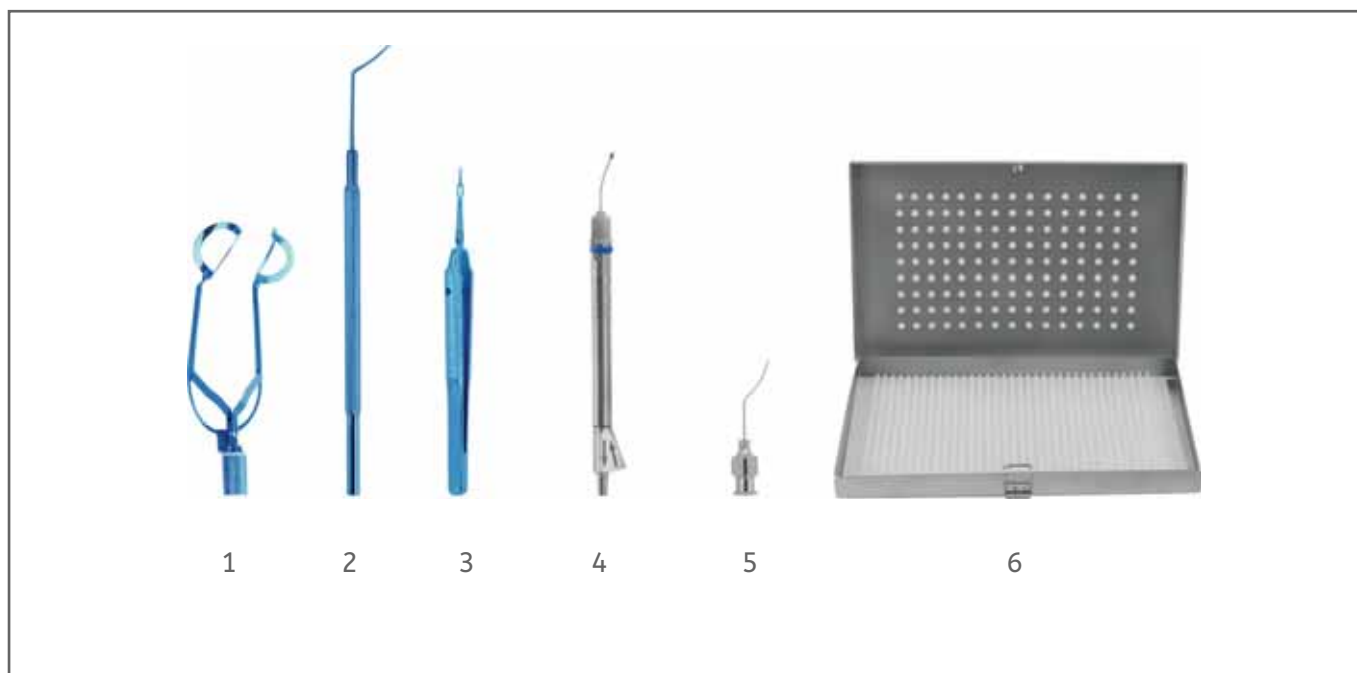

1. **AAT Busin** Jerome Bovert speculum reversible
2. **AAT 1666** Slade femtosecond spatula
3. **AAT 3907** Akahoshi nucleus splitter forceps
4. **AAT 7393/98** I/A Probe handle with s-curve polished
5. **AA 7222** Slade femtosecond cannula
6. **AA 8005** Sterilization box with silicone mat

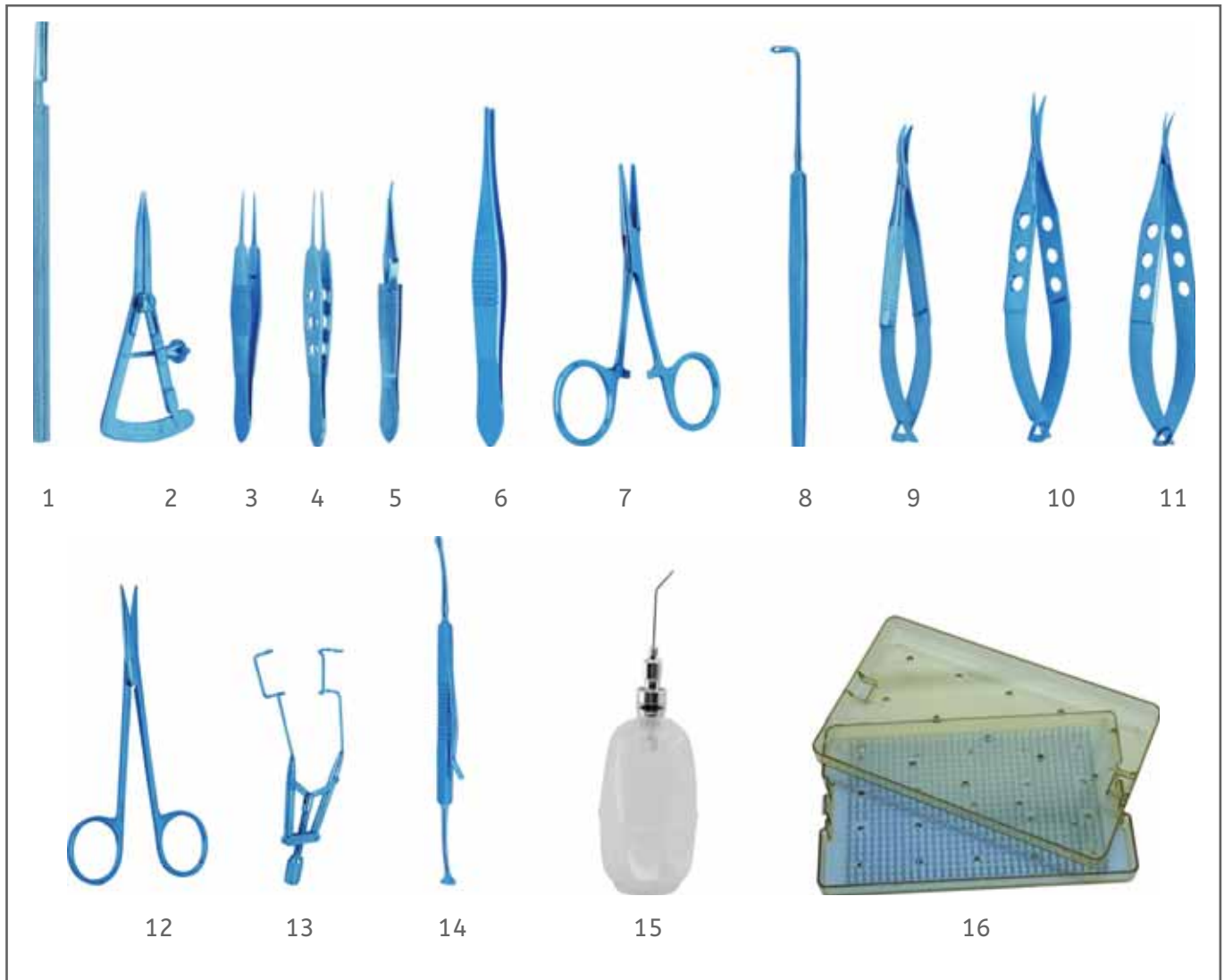

1. **AAT 5465** Bard-Parker handle #3 round handle
2. **AAT 2075** Castroviejo caliper 20mm spread straight
3. **AAT 3180** Castroviejo suturing forceps 1 x 2 teeth, 0.12mm
4. **AAT 3790** McPherson tying forceps long handle
5. **AAT 7930** Watzke sleeve spreading forceps
6. **AAT 3465** Bonaccolto utility forceps 1.2mm wide
7. **AAT 3920** Hartman mosquito forceps straight
8. **AAT 1830** Gass retinal detachment hook
9. **AAT 5135** Barraquer needle holders short model curved without lock
10. **AAT 4155** Westcott tenotomy scissors
11. **AAT 4040** Castroviejo corneal scissors small blades
12. **AAT 4530** Stevens tenotomy scissors blunt tips, ring handle straight
13. **AAT 1184** Lieberman temporal speculum
14. **AAT 1310** Schocket scleral depressor double-end with pocket clip
15. **AA 7830** Silicone bulb with adaptor
16. **AA 8200** Plastic sterilization box with silicone mat

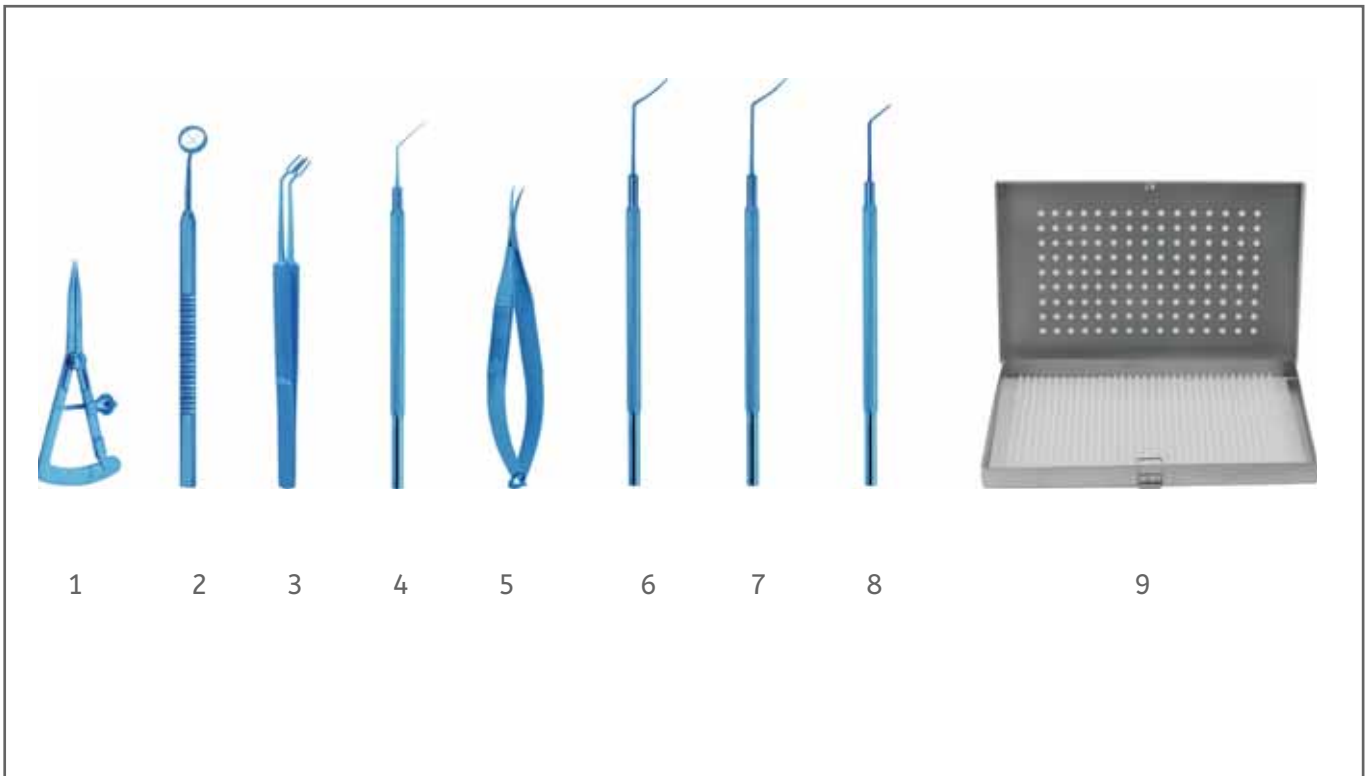

1. **AAT 2075** Castroviejo caliper 20mm spread straight
2. **AAT 2203** Hoffer optic zone marker 8.00mm dia.
3. **AAT 3411** Nevyas Wallace fixation forceps
4. **AAT 2515** DSEK reverse sinskey hook
5. **AAT 4110** Micro Iris scissors curved, pointed tipslarge blades
6. **AAT 1398** Corneal dissector for intrastromal dissection angled, straight-blade
7. **AAT 1399** Corneal dissector for intrastromal dissection angled, curved-blade
8. **AAT 2565** Bonfadini DALK spatula 1mm wide, 8mm long
9. **AA 8005** Sterilization box with silicone mat

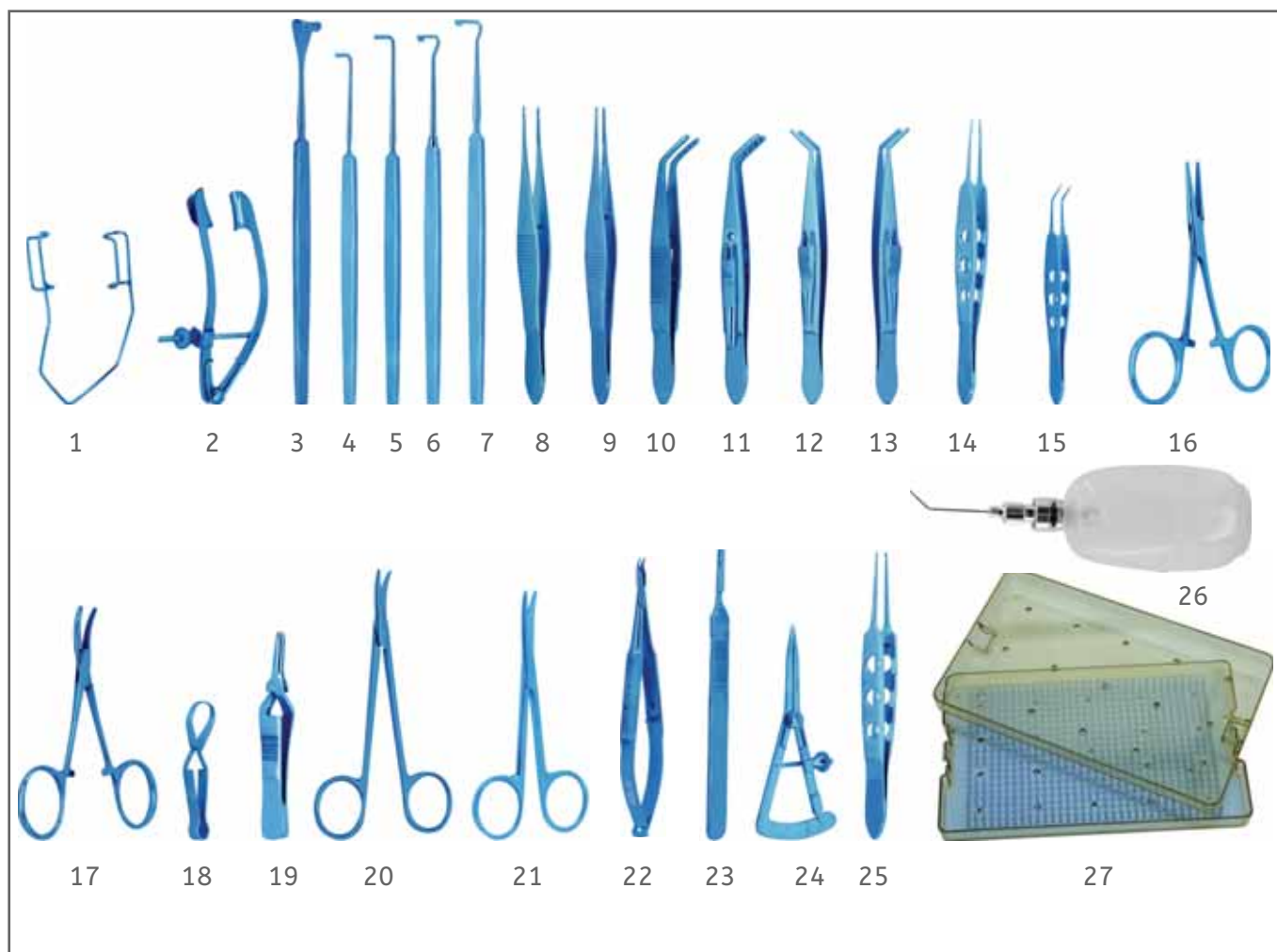

1. **AAT 1009** Barraquer wire speculum, large
2. **AAT 1120** Lancaster eye speculum
3. **AAT 1260** Desmarres Lid retractor size 0
4. **AAT 1825** Graefe muscle hook size 1
5. **AAT 1826** Graefe muscle hook size 2
6. **AAT 1835** Jameson muscle hook small
7. **AAT 1837** Jameson muscle hook large
8. **AAT 3300** Fixation forceps 1 x 2 teeth
9. **AAT 3460** Wills hospital utility forceps
10. **AAT 3535** Jameson muscle forceps left child 4 teeth
11. **AAT 3540** Jameson muscle forceps right child 4 teeth
12. **AAT 3555** Worth advancement forceps left
13. **AAT 3560** Worth advancement forceps right
14. **AAT 3790** McPherson tying forceps st. Long handle
15. **AAT 3800** Kelman-McPherson forceps 7.5mm angle long handle
16. **AAT 3920** Hartman mosquito forceps straight
17. **AAT 3925** Hartman mosquito forceps curved
18. **AAT 3945** Baby Jones towel clamp
19. **AAT 3950** Serrefine small straight
20. **AAT 4535** Stevens tenotomy scissors curved
21. **AAT 4555** Knapp strabismus scissors curved
22. **AAT 5145** Barraquer N.Holder short model micro jaws,w/o lock
23. **AAT 5460** Bard-Parker handle #3 flat
24. **AAT 2075** Castroviejo caliper 20mm spread straight
25. **AAT 3255** Bishop-Harmon tissue forceps delicate 0.8mm
26. **AA 7830** Silicone bulb with adaptor
27. **AA 8200** Plastic sterilization box with silicone mat

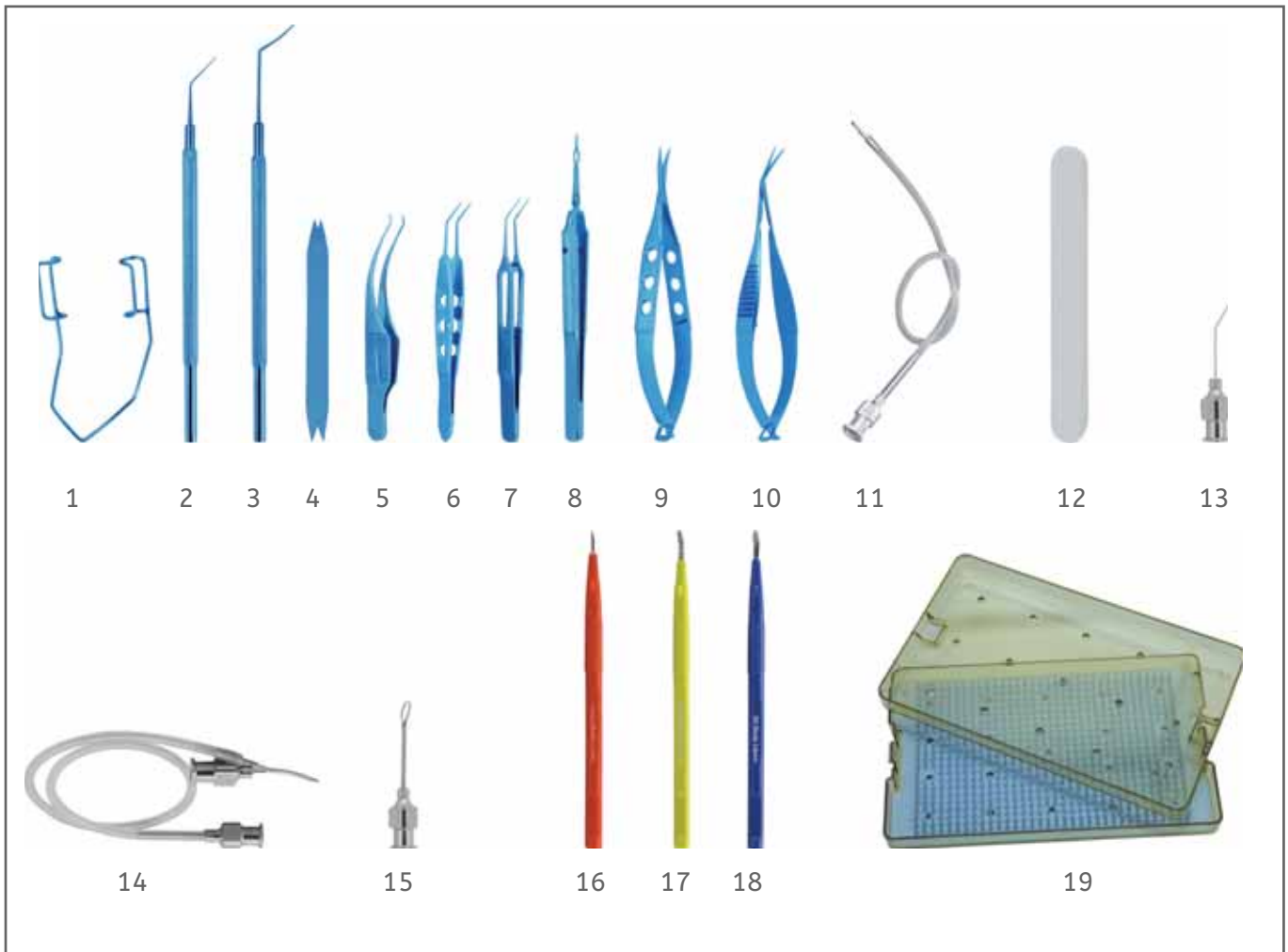

1. **AAT 1009** Barraquer wire speculum, large
2. **AAT 1465** Sinsky II lens manipulating hook angled
3. **AAT 1655** Barraquer Iris spatula, 0.25mm, angled
4. **AAT 2087** Appasamy fixed caliper double end size 3.0 & 3.50mm
5. **AAT 3030** Colibri forceps 1 x 2 teeth 0.12mm
6. **AAT 3805** McPherson IOL forceps, 11mm angled
7. **AAT 3855** Utrata capsulorhexis forceps, long straight shanks
8. **AAT 3907** Akahoshi nucleus splitter forceps
9. **AAT 4155** Westcott tenotomy scissors
10. **AAT 4275** Vannas capsulotomy scissors angle forward 11mm
11. **AA 7150** Lewicky Anterior Chamber maintainer
12. **AA 7202** IOL glide, silicone
13. **AA 7205** Pearce hydrodissection cannula, 25 G
14. **AA 7447** Ruit irrigating/aspirating cannula, 23 G
15. **AA 7705** Knolle-Pearce irrigating vectis, 4mm wide, 7mm long loop
16. **AA 560012** Lance Knife (side port blade), 1.2mm
17. **AA 561021** Tunnel Knife (crescent blade), 2.1mm
18. **AA 562028** Slit Knife 2.8mm (keratome blade)
19. **AA 8200** Plastic sterilization box with silicone mat

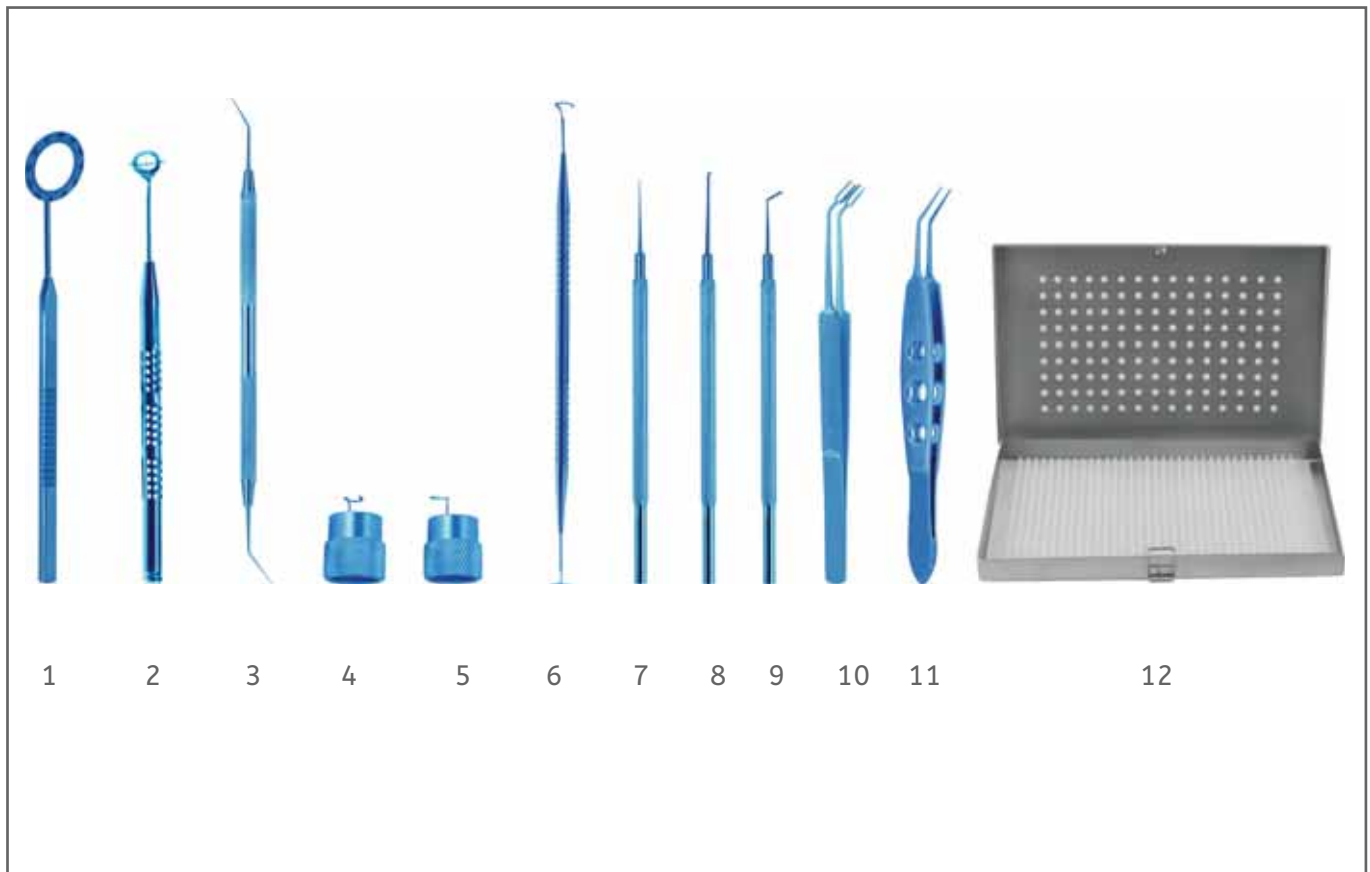

1. **AAT 2140** Mendez degree gauge
2. **AAT 2146** Tunnel zone marker
3. **AAT 2221** Optical zone marker double ended
4. **AAT 2432** ICSR tunnel marker, left
5. **AAT 2433** ICSR tunnel marker, right
6. **AAT 2434** ICSR tunnel maker double end small
7. **AAT 2516** Elevator for ICSR implantation
8. **AAT 2517** Suarez spreader
9. **AAT 2518** Bicalto guide
10. **AAT 3411** Nevyas Wallace fixation forceps
11. **AAT 3671** ICSR implantation forceps 1x1 teeth 0.2mm
12. **AA 8005** Sterilization box with silicone mat

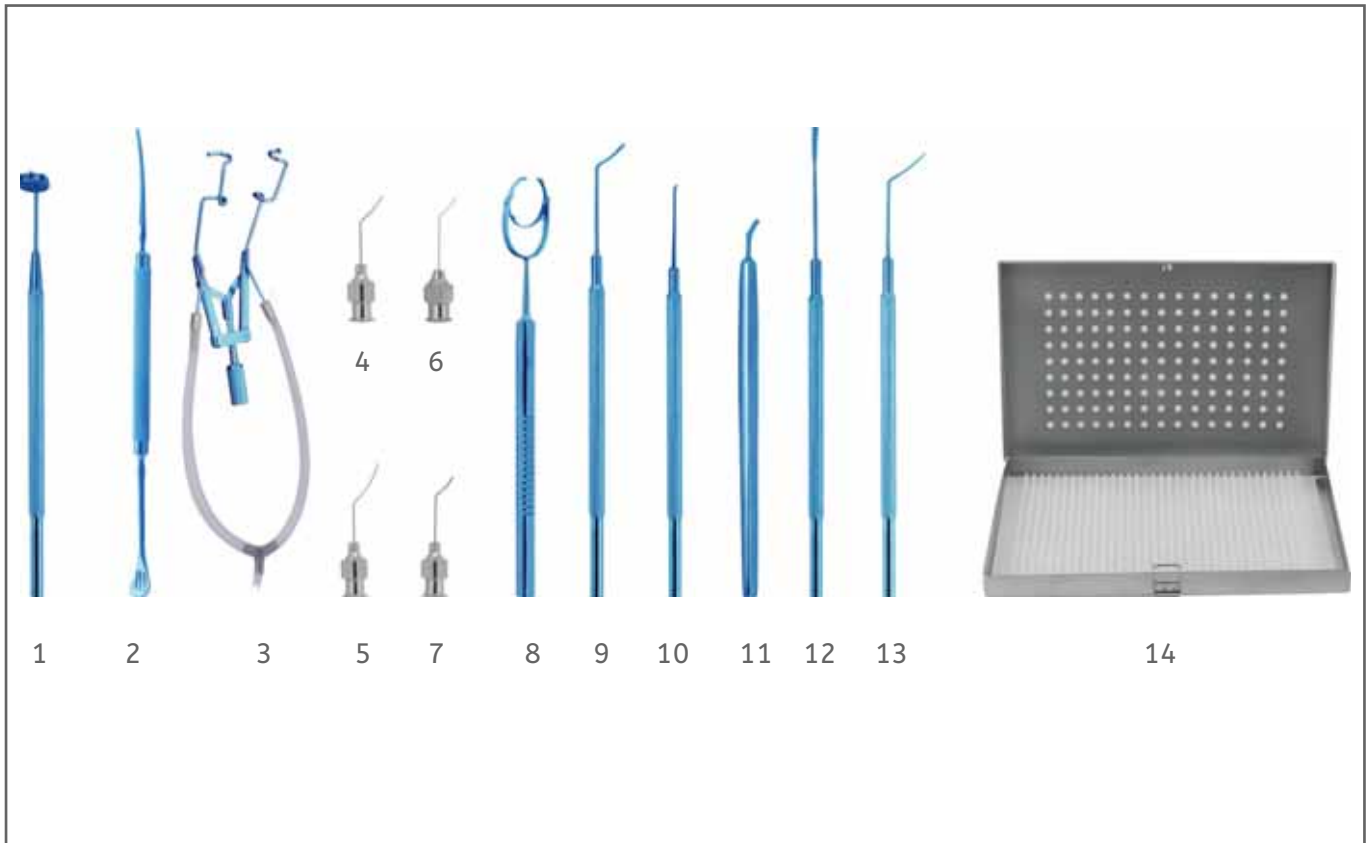

1. **AAT 2182** Appa LASIK marker AA 3876 buratto LASIK flap forceps
2. **AAT 1710** Paton spatula & spoon
3. **AAT 1086** Lieberman irrigating speculum, temporal
4. **AA 7880** Banaji LASIK cannula (6 ports)
5. **AA 7222** Slade femtosecond cannula
6. **AA 7875** Gimbel LASIK fountain cannula 45° angled 5mm
7. **AA 7885** Buratto LASIK cannula 23 G
8. **AAT 1817** Shepard fixation ring
9. **AAT 1683** LASIK spatula
10. **AAT 2517** Suarez spreader
11. **AAT 2400** LASEK hockey knife
12. **AAT 2415** LASEK epithelial flap repositioning spatula
13. **AAT 1666** Slade femtosecond spatula
14. **AA 8005** Sterilization box with silicone mat

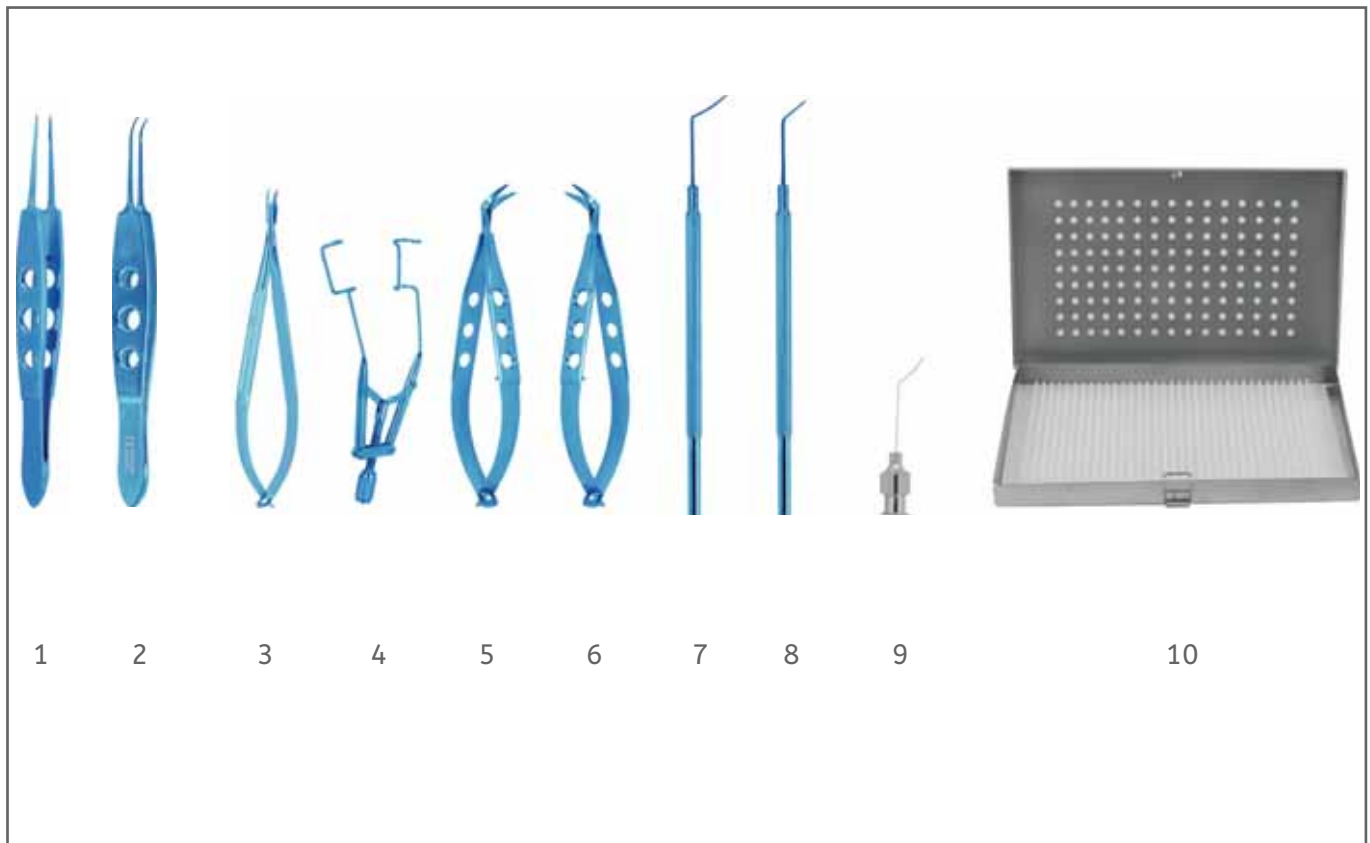

1. **AAT 3750** Jaffe tying forceps smooth jaws with 5mm long platform straight
2. **AAT 3755** Jaffe tying forceps smooth jaws with 5mm long platform curved
3. **AAT 5175** Barraquer needle holder micro without lock
4. **AAT 1184** Lieberman temporal speculum
5. **AAT 4020** Katzin corneal transplant scissors, left
6. **AAT 4025** Katzin corneal transplant scissors, right
7. **AAT 2560** Rosenwasser DALK trisector
8. **AAT 2565** Bonfadini DALK spatula
9. **AA 7100** DALK air injection cannula
10. **AA 8005** Sterilization box with silicone mat

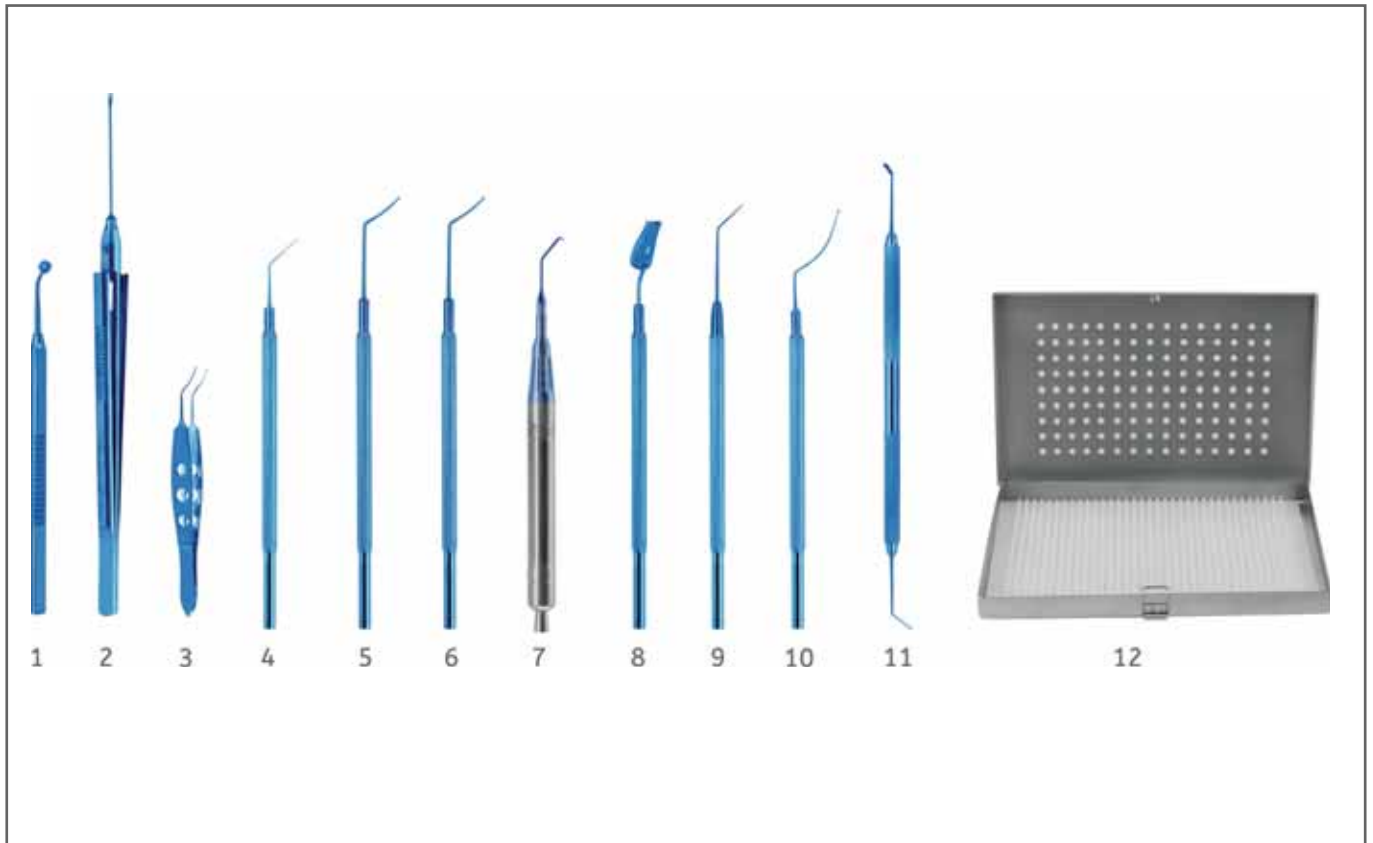

1. **AAT 2230** Hoffer optic zone marker
2. **AAT 3990** Iridectomy forceps
3. **AAT 3731** Donor lamellar inserting forceps
4. **AAT 2515** Reverse Sinsky hook
5. **AAT 1398** Corneal dissector, straight blade
6. **AAT 1399** Corneal dissector, vaulted blade
7. **AAT 8325** Irrigating endothelial stripper 20 G tip set
8. **AAT 1696** Busin endothelial glide
9. **AAT 1625A** Appasamy plain rod 11mm angled
10. **AAT 2505** DSAEK stromal scrubber
11. **AAT 2530** Rosenwasser lamellar donor inserting shovel
12. **AA 8005** Sterilization box with silicone mat

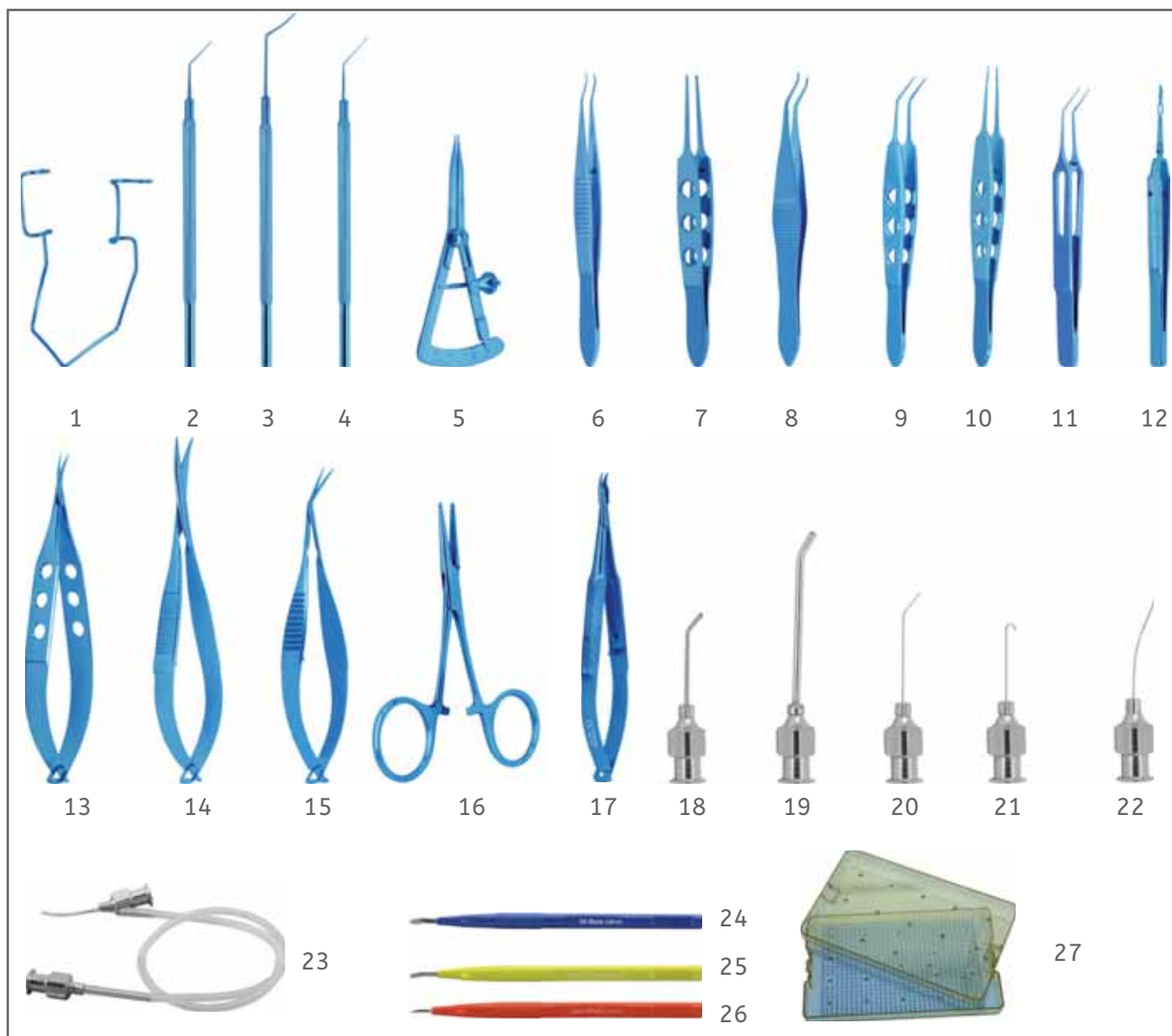

- | | |
|--|---|
| 1. AAT 1025 Kratz -Barraquer wire speculum, big | 14. AAT 4180 Westcott stitch scissors |
| 2. AAT 1465 Sinsky II lens manipulating hook angled | 15. AAT 4275 Vannas capsulotomy scissors angle forward 11mm |
| 3. AAT 1655 Barraquer IRIS spatula, 0.25mm, angled | 16. AAT 3920 Hartman mosquito forceps straight |
| 4. AAT 1993 Agarwal phaco chopper 1mm fully cutting edge | 17. AAT 5145 Barraquer N.Holder short model micro jaws, without lock |
| 5. AAT 2075 Castroviejo caliper 20mm spread | 18. AA 7105 Rycroft air injection cannula, 23 G |
| 6. AAT 3145 Lim's corneoscleral forceps 0.12mm, 1 x 2 teeth | 19. AA 7145 Anterior chamber washout cannula 16 G |
| 7. AAT 3255 Bishop-Harmon tissue forceps delicate 0.8mm | 20. AA 7205 Pearce hydrodissection cannula , 35deg. Angled 25 G |
| 8. AAT 3340 Dastoor superior rectus forceps, 1 x 2 teeth | 21. AA 7215 Gimbel 'U' shaped hydrodissector, 25 G |
| 9. AAT 3805 McPherson IOL forceps, 11mm angled | 22. AA 7230 Kellan hydrodelineation cannula curved Bevel tip 25 G |
| 10. AAT 3790 McPherson tying forceps st. Long handle | 23. AA 7420 Simcoe I/A cannula 23 G direct |
| 11. AAT 3855 Utrata capsulorhexis forceps flat handle | 24. AA 560012 Lance Knife (side port blade), 1.2mm |
| 12. AAT 3913 Akahoshi super combo prechopper | 25. AA 561021 Tunnel Knife (crescent blade), 2.1mm |
| 13. AAT 4040 Castroviejo corneal scissors small blades | 26. AA 562028 Slit Knife 2.8mm (keratome blade) |
| | 27. AA 8200 Plastic sterilization box with silicone mat |

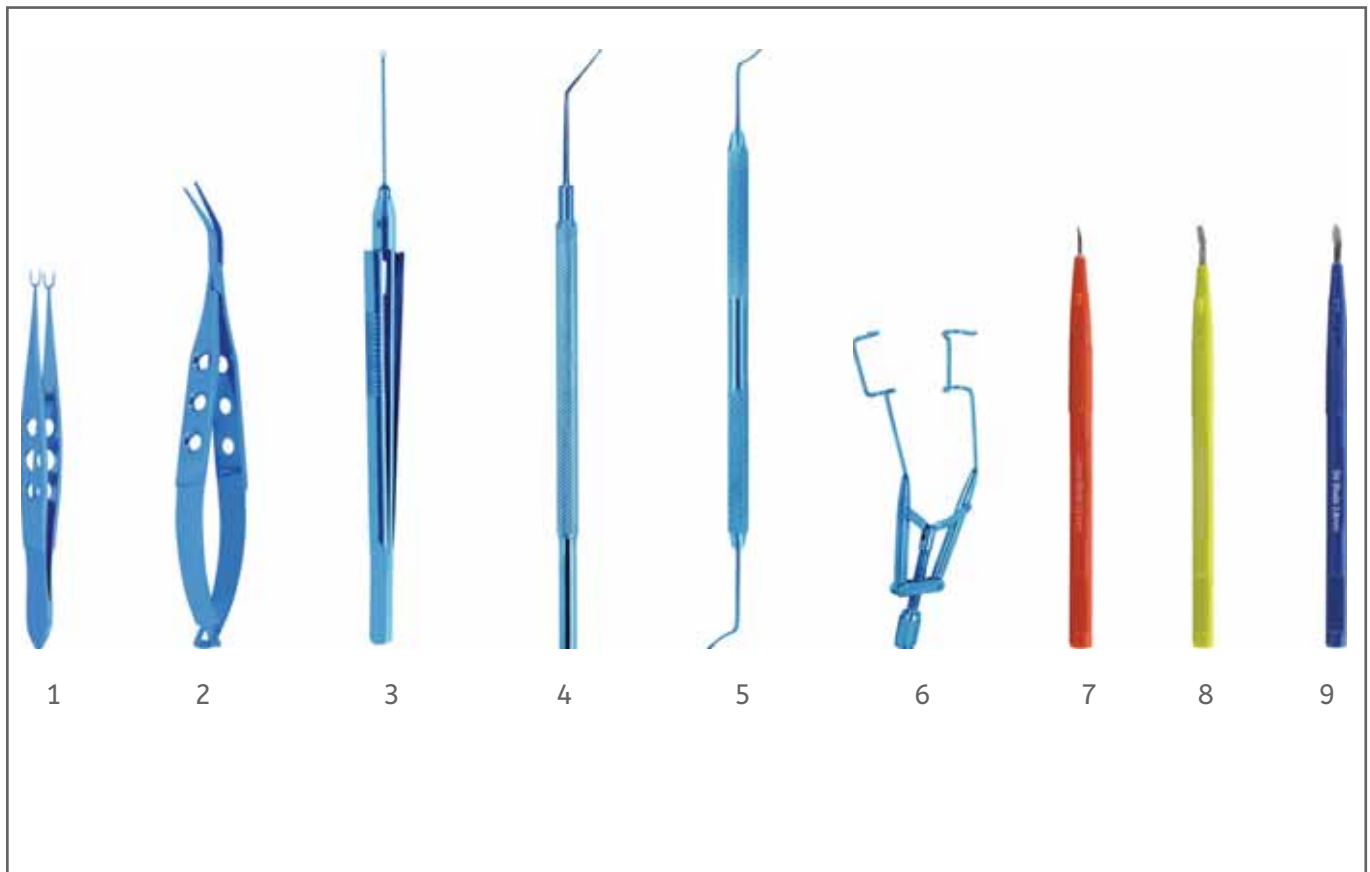

1. **AAT 3400** Bores incision spreading forceps
2. **AAT 3721** DSEK inserting forceps
3. **AAT 3987** Lens cartridge loading forceps, straight 20 G
4. **AAT 1482** Pallikaris lens manipulator
5. **AAT 1481** Zaldivar lens manipulator double ended
6. **AAT 1184** Lieberman temporal speculum
7. **AA 560012** Lance Knife (side port blade), 1.2mm
8. **AA 561021** Tunnel Knife (crescent blade), 2.1mm
9. **AA 562028** Slit Knife 2.8mm (keratome blade)

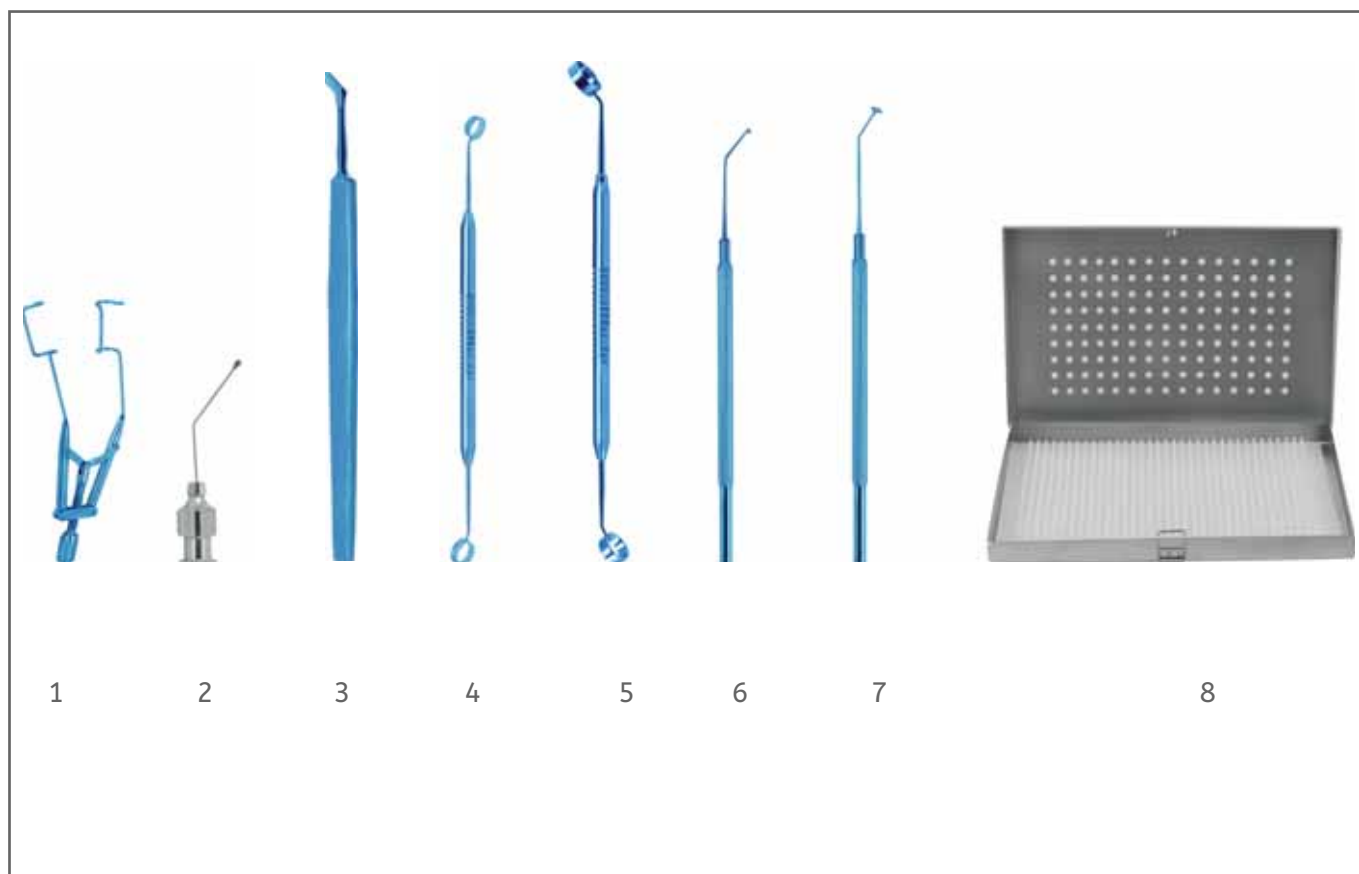

1. **AAT 1184** Lieberman temporal speculum
2. **AA 7345** Troutman alpha-chymotrypsin cannula
3. **AAT 1390** Paton corneal dissector
4. **AAT 2430** LASEK trephine 8mm & 8.5mm
5. **AAT 2425** LASEK alcohol well 8mm & 8.5mm
6. **AAT 2405** LASEK epithelial detaching spatula
7. **AAT 2410** LASEK epithelial micro hoe
8. **AA 8005** Sterilization box with silicone mat

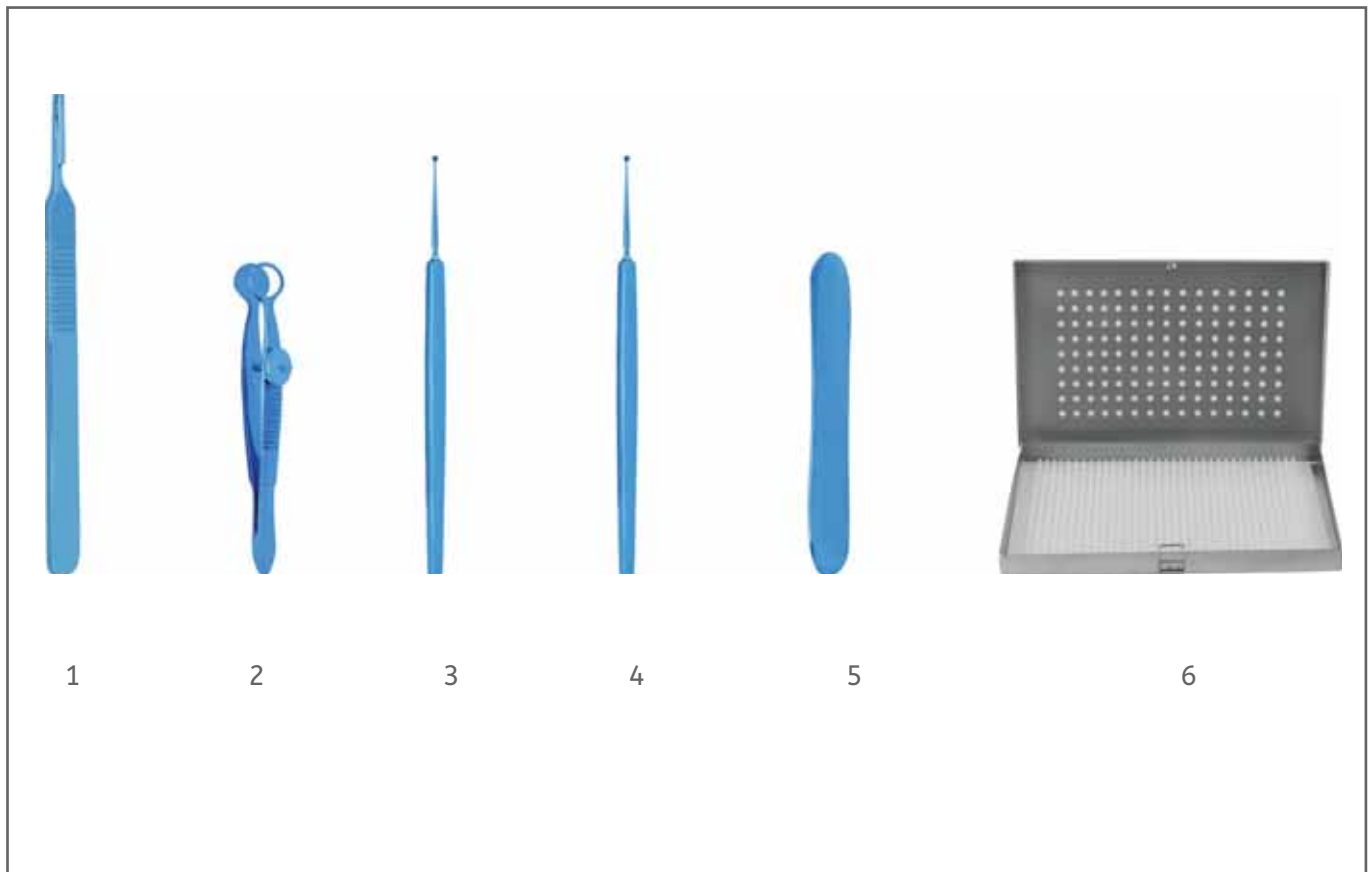

1. **AAT 5460** Bard-Parker handle #3 flat
2. **AAT 3625** Desmarres chalazion forceps 13mm/20mm Dia
3. **AAT 1875** Meyerhoefer chalazion curette size 0, 1.50mm Dia
4. **AAT 1877** Meyerhoefer chalazion curette size 2, 2.25mm Dia
5. **AAT 1740** Jaeger Lid plate
6. **AA 8005** Sterilization box with silicone mat

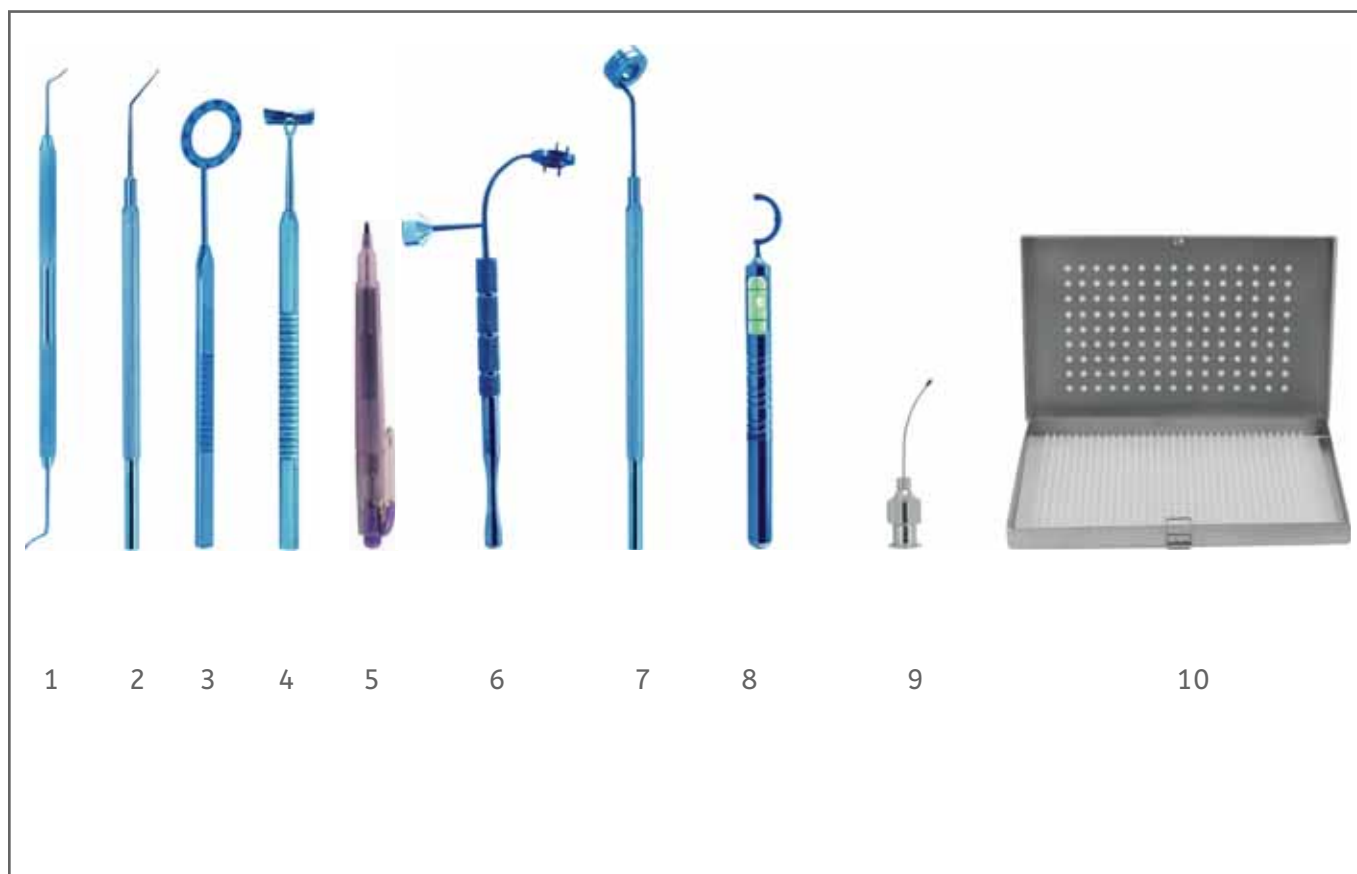

1. **AAT 1481** Zaldivar lens manipulator double ended
2. **AAT 1482** Pallikaris lens manipulator
3. **AAT 2140** Mendez degree gauge
4. **AAT 2145** Bores axis marker
5. **AA 2300** Marking pen, fine tip
6. **AAT 2815** Toric combo marker
7. **AAT 2825** LRI marker 40-60-80 degree
8. **AAT 2830** Pre-op Toric reference marker, with bubble level
9. **AA 7621** Henderson MICS capsule polisher
10. **AA 8005** Sterilization box with silicone mat

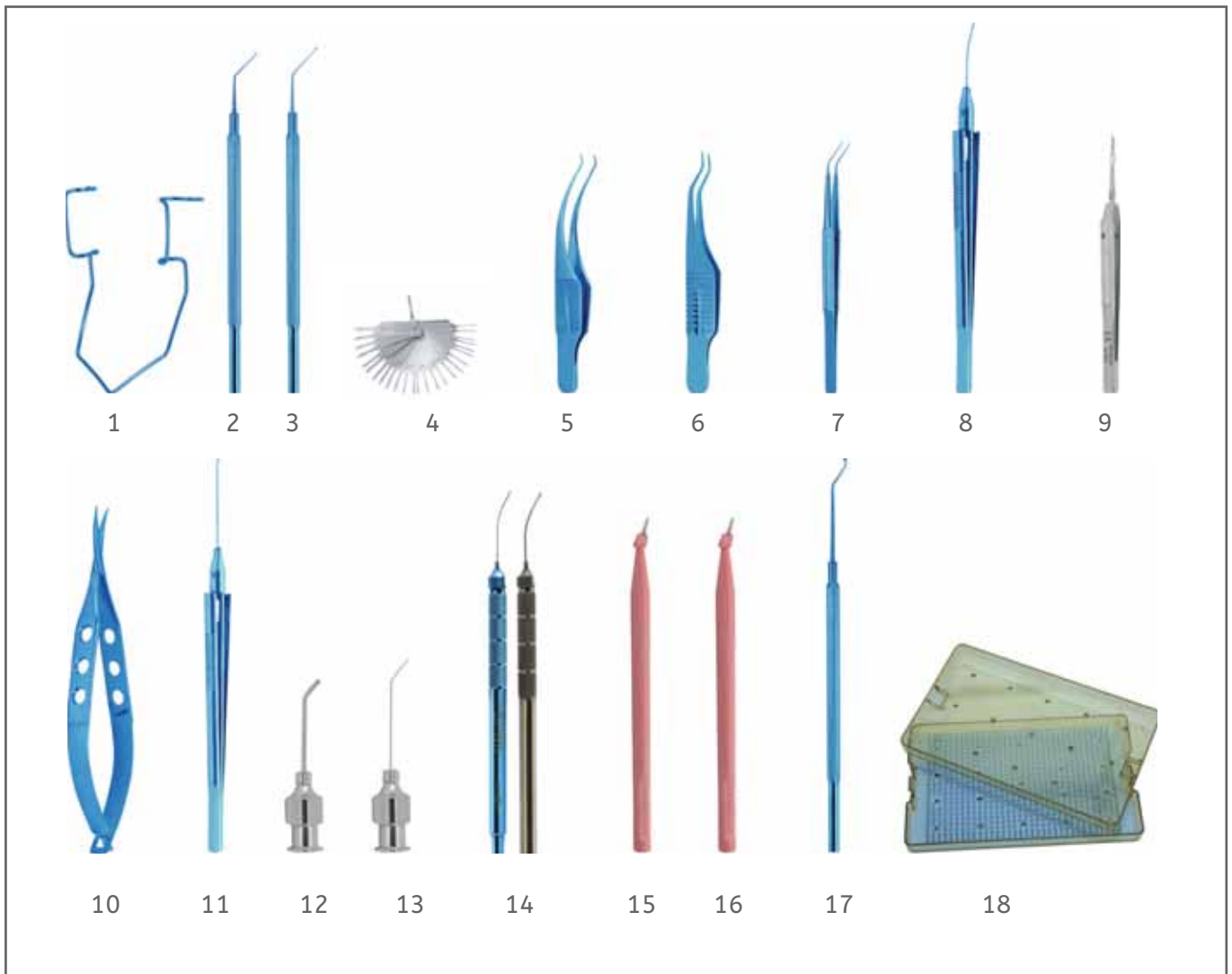

1. **AAT 1025** Kratz -Barraquer wire speculum, big
2. **AAT 1465** Sinsky II lens manipulating hook angled
3. **AAT 1993** Agarwal phaco chopper 1mm fully cutting edge
4. **AA 2102** Appasamy incision gauge (0.80mm to 3.2mm)
5. **AAT 3030** Colibri forceps 1 x 2 teeth 0.12mm
6. **AAT 3805** McPherson IOL forceps, 11mm angled
7. **AAT 3868** Utrata capsulorhexis forceps, round handle, extra delicate
8. **AAT 3872** Kreshner micro incision capsulorhexis forceps, curved 23 G
9. **AA 3913** Akahoshi super combo prechopper
10. **AAT 4155** Westcott tenotomy scissors
11. **AAT 4461** Vitreous scissors angled, 20 G
12. **AA 7105** Rycroft air injection cannula, 23 G
13. **AA 7205** Pearce hydrodissection cannula, 25 G
14. **AAT 7410/11** I/A Bimanual set
15. **AA 572014** Ultra thin phaconit Knife, 1.4mm
16. **AA 572018** Ultra thin phaconit Knife, 1.8mm
17. **AAT 1597A** Akahoshi nucleus ring sustainer
18. **AA 8200** Plastic sterilization box with silicone mat

Guidelines for instruments for handling and caring

- » We congratulate you for selecting “APPASAMY” Ophthalmic Micro surgery instruments, manufactured with extra care. The following suggestions will help you to maintain life of instruments and quality.
- » Inspect instruments immediately on receipt, of first hand observation by yourself.
- » Store instruments in protective containers in which they will be sterilized. Ensure instruments stored in these containers do not contact each other. Also provide correct size soft silicone mats in this sterilizing containers.
- » Use protective tip guards of recommended grade (soft silicone autoclavable material)
- » Never sterilize titanium and stainless steel instruments together.
- » Make it practice to inspect every delicate instruments at the end of surgery.
- » Clean manually using mild soap solution with a soft bristle tooth brush to remove stains.
- » Use distilled or demineralized water to rinse instruments thoroughly and dry them with a hot air blower leaving no trace of water.
- » Do not allow medicines/saline solutions or any protein residue to dry on instruments.
- » Alternatively ultrasonic cleaning method can be used which gives best result. Strictly adhere to the ultrasonic manufactures instructions while using this method use specific cleaning solutions. Change the solutions frequently. Always use DM or distilled water.
- » Use only silicone or Teflon base lubricants if at all you wish to lubricate any of your instruments. Do not use ordinary lubricants.
- » Never cover up corrosion with lubricating die, which may cause severe damage to the instruments while autoclaving
- » Clean and rinse your instrument before sterilizing. Use any of sterilizing methods viz. Steam autoclaving, ethylene oxide gas, or dry hot air, according to your institution’s standards.

Replacement

Our micro surgical instruments are produced with clinical precision and undergo strenuous quality checks at every stage. The instruments will be replaced free of charge, in case of any manufacturing defects due to workmanship of material, notified within 15days from the date of purchase. Please clearly quote catalogue number, batch/lot number printed on the packing sticker and also purchase references of SUBJECT INSTRUMENT DURING TRANSACTION FOR TRACEABILITY.

A/C Maintainer Lewicky cannula	144	Aspirator Subretinal	174	cannulas Soft tip	169
Adson Fixation forceps	79	Asymmetrical End gripping forceps	107	Capsule forceps Arruga	82,83
Adson Fixation forceps	81	Atkinson Peribulbar Needle	157	Capsule forceps Elschnig	82
Advancement forceps Prince	83	Atkinson Retrobulbar needle	157	capsule polisher Capsulorhexis and posterior, Lahad	161
Advancement forceps Worth	83	Ayer Chalazion forceps	84	Capsule polisher Jensen	159
Agarwal Glued IOL Forceps	108	B		Capsule polisher Knolle	159
Air injection cannula DALK	142	Baby Jones Towel clamp forceps	104	Capsule staining cannula Khokkar	159
Air injection cannula Rainin	145	Back flush needle Packo	167	Capsule tag forceps Kraff	95
Air injection cannula Rycroft	142	Backflush Handle, Reusable	172	Capsulorhexis cystotome	159
Akahoshi Capsulorhexis forceps	95	Backhaus Towel clamp	103	Capsulorhexis Forceps	96
Akahoshi Hydrodissection cannula	148	Bailey Lacrimal cannula	141	Capsulorhexis forceps Akahoshi	95
Akahoshi Nucleus fragment removal forceps	99	Banaji LASIK Cannula	166	Capsulorhexis forceps Inamura	95
Akahoshi Nucleus splitter forceps	99	Barraquer Cilia forceps	82	Capsulorhexis forceps Jaffe	97
Akahoshi pre chopper	100, 101	Barraquer Colibri Forceps	74	Capsulorhexis forceps Masket	97
Akahoshi Ring Levitator	161	Bartz-Schmidt Cannula	156	capsulorhexis forceps Micro incision Kreshner	97
Akahoshi Visco cannula	159	Battle Eyelid Compression Forceps	85	Capsulorhexis forceps Nevyas	96
Alabama Utility forceps	99	Bechert IOL cannula	164	Capsulorhexis forceps Pierce	96
Alfonso-McIntyre Irrigating nucleus spoon	161	Beer Cilia forceps	82	Capsulorhexis forceps Utrata	95,96
Allis Tissue forceps	102, 103	Berke Ptosis forceps	84	Carter LASIK cannula	147
Alpha-Chymotrypsin cannula Troutman	150	Bevel Long needle	157	Castroviejo Colibri forceps	76
Anel Lacrimal cannula	141	Bevel Short needle	157	Castroviejo Cyclodialysis cannula	164
Anesthesia cannula Sub tenon	146	Bimanual	189, 190	Castroviejo Suturing forceps	78
Anis Corneal forceps	76	Bimanual Irrigating cannula	146	Chalazion forceps Ayer	84
Anis Cortex aspirating cannula	149	Binkhorst Irrigating cannula	147	Chalazion forceps Desmarres	85
Anis Irrigating vectis	162	Birk Colibri forceps	74	Chalazion forceps Hunt	85
Anis Lens holding forceps	85	Bishop-Harmon Anterior chamber cannula	143	Chalazion forceps Lambert	84
Anterior capsule scrubber Simcoe	160	Bishop-Harmon Dressing forceps	78	chamber maintainer Brierley cannula	144
Anterior chamber Blumenthal cannula	144	Bishop-Harmon Tissue forceps	78	Chang Cannula	148
Anterior Chamber Cannula	143	Blaydes Lens holding forceps	86	Chang Hydrodissection cannula	161
Anterior chamber cannula Arbisser	146	Blumenthal Anterior chamber cannula	144	Charles flute cannulas	169
Anterior chamber cannula Bishop-Harmon	143	Blumenthal cannula	144-145	Charles Flute needle cannula	168
Anterior chamber cannula Bracken	143	Blunt Irrigating cystotome	159	Cheatle forceps Appasamy	103
Anterior chamber cannula McIntyre	142	Bonaccolto Utility forceps	81	Chu Foldable lens	88
Anterior chamber cannula McIntyre	143	Bonn Corneal forceps	77	Chu Hydro-dissection cannula	145
Anterior chamber Knolle	143	Bores Fixation forceps	80	Cilia forceps Barraquer	82
Anterior chamber maintainer Girard cannula	144	Bores Incision spreading forceps	101	Cilia forceps Beer	82
Anterior Chamber Washout cannula	143	Botvin Iris forceps	73	Cilia forceps Gradle	82
Appasamy Aspirating handle	151	Bracken Anterior chamber cannula	143	Clayman Lens holding forceps	86
Appasamy Cheatle forceps	103	Brierley chamber maintainer cannula	144	Co- Axial I/A handpieces	191, 192
Appasamy Irrigating handle	151	Brush tip cannulas	169	Coaxial irrigating- aspirating system McIntyre	150
Appasamy Lens Cutter	89	Bulb with adaptor Silicone	165	Colibri Forceps	74
Appasamy Lens folding forceps	91,92	Buratto LASIK cannula	165	Colibri forceps Birk	74
Appasamy Lens implantation forceps	91	Buratto LASIK cannula	166	Colibri forceps Castroviejo	76
Appasamy Lens inserting forceps	91	Buratto LASIK flap forceps	97	Colibri forceps Nordan	75
Appasamy Needle	157	Burk Irrigating	156	Colibri forceps Tennant - Maumenee	76
Appasamy Sponge holding forceps	104	Burk Peribulbar needle	157	Collar button polisher Graether	160
Appasamy Universal lens folding	91	C		Compression Forceps Battle Eyelid	85
Appasamy Universal lens injector	90	Cannula Bartz-Schmidt	156	Conjunctival suture forceps Moorfield	82
Appasamy Universal lens inserting forceps	92	cannula Blumenthal	144-145	Corneal fixation forceps Kramer	80,81
Arbisser Anterior chamber cannula	146	Cannula Chang	148	Corneal forceps Anis	76
Arita Meibomian Gland Compressor	85	Cannula Enzyme	156	Corneal forceps Bonn	77
Arruga Capsule forceps	82,83	cannula Healon	150	Corneal forceps Hoffer - McPherson	77
Aspirating cannula	149	Cannula Infusion	171	Corneal forceps Kelman - McPherson	77
Aspirating cannula Gills	148	cannula Irrigating	156	Corneal forceps McPherson	77
Aspirating cannula Morrison	149	Cannula LASIK	165	Corneal forceps Pierse	75
Aspirating cannula Roider	156	Cannula needle Subretinal injection	168	Corneal suture & fixation forceps Jayle	82
Aspirating cannula Salz	148	Cannula Trocar Infusion	170	Corneoscleral forceps Lims	77
Aspirating cannula Weber	150	Cannula Viscoelastic	165	Cortex aspirating cannula Anis	149
Aspirating cannula Weber	150	cannulas Brush tip	169	Cortex aspirating cannula Gimbel	149
Aspirating handle Appasamy	151	cannulas Diamond dusted soft tip	169	Cortex extractor cannula Simcoe	149

Cortex extractor cannula Simcoe - Welsh	149	Faulkner Lens holding forceps	88	Gills Irrigating / aspirating cannula	152
Cortex extractor Simcoe	161	Faulkner Lens inserting forceps	89	Gills-Welsh Irrigating / aspirating cannula	154
Crocodile Gripping Forceps	105	Feaster Hydrodissection cannula	145	Gimbel Cortex aspirating cannula	149
CTR Injector	90	femtosecond cannula Slade	146	Gimbel LASIK Fountain Cannula	166
Cutting forceps Foldable Lens	89	Fine colibri beaked forceps Pierse Type	76	Gimbel 'U' shaped hydrodissector	145
Cyclodialysis cannula Castroviejo	164	fixation & Corneal suture forceps Jayle	82	Girard Anterior chamber maintainer cannula	144
Cyclodialysis cannula flattened Sheets	164	Fixation Forceps	79	Gland Compressor Arita Meibomian	85
Cyclodialysis cannula Gans	164	Fixation Forceps	79	Gradle Cilia forceps	82
Cyclodialysis cannula Kelman	164	Fixation forceps Adson	79	Graefe Fixation forceps	79
Cyclodialysis cannula Randolph	164	Fixation forceps Bores	80	Graether Collar button polisher	160
cystotome Capsulorhexis	159	Fixation forceps Elschnig	79	Grandon I/A cannula Gently curved	154
Cystotome Double Edge	159	Fixation forceps Graefe	79	Grandon I/A cannula slightly	155
Cystotome Double Edge sharp	159	Fixation forceps Green	80	Green Fixation forceps	80
cystotome Irrigating	158	Fixation forceps Lester	80	Gripping Angled Forceps	106
Cystotome Kelman	158	Fixation forceps Moody	80	G	
Cystotome Knolle - Kelman	158	Fixation Plate Trocar	170	H.K.Punch	99
Cystotome Kratz	158	Flap forceps LASIK Buratto	97	Halsted Mosquito forceps	102
Cystotome McIntrye	147	Flat olive tip cannula Welsh	150	Halsted Mosquito forceps	103
Cystotome McIntrye	158	Fluid drainage needle Subretinal	173	Harms Tying forceps	93
D		Flute cannulas Charles	169	Harms-Colibri Suturing forceps	74
DALK Air injection cannula	142	Flute needle cannula Charles	168	Hartman Mosquito forceps	102
DALK cannula Rosenwasser	142	Foldable IOL forceps Kellan	90	Healon cannula	150
Dastoor Superior rectus forceps	80	Foldable lens Chu	88,89	Healon Vitreous aspiration cannula	148
Desmarres Chalazion forceps	85	Foldable Lens Cutter	89	Henderson MICS capsule polishing cannula	160
Diamond dusted soft tip cannulas	169	Foldable Lens Cutting forceps	89	Heslin Infusion cannula	144
Diamonized Gripping Forceps	105	Foldable Lens Removing Forceps	89	Hess Extra capsular forceps	83
Diopter Irrigating contact lens	172	Foldable lens Ultrata	88	Hess Iris forceps	73
Disposable Instruments	194to209	Forceps Forceps	98	High Viscosity Injector Cannula	157
DMEK Cannula	143	Forceps Barraquer Colibri	74	Hoffer - McPherson Corneal forceps	77
Dodick Lens holding forceps	86	Forceps Capsulorhexis	96	Hoffman Nucleus loop	163
Dodick Nucleus cracking forceps	99	Forceps Colibri	74	Hunt Chalazion forceps	85
Donnenfeld Micro IOL holding forceps	92	Forceps Crocodile Gripping	105	Hydrodelineation cannula Kellan	146
Donnenfeld Micro soft IOL cutter	92	Forceps Diamonized Gripping	105	Hydrodissection cannula Akahoshi	148
Double blade cystotome Kelman	158	Forceps DSEK	89	Hydrodissection cannula Chang	161
Double corneal forceps Polack	74	Forceps End Gripping	105	Hydro-dissection cannula Chu	145
Double Edge Cystotome	159	Forceps Eye Dressing	81	Hydrodissection cannula Feaster	145
Double Edge Cystotome sharp	159	Forceps Fixation	79	Hydrodissection cannula Feaster	145
Dressing forceps Adson	81	Forceps Fixation	79	Hydrodissection cannula Pearce	145
Dressing forceps Bishop-Harmon	78	Forceps Foreign Body	99	Hydrodissection cannula Sautter	147
Drews Irrigating vectis	162	Forceps Gill-Colibri	74	Hydrodissection cannula Sautter	148
Drews Posterior capsule polisher	160	Forceps Gripping Angled	106	Hydrolysis Needle Nucleus	146
DSEK forceps	89	Forceps Iris	78	H	
D		Forceps Iris	73	I/A prob	191, 192
Elschnig Capsule forceps	82	forceps Pierse type	76	ICSR Implant Forceps	86
Elschnig Fixation forceps	79	forceps Scleral plug	169	ILM forceps Kawai	107
End Gripping Forceps	105	Forceps Sleeve spreading Watzke	169	Inamura Capsulorhexis forceps	95
End gripping forceps Asymmetrical	107	Forceps Trachoma	84	Inamura Eagle Pre Chopper	101
Endocapsular IOL Insertion forceps Kellan	86	Forceps Trocar Loading	170	Incision spreading forceps Bores	101
Endothelial Gripping Forceps	108	Forceps Vitreous	105, 106	Infusion Cannula	171
Entropium forceps Snellen	84	Foreign Body Forceps	99	Infusion cannula Heslin	144
Enzyme Cannula	156	Foreign Body Forceps	107	Infusion Cannula Self-Retaining Sutureless	171
Erhardt Lid forceps	84	Freeman Posterior capsule polisher	161	Infusion Cannula Silicone Oil	171
Expressor Forceps Tearse Meibum	85	G		Infusion Needle 30 Degree Bent May	173
Expressor Paddle Meibomian	85	Gans Cyclodialysis cannula	164	Injection cannula Viscoelastic	148
Extra capsular forceps Hess	83	Gess Irrigating /aspirating cannula	155	Injector Cannula High Viscosity	157
Extrusion hand piece cannula Tapered	168	Giannetti MICS capsulorhexis forceps	96	IOL cannula Bechert	164
Eye Dressing Forceps	81	Gill Iris forceps	73	IOL forceps Kelman-McPherson	94
F		Gill-Colibri Forceps	74	IOL forceps McPherson	94
Fasanella Lacrimal cannula	142	Gills - Welsh Olive tip cannula	150	IOL Glide	145
Faulkner II Lens inserting forceps	90	Gills Aspirating cannula	148	Iridectomy Forceps	108

Iris Forceps	73	Kellan Hydrodelineation cannula	146	Lens Handle Vitreo	172
Iris forceps Botvin	73	Kelman - McPherson Corneal forceps	77	Lens holding forceps Anis	85
Iris forceps Gill	73	Kelman Cyclodialysis cannula	164	Lens holding forceps Blaydes	86
Iris forceps Hess	73	Kelman Cystotome	158	Lens holding forceps Clayman	86
Iris forceps Kirby	79	Kelman Double blade cystotome	158	Lens holding forceps Dodick	86
Iris forceps Osher	98	Kelman-McPherson IOL forceps	94	Lens holding forceps Faulkner	88
Iris forceps Swiss Model	73	Khokkar Capsule staining cannula	159	Lens holding forceps Kraff	86
Irrigating / aspirating cannula Gills	152	Kirby Iris forceps	79	Lens holding forceps Kratz	87
I/A cannula Gills-Welsh	154	Knolle - Kelman Cystotome	158	Lens holding forceps Shepard	87
I/A cannula Morrison	153	Knolle Anterior chamber	143	Lens holding forceps Sinsky	87
I/A cannula Reverse Simcoe	151	Knolle Capsule polisher	159	Lens implant forceps Simcoe II	87
I/A cannula Ruit	153	Knolle-Pearce Irrigating vectis	162	Lens implantation forceps Appasamy	91
I/A cannula Simcoe	151	Kraff Capsule tag forceps	95	Lens inserting forceps Appasamy	91
I/A cannula Simcoe Reverse model	152	Kraff Lens holding forceps	86	Lens inserting forceps Faulkner	89
I/A cannula Simcoe sand blasted	151	Kraff Posterior capsule	160	Lens inserting forceps Faulkner II	90
I/A cannula Swiss	152	Kramer Corneal fixation forceps	80,81	Lens manipulating cannula Kratz	163
I/A cannula Gess	155	Kratz Cystotome	158	Lens manipulating cannula Osher	164
I/A cannula Grandon Gently curved	154	Kratz Lens holding forceps	87	Lens manipulating cannula Youens	163
I/A cannula Grandon slightly	155	Kratz Lens manipulating cannula	163	Lens Removing Forceps Foldable	89
I/A cannula Jensen-Thomas	154	Kratz Posterior capsule	160	Lester Fixation forceps	80
Irrigating Burk	156	Kreshner Micro incision capsulorhexis forceps	97	Levigator Akahoshi Ring	161
Irrigating cannula	156	Kritzinger spiration of BSS fluid	166	Lewicky A/C Maintainer cannula	144
Irrigating cannula Bimanual	146	Kuglen Irrigating lens manipulator	163	Lid forceps Erhardt	84
Irrigating cannula Binkhorst	147	L		Lieberman Lens forceps	87
Irrigating cannula McIntyre-Binkhorst	147	Lacrimal Cannula	141	Lieberman Micro-ring lens forceps	88
Irrigating cannula Rubenstein LASIK	167	Lacrimal cannula Anel	141	Lims Corneoscleral forceps	77
Irrigating cannula West	146	Lacrimal cannula Bailey	141	Lims Suturing forceps	77
Irrigating cannula Wilbrandt-Binkhorst	147	Lacrimal cannula Fasanella	142	Loading forceps Lens Cartridge	107
Irrigating capsule retractor Nishi	146	Lacrimal cannula McIntyre	141	Loading Forceps Trocar	88
Irrigating capsule retractor Salz	147	Lacrimal cannula Reinforced	142	Long needle Bevel	157
Irrigating choppers	193	Lacrimal cannula Reinforced	142	M	
Irrigating contact lens 45 Diopter	172	Lacrimal cannula Shahinian	141	MaCulorhexis forceps Tanaka	107
Irrigating contact lens 90 Diopter	172	Lacrimal cannula Tulevech	141	Masket Capsulorhexis forceps	97
Irrigating cystotome	158	Lacrimal cannula West	142	Maumenee Vitreous aspirating cannula	148
Irrigating cystotome Blunt	159	Lahane Capsulorhexis and posterior capsule polisher	161	May 30 Degree Bent Infusion Needle	173
Irrigating handle Appasamy	151	Lambert Chalazion forceps	84	McIntyre Anterior chamber cannula	142
Irrigating lens manipulator Kuglen	163	Large Foreign Body Forceps	108	McIntyre Anterior chamber cannula	143
Irrigating Micro retinal pick	173	LASIK cannula Buratto	166	McIntyre Coaxial irrigating- aspirating system	150
Irrigating nucleus spoon Alfonso-McIntyre	161	LASIK Cannula Gimbel Fountain	166	McIntyre Cystotome	147
Irrigating vectis Anis	162	LASIK Cannula	165	McIntyre Cystotome	158
Irrigating vectis Drews	162	LASIK Cannula Banaji	166	McIntyre Lacrimal cannula	141
Irrigating vectis Knolle-Pearce	162	LASIK cannula Buratto	165	McIntyre-Binkhorst Irrigating cannula	147
Irrigating vectis Micro	163	LASIK cannula Carter	147	McPherson Corneal forceps	77
Irrigating vectis Sheets	162	LASIK cannula Spatulated	167	McPherson IOL forceps	94
J		LASIK cannula Zirm	162	McPherson Tying forceps	93,94
'J' shaped I/A Cannula	155-156	LASIK dissector cannula Zirm	162	Meibomian Expressor Paddle	85
Jacobi Trabecular aspirating cannula	149	LASIK flap forceps Buratto	97	Membrane Peeler	173
Jaffe Capsulorhexis forceps	97	LASIK flap irrigator Parallel cannula Vidaurri	165	Micro forceps Pierse Type	75
Jaffe Tying forceps	92	LASIK forceps Multi Purpose	97	Micro incision capsulorhexis forceps Kreshner	97
Jameson Muscle forceps	83	LASIK forceps Perone	97	Micro IOL holding forceps Donnenfeld	92
Jayle Corneal suture & fixation forceps	82	LASIK irrigating cannula Nichamin	166	Micro Irrigating vectis	163
Jayle Tying forceps	93	LASIK irrigating cannula Nichamin	166	Micro retinal pick Irrigating	173
Jensen Capsule polisher	159	LASIK irrigating cannula Quad ported	165	Micro soft IOL cutter Donnenfeld	92
Jensen-Thomas Irrigating /aspirating cannula	154	LASIK Irrigating cannula Zirm	162	Micro 'U' shaped aspirating cannula	150
Jewelers Forceps	98	Lens Cartridge Loading forceps	107	Micro-ring lens forceps Lieberman	88
K		Lens Cutter Appasamy	89	MICS capsule polishing cannula Henderson	160
Kansas Nucleus fragment removal forceps	100	Lens Cutter Foldable	89	MICS capsulorhexis forceps Giannetti	96
Kawai ILM forceps	107	Lens Folder and Pusher	90	Moody Fixation forceps	80
Kellan Endocapsular IOL Insertion forceps	86	Lens folding forceps Appasamy	91,92	Moorfield Conjunctival suture forceps	82
Kellan Foldable IOL forceps	90	Lens forceps Lieberman	87	Morrison Aspirating cannula	149

Morrison Irrigating / aspirating cannula	153	Posterior capsule scrubber Simcoe	161	Sinsky Lens holding forceps	87
Mosquito forceps Halsted	103	Pre chopper Akahoshi	100, 101	Sinsky Tying forceps	94
Mosquito forceps Halsted	102	Pre Chopper Inamura Eagle	101	Slade femtosecond cannula	146
Mosquito forceps Hartman	102	Pressure Line Adapter	167	Small incision nucleus Delivery cannula	163
Multi Purpose LASIK forceps	97	Prince Advancement forceps	83	Smooth jaws Vitreous Forceps	104
Muscle forceps Jameson	83	Ptois forceps Berke	84	Snellen Entropium forceps	84
N		Pusher and Lens Folder	90	Snider-Castroviejo Suturing forceps	79
Needle	141	Q		Soft tip cannulas	169
Needle Holder Ring Type	104	Quad ported LASIK irrigating cannula	165	Spatulated LASIK cannula	167
Nevyas Capsulorhexis forceps	96	R		Sponge holding forceps Appasamy	104
Nevyes-Wallace Fixation Forceps	81	R.K cannula Shepard	143	Spring Gripping Forceps	108
Nichamin LASIK irrigating cannula	166	Rainin Air injection cannula	145	St.Martin Suturing forceps	79
Nichamin LASIK irrigating cannula	166	Randolph Cyclodialysis cannula	164	Sub Retinal Cannulas	175
Nishi Irrigating capsule retractor	146	Reinforced Lacrimal cannula	142	Sub Retinal Forceps	106
Nishi Nucleus delivery cannula	163	Removal forceps Nucleus fragment Akahoshi	99	Sub tenon Anesthesia cannula	146
Nordan Colibri forceps	75	Removal forceps Suture	99	Subretinal Aspirator	174
Nucleus cracking forceps Dodick	99	Retinal Cannulas	175	Subretinal Fluid drainage needle	173
Nucleus delivery cannula Nishi	163	Retrolubar needle Atkinson	157	Subretinal fluid Packo	168
Nucleus delivery cannula Simcoe	162	Reusable Backflush Handle	172	Subretinal injection Cannula needle	168
Nucleus Delivery cannula Small incision	163	Reverse Simcoe Irrigating / Aspirating cannula	151	Superior rectus forceps Dastoor	80
Nucleus fragment removal forceps Akahoshi	99	Ring Type Needle Holder	104	Suture Removal forceps	99
Nucleus fragment removal forceps Kansas	100	Roider Aspirating cannula	156	Suturing forceps Castroviejo	78
Nucleus Hydrolysis Needle	146	Rosenwasser DALK cannula	142	Suturing forceps Harms-Colibri	74
Nucleus irrigating cannula Thurmond	147	Rubenstein LASIK Irrigating cannula	167	Suturing forceps Lims	77
Nucleus loop Hoffman	163	Rubman - Katzin Posterior capsule polisher	160	Suturing forceps Snider-Castroviejo	79
Nucleus spatula Simcoe	165	Ruit Irrigating / aspirating cannula	153	Suturing forceps St.Martin	79
Nucleus splitter forceps Akahoshi	99	Rycroft Air injection cannula	142	Swiss Irrigating / aspirating cannula	152
O		S		Swiss Model Iris forceps	73
Oil Removal Cannula Silicone	157	Salz Aspirating cannula	148	T	
Olive tip cannula Gills - Welsh	150	Salz Irrigating capsule retractor	147	Tanaka Maculorhexis forceps	107
Osher Iris forceps	98	Sautter Hydrodissection cannula	147	Tapered Extrusion hand piece cannula	168
Osher Lens manipulating cannula	164	Sautter Hydrodissection cannula	148	Tearse Meibum Expressor Forceps	85
P		Scleral plug forceps	169	Tennant - Maumenee Colibri forceps	76
Packo Back flush needle	167	Scleral Plugs	171	Tennant Tying forceps	93
Packo needle Subretinal fluid drainage	173	Self-Retaining Sutureless Infusion Cannula	171	Thurmond Nucleus irrigating cannula	147
Packo Pars plana cannula	167	Serrated jaws Serrefine	104	Tissue forceps Allis	102, 103
Packo Subretinal fluid	168	Serrefine Serrated jaws	104	Tissue forceps Bishop-Harmon	78
Packo Subretinal fluid drainage needle	173	Shahinian Lacrimal cannula	141	Towel clamp Backhaus	103
Pars plana cannula Packo	167	Shapiro Posterior capsule polisher	160	Towel clamp forceps Baby Jones	104
Pearce Hydrodissection cannula	145	Sheets Cyclodialysis cannula flattened	164	Trabecular aspirating cannula Jacobi	149
Peribulbar Needle Atkinson	157	Sheets Irrigating vectis	162	Trachoma Forceps	84
Peribulbar needle Burk	157	Shepard Lens holding forceps	87	Trocar Cannula System	170
Perone LASIK forceps	97	Shepard R.K cannula	143	Trocar Fixation Plate	170
Phaco Tip	188	Short needle Bevel	157	Trocar Infusion Cannula	170
Pick Forceps	106	Silicone Bulb with adaptor	165	Trocar Loading Forceps	88
Pierce Capsulorhexis forceps	96	Silicone Oil Infusion Cannula	171	Trocar Loading Forceps	170
Pierce Corneal forceps	75	Silicone Oil Removal Cannula	157	Troutman Alpha-Chymotrypsin cannula	150
Pierce Type Fine colibri beaked forceps	76	Silicone tube	165	Tulevech Lacrimal cannula	141
Pierce type forceps	76	Simcoe - Welsh Cortex extractor cannula	149	Tying forceps Harms	93
Pierce Type Micro forceps	75	Simcoe Anterior capsule scrubber	160	Tying forceps Jaffe	92
Plugs Scleral	171	Simcoe Cortex extractor	161	Tying forceps Jayle	93
Polack Double corneal forceps	74	Simcoe Cortex extractor cannula	149	Tying forceps McPherson	93,94
Posterior	167	Simcoe II Lens implant forceps	87	Tying forceps Sinsky	94
Posterior capsule Kraff	160	Simcoe I/A cannula	151	Tying forceps Tennant	93
Posterior capsule Kratz	160	Simcoe I/A cannula Reverse model	152	U	
Posterior capsule polisher Drews	160	Simcoe I/A cannula sand blasted	151	U' shaped aspirating cannula Micro	150
Posterior capsule polisher Freeman	161	Simcoe Nucleus delivery cannula	162	Universal lens folding Appasamy	91
Posterior capsule polisher Rubman - Katzin	160	Simcoe Nucleus spatula	165	Universal lens injector Appasamy	90
Posterior capsule polisher Shapiro	160	Simcoe Posterior capsule polisher	161	Universal lens inserting forceps Appasamy	92
Posterior capsule polisher Simcoe	161	Simcoe Posterior capsule scrubber	161	Utility forceps Alabama	99

Utility forceps Bonaccolto	81
Utility forceps Wills Hospital	81
Utrata Capsulorhexis forceps	95,96
Utrata Foldable lens	88
Vidaurri LASIK flap irrigator Parallel cannula	165
Visco cannula Akahoshi	159
Viscodissector cannula Vitreo Retinal	173
Viscoelastic Cannula	165
Viscoelastic Injection cannula	148
vitrectomy cutter 20 PSI	167
Vitreo Lens Handle	172
Vitreo Retinal Viscodissector cannula	173
Vitreoretinal Cannula	174
Vitreous aspirating cannula Maumenee	148
Vitreous aspiration cannula Healon	148
Vitreous Forceps	105, 106
Vitreous Forceps Smooth jaws	104
Wallace Fixation Forceps Nevyes	81
Washout cannula Anterior Chamber	143
Watzke Sleeve spreading forceps	169
Weber Aspirating cannula	150
Weber Aspirating cannula	150
Welsh Flat olive tip cannula	150
West Irrigating cannula	146
West Lacrimal cannula	142
Wilbrandt-Binkhorst Irrigating cannula	147
Wills Hospital Utility forceps	81
Worth Advancement forceps	83
Youens Lens manipulating cannula	163
Zirm LASIK dissector cannula	162
Zirm LASIK Irrigating cannula	162

NOTES:

Ophthalmic Instruments Catalogue

More than
40 Years in
Ophthalmology

QUALITY | SERVICE | INTEGRITY

